

# ENERPAC®

POWERFUL SOLUTIONS. GLOBAL FORCE.



US

E 2 1 5

## WORKHOLDING

# Model number index

series	page	series	page	series	page	series	page
<b>A</b>		<b>I</b>		<b>S</b>		<b>VS</b>	
A.....	192	IC.....	188	SC.....	38	VS.....	147
ACBS.....	164-165	<b>L</b>		SCLD.....	30-31	VSS.....	140
ACCB.....	174-175	LCAL.....	56-57	SCLS.....	30-31	VST.....	140
ACL.....	162-163	LCAS.....	56-57	SCRD.....	30-31	<b>W</b>	
ACM.....	162-163	LUCD.....	54-55	SCRS.....	30-31	WA.....	162-163
AD.....	85	LUCS.....	54-55	SCSD.....	30-31	WAT.....	163
AH.....	192	<b>M</b>		SCSS.....	30-31	WCA.....	174-175
AHB.....	104-105	MB.....	144	SLDB.....	180	WED.....	110-113
AMP.....	176-177	MCH.....	166-167, 169	SLEB.....	180-183	WEJ.....	110-113
AP.....	164-165	MCPS.....	166-167, 169	SLEM.....	180-183	WEM.....	110-113
AR.....	192	MCR.....	166-170	SLLD.....	26-27	WER.....	110-113
ASC.....	39	MCRA.....	166-170	SLLS.....	26-27	WES.....	110-113
AT.....	175	MCRC.....	166-170	SLR.....	180-183	WFC.....	45-47, 50-51
AW.....	87, 163	MCSB.....	166-167, 169, 171	SLRD.....	26-27	WFL.....	46-47, 50
<b>B</b>		MF.....	87	SLRS.....	26-27	WFM.....	46-47, 50
B.....	104-105, 172-173	MHV.....	156, 164-165	SLS.....	180-183	WFT.....	46-47
BFZ.....	194-195	MRH.....	78-79	SLSC.....	180-183	WM.....	139
BK.....	147	MRS.....	80-81	SLSD.....	26-27	WMT.....	68-69
BKD.....	145	MRW.....	82-83	SLSS.....	26-27	WPA.....	174-175
BS.....	86	MV.....	153	SP.....	132	WPFC.....	18-19
<b>C</b>		MVM.....	153	STLD.....	23, 28-29	WPFL.....	12-13
CA.....	14	MVPC.....	152	STLS.....	23, 28-29	WPFR.....	12-13
CAC.....	34-35	MVPM.....	152	STRD.....	23, 28-29	WPFS.....	16-17
CAL.....	32-33	<b>N</b>		STRS.....	23, 28-29	WPTC.....	18-19
CAPT.....	34-35	NV.....	191	STSD.....	23, 28-29	WPTL.....	12-13
CAS.....	32-33	<b>P</b>		STSS.....	23, 28-29	WPTS.....	16-17
CAU.....	36-37	P.....	132	SULD.....	23, 24-25	WRT.....	68-69
CDB.....	72-75	PA.....	103	SULDL.....	23, 24-25	WSC.....	48-49, 51
CDF.....	175	PACG.....	98-101	SULS.....	24-25	WSL.....	48-50
CDM.....	175	PAMG.....	98-101	SURD.....	23, 24-25	WSM.....	48-50
CDT.....	66-67	PARG.....	98-101	SURL.....	23, 24-25	WST.....	48-49
CR.....	176-177	PASG.....	98-101	SURS.....	23, 24-25	WTR.....	40-42
CRV.....	176-177	PATG.....	98-101	SUSD.....	24-25	WUD.....	108-109
CSB.....	72-75	PB.....	139, 188	SUSDL.....	24-25	WVP.....	152, 159
CSM.....	70-71	PID.....	178-179	SUSS.....	24-25	<b>Y</b>	
CST.....	66-67	PLSD.....	59, 62-63	<b>T</b>		Y.....	86
CY.....	78-79	PLSS.....	59, 62-63	T.....	192	<b>Z</b>	
CYDA.....	68-69	PLV.....	156-157	TRCM.....	88-90	ZAJ.....	102
<b>D</b>		PRV.....	138, 141-142, 154	TRFM.....	88-89, 91	ZHE.....	119
DGR.....	189	PSCK.....	137, 188	TRFL.....	88-89, 92	ZLS.....	120
<b>E</b>		PTSD.....	59, 64-65	TRRC.....	93	ZPF.....	118
ECH.....	76-77	PTSS.....	59, 64-65	TRRE.....	93	ZPS.....	120
ECM.....	76-77	PUSD.....	59-61	TRAC.....	93	ZPT.....	120
<b>F</b>		PUSS.....	59-61	TRK.....	139	ZW.....	114-131, 174
FL.....	193	<b>Q</b>		<b>V</b>		1531R.....	190
FM.....	191	QDH.....	78-79	V.....	106-107, 145, 152-153, 156-157, 191	1533R.....	190
FN.....	86	QE.....	106-107, 158	VA.....	106-107, 158	1534R.....	190
FZ.....	93, 175, 194-196	<b>R</b>		VAS.....	106-107, 140, 158	1535R.....	190
<b>G</b>		R.....	195	VAT.....	140		
G.....	190	RA.....	172-173	VC.....	148-151		
GA.....	191	RD.....	84-85	VD.....	140-142		
GS.....	191	REB.....	82	VE.....	142, 146-147		
<b>H</b>		REP.....	82	VFC.....	137, 141-142, 155		
H.....	192	RFL.....	106-107, 158	VM.....	148-151		
HCS.....	78-79	RW.....	82-83	VMMD.....	143		
HF.....	193	RWH.....	78-79	VMTD.....	143		
HLS.....	192			VP.....	136		
HP.....	79			VP03.....	141		
HV.....	106-107, 156			VR.....	107, 158		

All information in this catalog can be changed due to product improvements without prior notice.

© Copyright 2013, Actuant Corp. All rights reserved. Any copying or other use of material in this catalog (text, illustrations, drawings, photos) without express written consent is prohibited.

## Yellow Pages

Refer to the "Yellow Pages" of this catalog for:

- Safety instructions
- Basic hydraulic information
- Advanced hydraulic technology
- FMS (Flexible Machining Systems) technology
- Conversion charts and hydraulic symbols

product description	series	page
<b>Collet Lok® clamps 8-19</b>		
Collet Lok® Swing Clamp Arms.....	CA	14
Collet Lok® Swing Clamps..WPFL, WPFR, WPTL, WPTR ..		12
Collet Lok® Push Cylinders .....	WPFC, WPTC	18
Collete Lok® Work Supports.....	WPFS, WPTS	16
<b>Swing clamps 20-42</b>		
Pivoting T-Arms.....	CAC/CAPT	34
Swing Clamp Arms .....	CAS/CAL	32
Swing Clamps.....	SC	38
Swing Clamps.....	ASC	39
Swing Clamps, Cartridge Body.....	SC	30
Swing Clamps, Lower Flange.....	SL	26
Swing Clamps, Threaded Body .....	ST	28
Swing Clamps, Upper Flange .....	SU	23
Three-Position Swing Clamp.....	WTR	40
Upreach Arms .....	CAU	36
<b>Work supports 43-51</b>		
Work Supports, Fluid Advance .....	WF	46
Work Supports, Spring Advance.....	WS	48
<b>Linear cylinders 52-93</b>		
Cylinder Accessories, Contact Bolts .....	BS	86
Cylinder Accessories, Jam Nuts .....	FN	86
Cylinder Accessories, Mounting Flanges .....	AW/MF	87
Cylinder Accessories, Yoke .....	Y	86
Cylinders, Block .....	CSB/CDB	72
Cylinders, Hollow Plunger..CY/HCS/MRH/QDH/RWH ..		78
Cylinders, Manifold Mount.....	CSM	70
Cylinders, Positive Clamping.....	MRS	80
Cylinders, Pull Down .....	ECH/ECM	76
Cylinders, Threaded Body.....	CST/CDT	66
Cylinders, Threaded Body.....	CYDA/WMT/WRT	68
Cylinders, Tie Rod.....	TR	88
Cylinders, Tie Rod, Accessories..TRRC/TRRE/TRAC ..		93
Cylinders, Universal Single Acting .....	MRW/RW	82
Cylinders, Universal, Double Acting.....	RD	84
Link Clamp Arms.....	LCAS/LCAL	56
Link Clamps, Upper Flange.....	LUCD/LUCS	54
Pull Cylinders, Lower Flange .....	PL	62
Pull Cylinders, Threaded Body.....	PT	64
Pull Cylinders, Upper Flange.....	PU	60
<b>Power sources 94-133</b>		
Air Hydraulic Boosters.....	AHB/B	105
Air Hydraulic Pump.....	PA	103
Air Powered Pump, Heavy-Duty.....	ZAJ	102
Air Powered Pump, Turbo.....	PAC/PAM/PAR/PAS/PAT	98
Air Valves and Accessories...HV/RFL/QE/V/VAS/VR .....		106
Electric Pumps, Economy .....	WUD	108
Electric Pumps, Submerged .....	WE	110
Hand Pump .....	P, SP	132
ZW Electric Driven Pumps.....	ZW	114, 128
ZW Pump Filter Kit.....	ZPF	118
ZW Pump Heat Exchanger .....	ZHE	119
ZW Pump Level/Temperature Switch .....	ZLS	120
ZW Pump Mounted Manifolds .....	ZW	121
ZW Pump Pressure Switch/Transducer.....	ZPS/ZPT	120
ZW Pump, Continuous Connection .....	ZW	124
ZW Pump, Pallet Coupling .....	ZW	122
ZW Pump, Single Station .....	ZW	126
<b>Valves 134-159</b>		
Flow Control for Solenoid Modular Poppet .....	VFC	137
Flow Control, Dual, for D03/CETOP3.....	VFC	141,142
Flow Control, Inline.....	VFC	155
Inlet Check Valve, D03/CETOP3 .....	VD1P	140
Manifold, Porting, for Solenoid Modular Poppet...PB .....		139
Manifold, Remote, for D03/CETOP3.....	MB	144
Manifold, Remote, for Solenoid Modular Poppet...WM .....		139

product description	series	page
Manual, D03/CETOP3.....	VMMD/VMTD	143
Manual, Pump Mount .....	VM	148-151
Manual, Remote Mount .....	VC	148-151
Mounting Bolt Kit for D03/CETOP3 .....	BKD	145
Mounting Bolt Kit for Solenoid Modular Poppet ..	TRK	139
Mounting Bolt Kit for Solenoid Modular .....	BK	147
Pilot Operated Check for Solenoid Modular .....	VS	147
Pilot Operated Check, Dual, for D03/CETOP3... VD2P .....		142
Pilot Operated Check, Inline, Manifold .....	MV, V	153
Pressure Reducing for D03/CETOP3.....	PRV	141, 142
Pressure Reducing for Solenoid Modular Poppet... PRV .....		138
Pressure Reducing, Inline, Cartridge.....	PRV	154
Pressure Switch for Solenoid Modular Poppet ... PSCK .....		137
Relief Valve for Solenoid Modular .....	VS	147
Sequence, Inline, Manifold, Cartridge... MVP, WVP, V .....		152
Solenoid/ Air Operated 2-Position Poppet, D03/CETOP3 .....	VA, VS	140
Solenoid Modular.....	VE	146
Solenoid Modular Poppet.....	VP	136
Solenoid Poppet, D03/CETOP3.....	VP03	141
Solenoid Spool, D03/CETOP3 .....	VET/VEX/VEW	142
Valve, Accessory .....	V/HV/MHV/PLV	156, 157
Valve, Air Valve and Accessories... RFL/QE/V/VA/VAS/VR .....		158
<b>Palletized fixture components 160-185</b>		
Accumulators .....	ACM/ACL/WA	162
Autocoupler .....	ACCB/WCA/WPA	174
Coupler Packages.....	ACBS/AP/MHV	164
Intensifiers.....	PID	178
Manual Couplers.....	MC	166
Rotary Unions.....	AMP/CR/CRV	176
Safe Link Wireless Monitoring .....	SL	180
Wand and Booster .....	B/RA	172
<b>System components 186-196</b>		
Coupler .....	AH/AR	192
Filter, High Pressure, Inline.....	FL	193
Fittings .....	BFZ/FZ/R	194
Gauge, Digital .....	DGR	189
Gauge .....	G	190
Gauge Accessories.....	FM/GA/GS/NV/V	191
Hose.....	H/HLS	192
Manifold, Multiport.....	A	192
Oil, Hydraulic .....	HF	193
Pressure Switch.....	IC/PSCK	188
Pressure Switch Mounting Block .....	PB	188
Tubing .....	T	192
<b>Yellow pages 197-228</b>		
Basic Hydraulics.....		200-201
Basic System Set-up .....		202-205
Best Practices.....		214
Clamping Technology .....		206-209
Conversion Factors .....		213
Cutting Tool Technology .....		210-212
FMS.....		224
Hydraulic Symbols .....		215
Mechanical Clamping .....		226
Safety Instructions .....		198-199
Valving Technology.....		220

**Collet Lok® Products**  
8-19



**Swing Clamps**  
20-42



**Work Supports**  
43-51



**Linear Cylinders**  
52-93



**Power Sources**  
94-133



**Valves**  
134-159



**Pallet Components**  
160-185



**System Components**  
186-196



**Yellow Pages**  
197-228



# The World Class Brand

**A** complete range of quality Workholding products for all production applications, with local availability and after sale service anywhere in the world....this is what makes Enerpac a global leader in hydraulic Workholding.

Across every continent, Enerpac's network of authorized distributors and service centers provide sales and support of products designed to enhance productivity and performance, while making the work place safer.

With over 150 sales specialists and a network of service and engineering support in 17 countries across the globe, Enerpac is a valuable partner for customers involved in production manufacturing using hydraulic clamping components and those who support them with custom tooling.

Always at the leading edge of technology, Enerpac continues to develop its range of time and cost saving products, utilizing modern engineered materials to improve productivity and minimize operator fatigue.

Enerpac's commitment to the continued development of quality hydraulic Workholding products ensures that the products you purchase are the best in the industry. We will continue to lead the way in the development of quality hydraulic Workholding products for industrial production applications.



# Enerpac Workholding Value Proposition

- Expert Design
- Highly Reliable
- Service Excellence
- Worldwide Experience
- Application Support
- Availability
- Quality
- Value
- Innovative Products
- Systems Solutions



## Total Quality

Our products are tested to the most exacting standards. These high standards guarantee the quality, price and performance requirements of the markets we serve around the globe.

## Global Network

Enerpac has an extensive network of authorized distributors and service centers located in more than 90 countries worldwide. You can rely on Enerpac for the products and technical support you need to get your job done, anywhere in the world.

## Logistics Excellence

Enerpac's mission is to maintain service excellence in the ever-changing world of modern distribution. Providing our extensive range of products to our thousands of distributors worldwide demands a logistic expertise only a market leader can provide.



## A Tradition of Innovation

Enerpac has a long history of finding new solutions to better meet the challenges of the industries we serve. We were the first to develop a swing clamp with an internal rotation system. Our Collet-Lok® clamping products have provided our customers with both automation and security by combining hydraulic clamping actuation with an internal lock to mechanically retain the clamping force. The ZW-Class series of electric pumps are designed to run cool, be more energy efficient and easy to configure to your application. Our Auto-coupler connection system provides an automated connection to the fixture, perfect for robotic loaded applications. To support our production machining customers, Enerpac continues to identify new solutions for your most challenging applications.

# A Guide to Your New Enerpac Workholding Catalog

**The New Enerpac Workholding catalog;  
... helps you design more efficient workholding fixtures,  
... is a global resource of workholding solutions.**

**This catalog is set-up  
in two main sections:**

**1 Imperial hydraulic product data section**

All Enerpac hydraulic workholding products shown with imperial based specifications and dimensions.

**2 Yellow Pages section**

Your guide to safety, basic hydraulics and application suggestions.

**Selecting the right product  
for your application:**

- 1.** Select your main product category from the *main index* on page 3. This index shows page numbers of product offerings in the catalog.
- 2.** From here you go to the selected product *range overview*. For an example see pages 20 and 21 for the swing cylinders and work supports overview. On this page you will find the main groups with regard to functional and mounting style options.
- 3.** Proceed to pages 22 and 23 to narrow down your selection with regard to function, mounting style and clamping capacity. These application & selection pages offer a brief overview of an entire range of products within one group. Note that these pages have *yellow* columns on both sides of the spread.
- 4.** Once you have made your product selection you can proceed to the product data pages, 24 and onwards, of the specific product series of your choice. These pages have *gray* columns on both sides of the spread.

## Range overview

# Swing Clamps

**Swing Clamps**

ENERPAC's complete line of swing clamps provides maximum clamping force in the smallest possible package. With several mounting and operation styles available, Enerpac can design a swing clamp that you can't live without. Our unique patented clamp arm design is an industry exclusive, and makes Enerpac's swing cylinder the most versatile from ever before. Made to the highest quality standards, Enerpac swing clamps will provide maximum performance and trouble free operation.

**Technical support**

Refer to the "Yellow Pages" for:

- Safety instructions
- Basic hydraulic information
- Advanced hydraulic technology
- PMT (Pressure Monitoring System) monitoring
- Commodity charts and hydraulic symbols

Swing cylinder range overview **22 - 23**

Upper flange swing clamps	SU	24 - 25
Lower flange swing clamps	SL	26 - 27
Threaded body swing clamps	ST	28 - 29
Cartridge model swing clamps	SC	30 - 31
Clamp arms	CA	32 - 33
Pivoting T-arms	CAC CAPT	34 - 35
Upreach clamp arms	CAU	36 - 37
Swing clamps	SC	38
Swing clamps	ASC	39
Three-position swing clamps	WTR	40 - 41

## Application & selection pages

- Product or range photo including basic description of the products function.
- Listing of main product features and benefits.
- Selection criteria from a functional standpoint.
- Selection criteria from a mounting standpoint.
- Main selection chart, showing product function, mounting option and capacity.
- Product related options and accessories.

**Swing clamps Application & selection**

**Compact and full featured design**

- Compact design allows for limited or threaded part connection
- Large part mounting angle allows for better mounting surface
- Simple mounting preparation and easy installation - 3 or 4 mounting bolts
- Double or triple connection - threaded part or modified mount
- Symmetrical rectangular flange design enables clamping at all three sides of the cylinder

**Select your swing cylinder type:**

**Single setting**

- The rotation choice when there are no spring mechanisms, one side will rotate 90 degrees automatically.

**Double setting**

- Used when greater control is required during the anchoring cycle.
- When spring resistance are critical, low resistance for hydraulic pressure, resulting from long length or maximum clamping capacity being retained at the same time.

**Product selection**

Series	Model	Clamp range	Mounting	Capacity
SU	100	1.25 - 2.00	100	1000
	150	1.50 - 2.25	150	1500
	200	2.00 - 3.00	200	2000
	300	3.00 - 4.50	300	3000

**Swing clamps**

**Select your mounting method:**

**SU series, Upper flange mounting**

- Flexible design allows for modified or threaded part connection
- Flange face does not require high tolerances
- Easy installation with only 3 or 4 mounting bolts

**SL series, Lower flange mounting**

- Flexible design allows for modified or threaded part connection
- No flange face required
- Easy installation with only 3 or 4 mounting bolts

**ST series, Threaded body mounting**

- Minimal space required on flange
- Threaded part connection
- Can be threaded directly into the flange and secured as possible by means of standard flange nuts

**SC series, Cartridge mounting**

- Minimal space required on flange
- External plumbing not required
- Minimal clear positioning of end connections
- Cylinder can be completely recessed in flange

**Options**

- Flange: 475 - 700 lbs
- Stroke: 40 - 1.51 inch
- Pressure: 300 - 3000 psi
- Clamping pressure
- Valve de bridge products
- Sealant/anti-leak

**Important**

All swing clamps have working angle of 90°.

Other swing angles available upon request.

Contact Enerpac for info.

## Product data pages

- Application schematic including real life application example.
- Product selection.
- Detailed dimensional data.
- Product dimensional drawings.
- Installation specifications.

**Swing clamps - Upper flange model**

**Minimal mounting height**

- Flexible design allows for modified or threaded part connection
- Large part mounting angle allows for better mounting surface
- Simple mounting preparation and easy installation - 3 or 4 mounting bolts
- Double or triple connection - threaded part or modified mount
- Symmetrical rectangular flange design enables clamping at all three sides of the cylinder

**Product selection**

Series	Model	Clamp range	Mounting	Capacity
SU	100	1.25 - 2.00	100	1000
	150	1.50 - 2.25	150	1500
	200	2.00 - 3.00	200	2000
	300	3.00 - 4.50	300	3000

**Dimensions in inches**

Series	Model	Clamp range	Mounting	Capacity
SU	100	1.25 - 2.00	100	1000
	150	1.50 - 2.25	150	1500
	200	2.00 - 3.00	200	2000
	300	3.00 - 4.50	300	3000

**Swing clamps - Upper flange model**

**Installation dimensions in inches**

**Dimensions in inches**

Series	Model	Clamp range	Mounting	Capacity
SU	100	1.25 - 2.00	100	1000
	150	1.50 - 2.25	150	1500
	200	2.00 - 3.00	200	2000
	300	3.00 - 4.50	300	3000

**Options**

- Flange: 475 - 700 lbs
- Stroke: 40 - 1.51 inch
- Pressure: 300 - 3000 psi
- Clamping pressure
- Valve de bridge products
- Sealant/anti-leak

**Important**

All swing clamps have working angle of 90°.

Other swing angles available upon request.

Contact Enerpac for info.

# Collet-Lok®

Enerpac Collet-Lok® products combine the automation of hydraulic actuation with the security of an internal locking mechanism. After actuation and locking, these products maintain their clamping or supporting capacity without maintaining hydraulic pressure in the circuit. Available in Swing, Push, and Work Supports models, Enerpac Collet-Lok® products are also available in numerous special configurations and modifications.



## Swing Clamps

Enerpac Collet-Lok® Swing Clamps combine the rotational actuation and clamping force of a hydraulic Swing Clamp with an internal locking mechanism that maintains the applied clamping force without holding hydraulic pressure in the clamp. Ideal for use in

large-scale fixtures, they are available in 1000-, 2000-, and 8500 lb. models. Standard models are available in either Threaded Body or Lower Flange configurations. Available modifications include flange top manifold porting, longer strokes, non-rotational versions and special design bodies. Viton seals are standard.



## Work Supports

Enerpac Collet-Lok® Work Supports use internal spring force to lift the support rod into contact with the work piece and then maintain the support with an internal locking system. Cataloged in 2000-, 4500-, and 10,000 lb. capacities, these products are available in Threaded

Body (2000 and 4,000 lb. only) and Lower Flange models (2000, 4,000, and 10,000). Available modifications include longer strokes, flange top manifold porting, and special design bodies. Viton seals are standard.



## Push Cylinders

Enerpac Collet-Lok® Push Cylinders are designed for either clamping or supporting applications. The clamping or supporting force is maintained once the internal lock is engaged. Available in either 2500 or 5000 lb. capacities, these cylinders are available in both Threaded

Body or Lower Flange models. Available modifications include flange top manifold porting, longer strokes, and special design bodies. Viton seals are standard.

## Technical support




Refer to the “Yellow Pages” of this catalog for:

- Safety instructions
- Basic hydraulic information
- Advanced hydraulic technology
- FMS (Flexible Machining Systems) technology
- Conversion charts and hydraulic symbols

 197▶



# Products

	▼ series	▼ page	
<b>Collet-Lok® swing cylinder range overview</b>		<b>10-11</b>	
Collet-Lok® Swing clamps	WPFL, WPTL	12-15	
Collet-Lok® Work supports	WPFS, WPTS	16-17	
Collet-Lok® Push cylinders	WPFC, WPTC	18-19	

Shown: WPTR-100V and WPFR-100V



▶ Enerpac Collet-Lok® cylinders are designed to mechanically hold the workpiece after hydraulic pressure is removed. Clamping capacities range from 1000 lbs. to 8500 lbs.

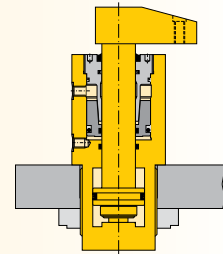
## Hydraulic actuation with mechanical lock

- Collet-Lok® technology combines hydraulic actuation for clamping or supporting with an internal locking collet
- Clamp bodies are available in either threaded mount or flange mount
- Flange mount units feature both tubing ports and bottom manifold ports
- Flange top manifold ports available as a special
- VITON seals are standard

## i Collet-Lok® Designs:

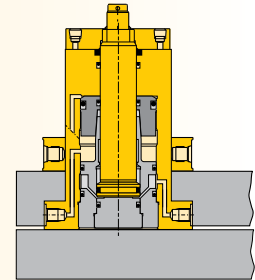
### Collet-Lok® Swing Clamps

- Available in 1000-, 2000-, and 8500 lb. models
- Available in Right Hand or Left Hand Swing and Straight (guided) models



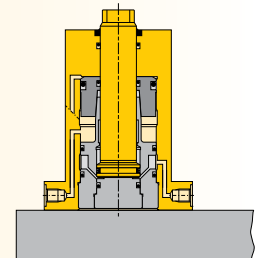
### Collet-Lok® Work Supports

- Available in 2,000-, 4,000- and 10,000 lb. models
- Spring advance design to maintain contact with the work piece



### Collet-Lok® Push Cylinders

- Available in 2,500- and 5,000 lb. models
- Designed for Push only
- Can be used as a heavy-duty Work Support



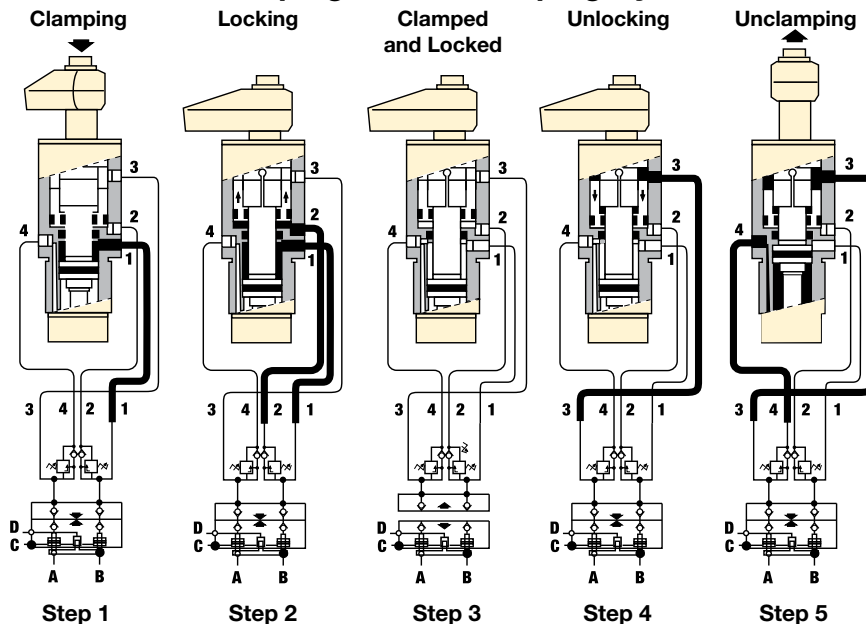
■ MPTL-100 and MPTR-100 Collet-Lok® Swing Clamps are used to securely clamp these exhaust manifolds.



## Why use Collet-Lok®?

Collet-Lok® technology from Enerpac combines hydraulic actuation with mechanical locking to provide the automation and control of hydraulics and the long term security of a mechanical lock. Available in Swing Clamps, Push Cylinders and Work Supports, Collet-Lok® is a unique solution that is well suited to today's demanding manufacturing environment.

## Collet-Lok® Clamping and Unclamping Cycle



WPTR-100 Collet-Lok® swing cylinder

- 1 = 90° Rotation + Clamp
- 2 = Lock
- 3 = Unlock
- 4 = Unclamp + 90° Rotation

WCA-62, WPA-62 Auto coupler

- A = Pressure line from pump to swing cylinder
- B = Pressure line from pump to swing cylinder
- C = Auto coupler advance
- D = Auto coupler retract

## How Does Collet-Lok® Work?

The ports on Collet products are conveniently labeled in the order that they are used during a clamping or unclamping cycle.

The typical Collet-Lok® circuit pairs the Clamp circuits with the Lock circuits by using a sequence valve to delay the Lock function until the clamping pressure is almost reached. When unclamping, the Unlock and Unclamp circuits are also paired with a sequence valve so the Lock is released before the clamp extends to Unclamp. An alternate approach to controlling these circuits is to use a PLC to operate individual valves for the Clamp/Unclamp and Lock/Unlock functions.

Because Collet-Lok® provides a mechanical lock to hold the clamping force onto the work piece, support components used in standard hydraulic clamping circuits such as pilot operated check valves and accumulators are not needed. In typical applications, the hydraulic circuit in a fixture with Collet-Lok® clamps is de-pressurized after the clamping cycle is completed. This allows for complete security during the machining cycle, or if the work pieces are pre-clamped and staged in a pallet pool for extended periods of time.

Force: 1000 - 8500 lbs

Stroke: .94 - 1.65 inch

Pressure: 1400 - 5000 psi

## Collet-Lok® Sequence:

### Step 1

2-passage Auto coupler connects external power source with pallet receiver and the Collet-Lok® cylinder is activated for hydraulic clamping.

### Step 2

After reaching maximum clamping pressure the sequence valve is opened and actuates the internal wedge hydraulically.

### Step 3

The wedge system secures the plunger position mechanically and the hydraulic pressure is taken off, then the auto coupler retracts. The work piece on the pallet is now securely clamped, without being connected to a power source.

### Step 4

After being in the machine the pallet returns to the loading and unloading position and the auto coupler is connected again to release the wedge.

### Step 5

The hydraulic plunger is now retracted and the pallet is free for unloading and loading.

## Options

Collet-Lok® swing clamps

8 ▶



Collet-Lok® work supports

16 ▶



Collet-Lok® push clamps

18 ▶



# Swing cylinders - Collet-Lok® design

Shown: WPTR-100V, WPFTR-100V

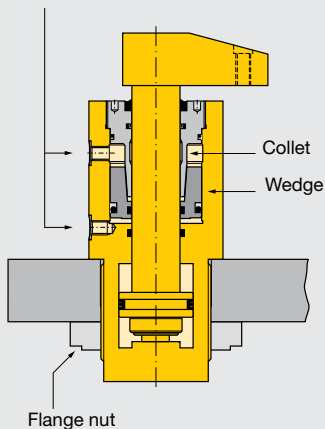
Collet-Lok® products



## WP series

Enerpac Collet-Lok® cylinders are designed to mechanically hold the workpiece after hydraulic pressure is removed. Clamping capacities range from 1000 lbs. to 8500 lbs.

SAE oil connection



Hydraulic pressure pushes the collet up a wedge, locking the plunger in the clamping position.



■ Lower flange Collet-Lok® swing cylinder mounted on a pallet.



## Ideal when live hydraulics are not available

- Double acting Collet-Lok® action allows fully automated operation
- Additional level of safety since live hydraulics are not required to maintain clamping force
- Collet-Lok® swing cylinders can be mounted by the flange or threaded into the fixture. Flanged models have manifold ports and tubing ports.
- Viton seals are standard

## Selection chart

Clamping force <sup>1)</sup> lbs	Stroke in		Left turning 	Right turning 90° 	Cylinder effective area in <sup>2</sup>		Oil capacity in <sup>3</sup>		Max. oil flow <sup>1)</sup> in <sup>3</sup> /min	Standard clamp arm Sold separately
	Clamp	Total			Clamp	Un-clamp	Clamp	Un-clamp		
<b>▼ Lower flange</b>										
<b>Model number</b>										
1000	.32	.95	<b>WPFL-50V</b>	<b>WPFTR-50V</b>	.25	.71	.24	.67	122	<b>CA-540</b>
2000	.47	1.11	<b>WPFL-100V</b>	<b>WPFTR-100V</b>	.50	1.11	.55	1.22	305	<b>CA-1050</b>
8500	.39	1.65	<b>WPFL-300V*</b>	<b>WPFTR-300V*</b>	2.05	3.45	3.40	5.70	600	<b>CA-3070</b>
<b>▼ Threaded body</b>										
<b>Model number</b>										
2000	.47	1.11	<b>WPTL-100V</b>	<b>WPTR-100V</b>	.50	1.11	.55	1.22	305	<b>CA-1050</b>
8500	.39	1.65	<b>WPTL-300V*</b>	<b>WPTR-300V*</b>	2.05	3.45	3.40	5.70	600	<b>CA-3070</b>

<sup>1)</sup> Using standard clamp arm. Clamp arms are sold separately (L14).

**Note:** - Call Enerpac for models with metric thread and BSPP port connections.  
- Minimum working pressure for Collet-Lok® system is 1400 psi.

\* This product is made to order. Please contact Enerpac for delivery information before specifying in your design.

## Collet-Lok® sequence

- Step 1**  
Pressurize port #1.  
Plunger turns 90° and clamps part.
- Step 2**  
Keep port #1 pressurized.  
Pressurize port #2.  
Plunger will be locked in clamped position.
- Step 3**  
Depressurize port #1 and #2.  
Uncouple cylinder from hydraulic power source.  
Part will be held in place.
- Step 4**  
Pressurize port #3.  
Plunger will be unlocked and the clamp force released.
- Step 5**  
Keep port #3 pressurized.  
Pressurize port #4.  
Plunger will extend and turn to its original position.

## Product dimensions in inches [ ]

Left turning models*	A	B	C	C1	D Ø	D1 Ø	F Ø	H1	H2	H3
<b>▼ Lower flange</b>										
<b>WPFL-50V</b>	7.92	6.97	6.74	0.98	2.28	3.35	0.75	0.39	0.49	-
<b>WPFL-100V</b>	8.77	7.67	6.48	0.98	2.68	3.94	0.88	0.39	0.49	-
<b>WPFL-300V</b>	12.67	11.02	10.82	0.98	3.53	5.19	1.38	0.43	0.49	-
<b>▼ Threaded body</b>										
<b>WPTL-100V</b>	8.39	7.28	4.78	3.56	1.875-16 UN	2.76	0.88	1.24	2.64	2.97
<b>WPTL-300V</b>	12.22	10.57	6.46	4.53	3.125-16 UN	3.66	1.38	1.5	3.62	3.96

**Note:** Dimensions shown with standard clamp arm.

\* For nonrotational model replace "L" with "N". Example: WPFN-100V

## Installation dimensions in inches

Clamping force <sup>1)</sup> lbs	Fixture hole Ø D3	Mounting thread J mm	Minimum depth J2
-------------------------------------	----------------------	-------------------------	---------------------

### ▼ Lower flange

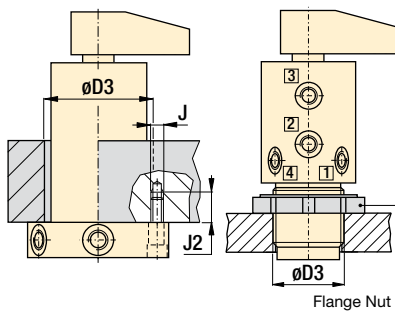
1000	2.301 ±.012	M6 x 1,00	.68
2000	2.701 ±.012	M8 x 1,25	.72
8500	3.565 ±.012	M10 x 1,50	.72

Clamping force <sup>1)</sup> lbs	Fixture hole Ø D3	Mounting flange Sold separately □ 87 ▶	Mounting nut Sold separately □ 86 ▶
-------------------------------------	----------------------	----------------------------------------------	-------------------------------------------

### ▼ Threaded body

2000	1.875-16 un	MF-481	FN-481
8500	3.125-16 un	MF-801	FN-801

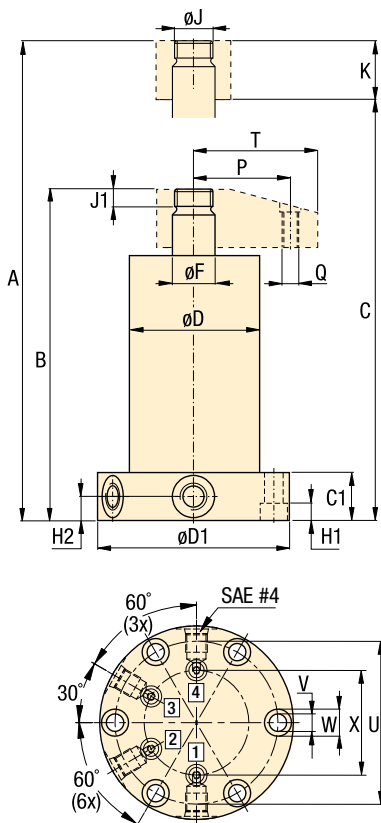
<sup>1)</sup> With standard clamp arm.



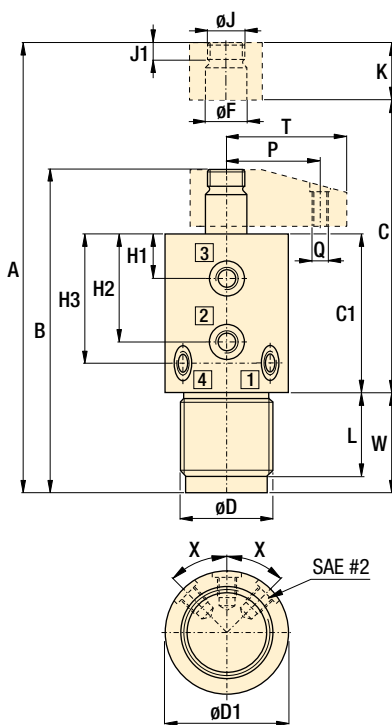
### Oil port functions

- 1) 90° Rotation and clamp
- 2) Locks system
- 3) Unlocks system
- 4) Unclamp and 90° rotation

### WPF models



### WPT models



X = 45° WPT-100 models

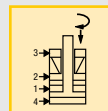
X = 30° WPT-300 models

Force: 1000 - 8500 lbs

Stroke: .94 - 1.65 inch

Pressure: 1400 - 5000 psi

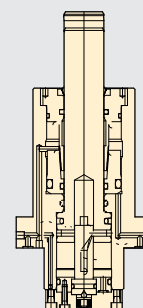
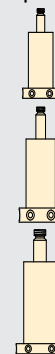
- E Cilindros giratorios
- F Vérins de bridage pivotants
- D Schwenkspannzylinder



### Custom Options Available

Intermediate capacities

Different flange locations



**FMS** Flexible Machining Systems  
See Yellow Pages (□ 224)

### Options

Clamp arms

□ 14 ▶



Collet-Lok® work supports

□ 16 ▶



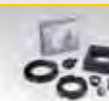
Sequence valves

□ 152 ▶



Accessories

□ 86 ▶



### Important

Minimum unlock pressure must be at least 1500 psi above lock pressure.

	J	J1	K	L	P	Q	T	U	V	W	X	Right turning models	
	Ø					Ø		Ø	Ø	Ø	Ø	lbs	
<b>Lower flange ▼</b>													
	.625-18 UNF	0.31	1.18	-	1.57	.313-24 UNF	2.13	2.76	0.35	0.55	1.89	5.1	WPFR-50V *
	.750-16 UNF	0.35	1.18	-	1.97	.375-24 UNF	2.52	3.31	0.35	0.55	2.13	7.7	WPFR-100V*
	1.250-12 UNF	0.39	1.85	-	2.76	.625-18 UNF	3.66	4.41	0.43	0.67	3.78	26.5	WPFR-300V*
<b>Threaded body ▼</b>													
	.750-16 UNF	0.35	1.18	1.63	1.97	.375-24 UNF	2.52	-	-	2.44	-	6.6	WPTR-100V*
	1.250-12 UNF	0.39	1.85	3.35	2.76	.625-18 UNF	3.66	-	-	3.92	-	24.2	WPTR-300V*

# Swing cylinders, CA Series *Dimensions & options*

Collet-Lok® products

**Force: 1000 - 8500 lbs**

**Stroke: 500 - 5000 psi**

- E** Brazos de amarre
- F** Bras de bridage
- D** Spannarme

## Options

### Gauges

190 ▶



### Flow control valves

155 ▶



### Sequence valves

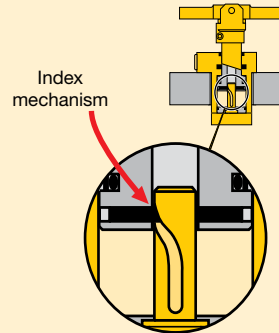
152 ▶



## ⚠ Important

### Do not exceed maximum oil flow.

If flow rates are exceeded, swing cylinder indexing mechanism may be permanently damaged.

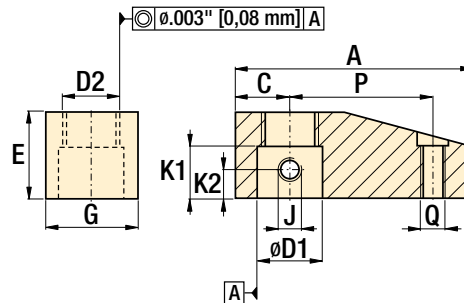


When designing custom clamp arms, the flow rates must be further reduced. This rating should be in proportion to the mass and the center of gravity of the clamp arm.

### Example:

*If the mass of the arm is twice that of the long arm, flow rates must be reduced by 50%.*

## CA models Standard clamp arms for Collet-Lok® swing clamps



## Product dimensions in inches [ ]

Clamp force lbs	Model number	A	C	D1 Ø	D2 UNF	E	G	J UNF	K1	K2	P	Q UNF	lbs
▼ Standard clamp arms for Collet-Lok® swing clamps													
1000	CA-540	2.94	.71	.749-.750	.625-18	1.18	1.26	.313-24	.75	.39	1.57	.313-24	1.2
2000	CA-1050	3.27	.75	.878-.879	.75-16	1.18	1.38	.313-24	.71	.39	1.97	.375-24	1.2
8500	CA-3070	5.04	1.38	1.377-1.378	1.25-12	1.85	2.32	.313-24	1.26	.67	2.76	.625-18	5.0

**i** Special configurations are available

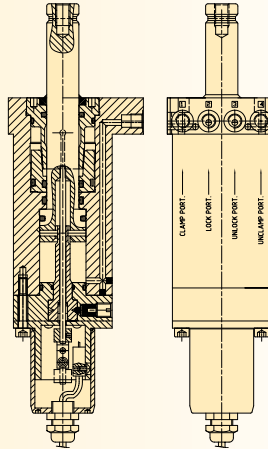
**Model: MPFL100PE001-S**

**Body style:** Upper flange

**Clamp capacity:** 2000 lbs (9 kN)

**Clamping stroke:** .71 in. (18 mm)

**Special feature:** Position sensing



## Special features for Swing Cylinders\*

Enerpac can design Collet-Lok® cylinders with special features to meet the needs of your production fixtures:

- Special mounting
- Special manifold port location
- Longer stroke
- Special rotation
- Internal clutch to protect rotation mechanism
- Viton seals
- Special rod end
- Position sensing

\*Special features also available for Collet-Lok® Push Cylinders and Work Supports.

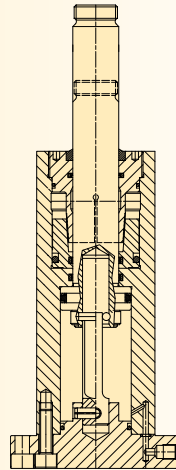
**Model: MPFN300VE002**

**Body style:** Lower flange

**Clamp capacity:** 8800 lbs (39 kN)

**Clamping stroke (straight):**  
2.25 in. (57,4 mm)

**Special feature:** Viton seals  
Long stroke



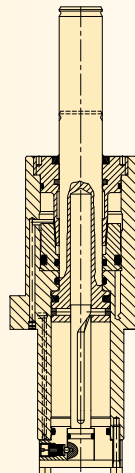
**Model: MPFL200VE100**

**Body style:** Mid-body flange

**Clamp capacity:** 3900 lbs (20 kN)

**Clamping stroke (left hand):**  
2.50 in. (63,5 mm)

**Special feature:** Viton seals  
Long stroke  
Mid-flange body



# Work supports - Collet-Lok® design

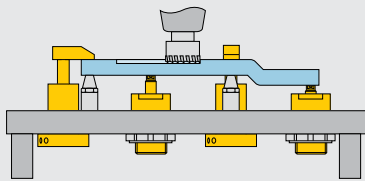
Shown: WPFS-100, WPTS-100

Collet-Lok® products



## WP series

Enerpac work supports provide either additional non-fixed location points to the clamps, or support to larger or thin section workpiece components, always in order to minimize workpiece deflection during machining. The Collet-Lok® design does not require hydraulic system pressure to maintain support position.



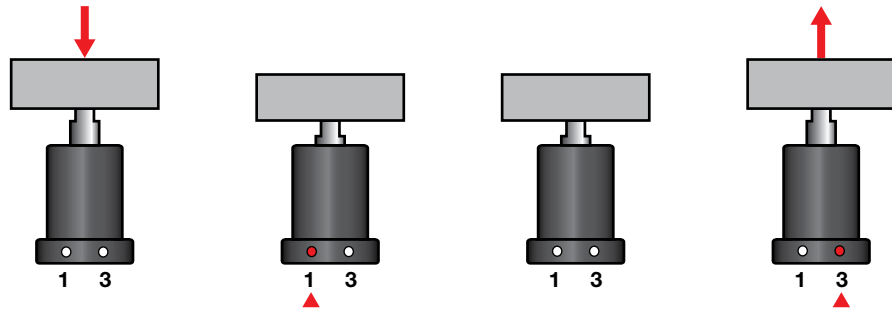
While pallet No. 1 is in the machine, a new work piece is loaded on to pallet No. 2.



## Hydraulically locked, mechanically maintained work support

- Collet-Lok® design allows the work support to maintain support position after the hydraulic pressure is removed
- Collet-Lok® maintains a higher level of safety, as it is not dependent on hydraulic supply pressure
- Low deflection: lowest deflection of any work support available
- Threaded or flanged body increases mounting flexibility
- Capacities up to 10,000 lbs available

## Collet-Lok® sequence



### Step 1

Install the workpiece on the support cylinder. The plunger position will adjust to the contour of the workpiece.

### Step 2

Pressurize oil port #1. The plunger will be locked in the supporting position.

### Step 3

Depressurize oil port #1. Cylinder can be uncoupled from hydraulics and still support the workpiece.

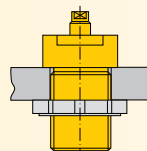
### Step 4

Pressurize oil port #3. The plunger will be unlocked. When the workpiece is removed, plunger will extend into its original position.

## Mounting style

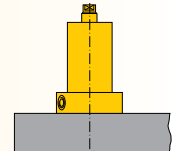
### WPT series, Threaded mount

Threaded body can be used with a threaded hole in fixture plate or a jam nut with a bored hole. Ports are located in top collar block.



### WPF series, Flange models

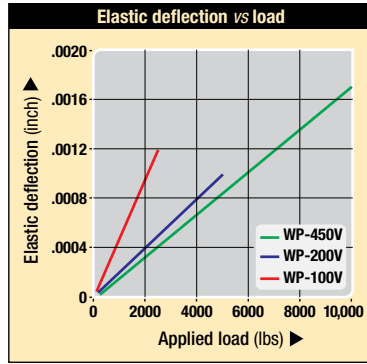
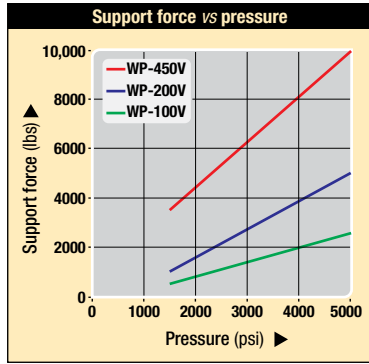
Mounts directly to fixture plate. Offers the flexibility of side ports or manifold ports on the underside of the flange.



## Product selection

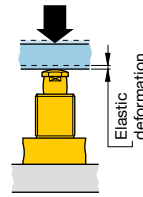
Max. support force	Support plunger stroke	Flange models	Threaded models	Operating pressure		Locking system displacement		Plunger contact spring force	Max. oil flow
				min.	max.	lock	unlock		
2000	0.39	WPFS-100V	-	1450	5000	0.24	0.24	4.50	30
4000	0.39	WPFS-200V	-	1450	5000	0.37	0.37	7.90	60
10,000	0.77	WPFS-450V	-	1450	5000	1.10	1.10	67.50	240
2000	0.39	-	WPTS-100V	1450	5000	0.24	0.24	3.37	30
4000	0.39	-	WPTS-200V	1450	5000	0.37	0.37	6.74	60





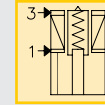
**Deflection chart:**

Elastic deformation of the work support resulting from the application of load.



- Force: 2000 - 4000 lbs
- Stroke: 0.39 - .77 inch
- Pressure: 1450 - 5000 psi

- E** Cilindros de soporte
- F** Vérin anti-vibreur
- D** Abstützylinder



**Options**

**Collet-Lok® swing cylinders**  

 12 ▶

**Auto couplers**  

 174 ▶

**Positive clamping cylinders**  

 80 ▶

**Sequence valves**  

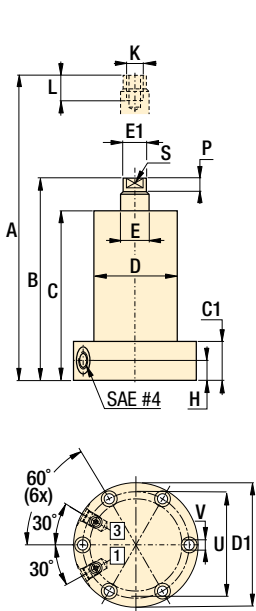
 152 ▶

**Important**

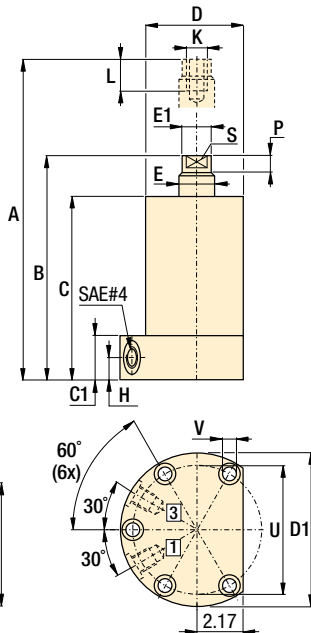
**WARNING!**  
 Support force and clamping force must be matched. Support force should be at least 150% of clamping force.

For proper application, clamp force, pressures and timing, consult Enerpac for support.

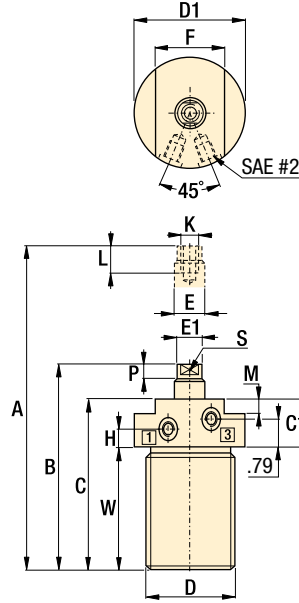
WPFS-100V, -200V



WPFS-450V



WPTS-100V, -200V



**Product dimensions** in inches [ ]

Model number	A	B	C	C1	D	D1	E	E1	F	H	K	L	M	P	S	U	V	W	X	lbs
					Ø	Ø	Ø	Ø			UNF					Ø	Ø		Ø	
<b>▼ Flange models</b>																				
WPFS-100V	4.88	4.49	4.17	0.98	Ø 2.99	4.33	0.62	0.55	-	0.49	.313-24	0.59	-	0.2	Ø.11*	3.7	0.35	-	3.21	8.8
WPFS-200V	4.96	4.56	4.17	0.98	Ø 3.62	5.12	0.98	0.91	-	0.49	.500-20	0.79	-	0.2	Ø.11*	4.41	0.35	-	3.82	13.2
WPFS-450V	7.61	6.84	6.34	0.98	Ø 5.12	6.49	1.97	1.89	-	0.49	.750-16	1.18	-	0.39	1.18**	5.79	0.43	-	4.92	35.2
<b>▼ Threaded models</b>																				
WPTS-100V	4.84	4.45	4.13	1.50	2.375-12	2.94	0.62	0.55	2.17	0.61	.313-24	0.59	0.79	0.20	Ø.11*	-	-	2.64	-	6.6
WPTS-200V	4.92	4.53	4.13	1.50	3.125-16	3.73	0.98	0.91	2.76	0.61	.500-20	0.79	0.79	0.26	Ø.11*	-	-	2.64	-	8.8

\* Spanner holes (x 2)  
 \*\* Wrench Flats

Collet-Lok® Products  
 Swing Clamps  
 Work Supports  
 Linear Cylinders  
 Power Sources  
 Valves  
 Pallet Components  
 System Components  
 Yellow Pages

# Push cylinders - Collet-Lok® design

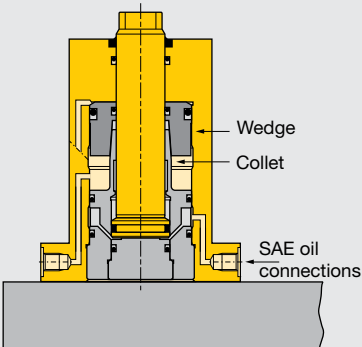
Shown: WPTC-110, WPFC-210



## WP series

Collet-Lok® positive locking push cylinders are designed to mechanically hold the workpiece after hydraulic pressure is removed.

Push capacities range from 2500 lbs. to 5000 lbs.



Hydraulic pressure pushes the collet up a wedge, locking the plunger in the clamping position.

Lower flange Collet-Lok® push cylinder used for positioning a motorcycle frame.

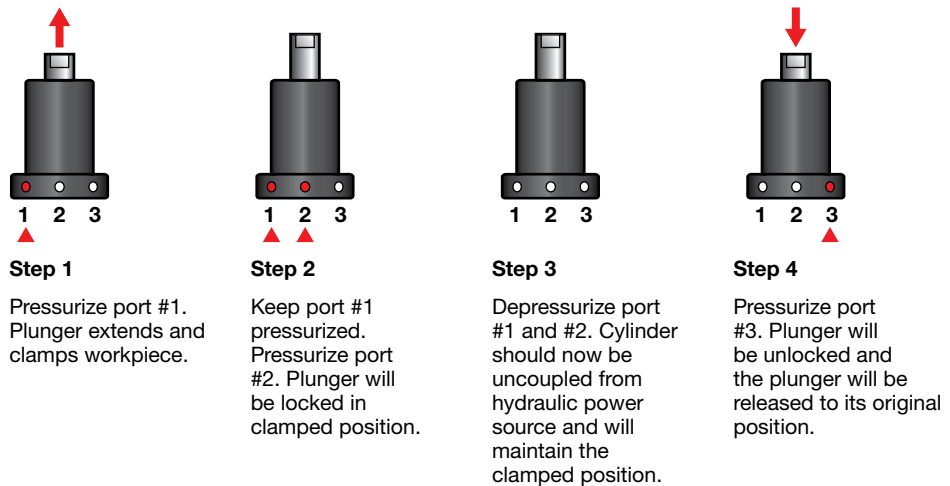


Ideal when live hydraulics are not available

...clamping is sustained mechanically so live hydraulics are not required during the machining cycle

- Double-acting Collet-Lok® action allows fully automated operation
- Additional level of safety since live hydraulics are not required
- Collet-Lok® push cylinders can either be mounted by the flange, or threaded into the fixture
- The Collet-Lok® design is an industry exclusive
- Capacities up to 8800 lbs. available on request

## Collet-Lok® sequence



## Product selection

Max. push force	Hydr. plunger stroke	Lower flange	Threaded body	Operating pressure		Hydraulic effective area		Oil capacity		Max. oil flow
				min.	max.	psi adv.	adv.	in <sup>2</sup> unlock	retr.	
2500	.60	WPTC-110V	WPTC-110V	725	5000	.50	.30	.37	.24	600
5000	.60	WPFC-210V	WPFC-210V	725	5000	.99	.61	.61	.37	600

Maximum cycle rate: 8 cycles/min.

Note: Call Enerpac to order models with metric thread and BSPP port connections.

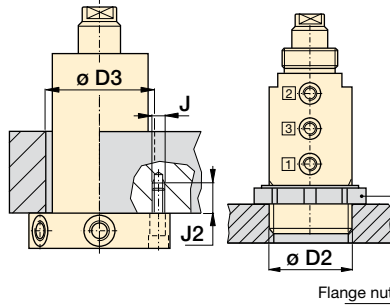
Capacities up to 8800 lbs. available on request.

## Dimensions in inches [ ]

Model number	A	B	C	C1	D	D1	D2	E	E1	F
						0		0	0	0
▼ Lower flange										
WPTC-110V	6.09	5.49	5.16	-	Ø 2.76	3.94	-	0.62	0.59	-
WPFC-210V	6.80	6.20	5.87	-	Ø 3.07	4.33	-	0.87	0.79	-
▼ Threaded body										
WPTC-110V	6.05	5.45	5.12	0.74	2.375-12 UN	2.52	1.500-12 UNF	0.62	0.59	1.81
WPTC-210V	6.76	6.16	5.83	0.71	2.750-16 UN	2.91	1.875-16 UN	0.87	0.79	2.17

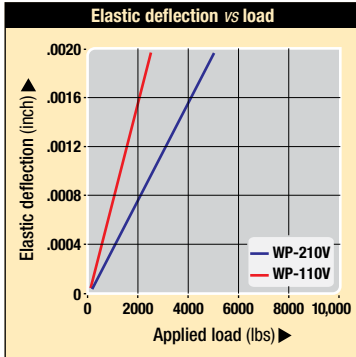
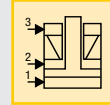
**Installation dimensions** in inches

Push force lbs	Fixture hole $\phi$ D3	Mounting thread J	Minimum depth J2
<b>▼ Lower flange</b>			
2500	2.79	M6	.68
5000	3.10	M8	.72
<b>▼ Threaded body</b>			
2500	2.375-12 UN	-	-
5000	2.750-16 UN	-	-

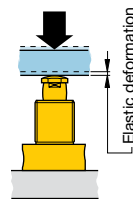


- Push force: 2500-5000 lbs**
- Stroke: .60 inch**
- Pressure: 725-5000 psi**

- E Cilindros de empuje**
- F Vérins pousseurs**
- D Gesicherter Druckzylinder**

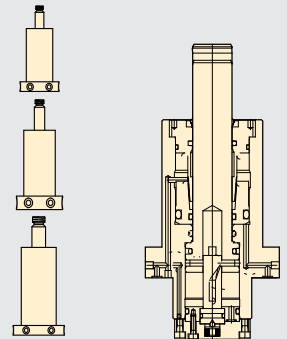


**Deflection chart:**  
Elastic deformation of the plunger resulting from the application of load.

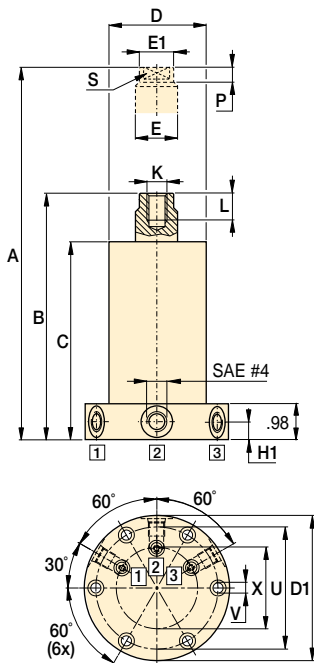


**Custom Options Available**

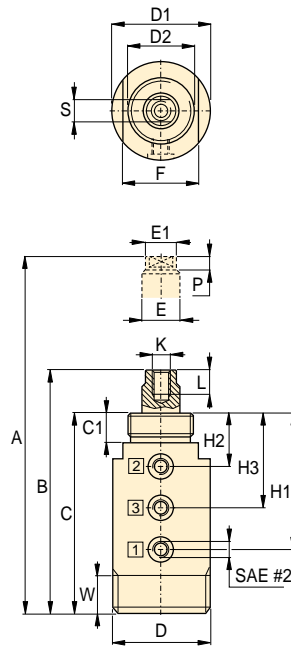
- Intermediate capacities**
- Different flange locations**



**WPFC**



**WPTC**



**Oil port functions**

- 1** Clamp
- 2** Lock
- 3** Unlock/Retract

H1	H2	H3	K	L	P	S*	U	V	W	X	lbs	Model number
<b>Lower flange ▼</b>												
0.49	-	-	.313-24 UNF	0.59	0.24	$\emptyset$ .11*	3.31	0.28	-	2.21	8.8	<b>WPFC-110V</b>
0.49	-	-	.375-24 UNF	0.79	0.2	$\emptyset$ .11*	3.7	0.35	-	2.76	11.0	<b>WPFC-210V</b>
<b>Threaded body ▼</b>												
3.78	1.30	2.56	.313-24 UNF	0.59	0.24	$\emptyset$ .11*	-	-	0.75	-	6.6	<b>WPTC-110V</b>
4.37	1.26	2.83	.375-24 UNF	0.79	0.20	$\emptyset$ .11*	-	-	0.79	-	7.5	<b>WPTC-210V</b>

\* Spanner holes (x 2)

**Options**

- Auto couplers**  
174 ▶
- Sequence valves**  
152 ▶
- Accessories**  
86 ▶
- Collet-Lok® swing cylinders**  
12 ▶

**Important**

For proper application, clamp force, pressures and timing, consult Enerpac for support.

# Swing Clamps

## Swing Clamps


Enerpac's complete line of swing clamps provides maximum clamping force in the smallest possible package. With several mounting and operation styles available, Enerpac can fit any clamping need you can think of. Our unique patented clamp arm design is an industry exclusive, and makes Enerpac's swing cylinder line more versatile than ever before. Made to the highest quality standards, Enerpac swing clamps will provide maximum performance and trouble free operation.



## Technical support




Refer to the "Yellow Pages" of this catalog for:

- Safety instructions
- Basic hydraulic information
- Advanced hydraulic technology
- FMS (Flexible Machining Systems) technology
- Conversion charts and hydraulic symbols

 197 ▶

▼ series

▼ page

<b>Swing cylinder range overview</b>		<b>22 - 23</b>	
Upper flange swing clamps	SU	24 - 25	
Lower flange swing clamps	SL	26 - 27	
Threaded body swing clamps	ST	28 - 29	
Cartridge model swing clamps	SC	30 - 31	
Clamp arms	CA	32 - 33	
Pivoting T-arms	CAC CAPT	34 - 35	
Upreach clamp arms	CAU	36 - 37	
Swing clamps	SC	38	
Swing clamps	ASC	39	
Three-position swing clamps	WTR	40 - 41	

# Swing clamps *Application & selection*

Shown: SCRD-122, STLD-21, SLRS-201

Collet-Lok®  
product line

Swing clamps

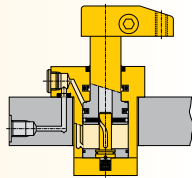


98-037

▶ Enerpac swing clamps allow unobstructed part fixturing and placement. The plunger rod and the attached clamp arm rotate 90 degrees in either a clockwise or counter-clockwise direction, then travel down an additional distance to clamp against the fixtured part. Upon release of clamping pressure, the clamp arm rotates back 90 degrees in the opposite direction to allow for part removal and new part placement.

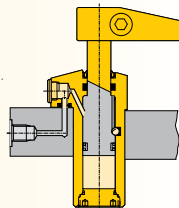
### Roller in groove

- Double index provides low height design to minimize fixture height
- Overload clutch allows clamp to disengage if needed to prevent damage due to improper part loading



### Ball in groove

- Rotation direction can be changed on-site to reduce spare inventory by 2/3 (67%)
- Ball and cam rotation ensures smooth accurate operation



■ *Swing clamps used in conjunction with work supports and other Enerpac components to positively hold the workpieces during machining operations.*

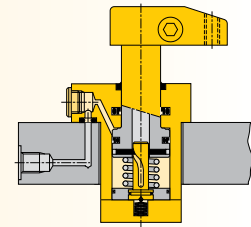
## Compact and full featured design

- Compact design allows for efficient fixture layout
- Variety of mounting styles to meet design needs
- Double and single-acting cylinders to suit a variety of hydraulic requirements
- Choice of porting styles to meet system and design requirements
- All cylinders are available as left and right turning models
- Large ball and cam design on 21, 51 and 121 models allows swing rotation to be changed easily
- Overload clutch mechanism on 92, 201, and 351 models prevents damage to cylinder from high flow rates or misapplication

## i Select your swing cylinder type:

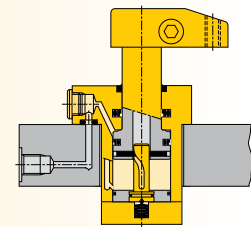
### Single acting

- The obvious choice when there are few system restrictions, and there are not many units retracting simultaneously
- Fewer valving requirements which results in a less complex circuit
- Innovative clamp arm design allows quick and secure arm positioning



### Double acting

- Used when greater control is required during the unclamp cycle
- When timing sequences are critical: less sensitive to system back pressures, resulting from long tube lengths or numerous components being retracted at the same time
- Innovative clamp arm design allows quick and secure arm positioning



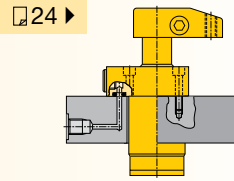
98-001

For Collet-Lok® positive locking swing clamps, see □ 12 ▶

## Select your mounting method:

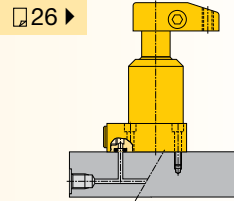
### SU series, Upper flange mounting

- Flexible design allows for manifold or threaded oil port connection
- Fixture hole does not require tight tolerances
- Easy installation with only 3 or 4 mounting bolts



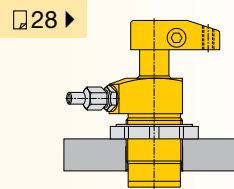
### SL series, Lower flange mounting

- Flexible design allows for manifold or threaded port connection
- No fixture hole required
- Easy installation with only 3 or 4 mounting bolts



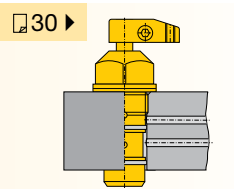
### ST series, Threaded body mounting

- Body thread for precise cylinder height positioning
- Threaded oil port connection
- Can be threaded directly into the fixture and secured in position by means of standard flange nuts



### SC series, Cartridge mounting

- Minimal space required on fixture
- External plumbing not required
- Allows close positioning of adjoining units
- Cylinder can be completely recessed in fixture



## Product selection

Clamping force <sup>1)</sup>	Stroke		Upper flange	Lower flange	Threaded body	Cartridge
	lbs	in clamping total				
<b>▼ Single acting</b>			Model number <sup>2)</sup>			
475	.32	.65	<b>SURS-21</b>	<b>SLRS-21</b>	<b>STRS-21</b>	<b>SCRS-22</b>
1100	.39	.89	<b>SURS-51</b>	<b>SLRS-51</b>	<b>STRS-51</b>	<b>SCRS-52</b>
1800	.47	.90	<b>SURS-92</b>	<b>SLRS-92</b>	<b>STRS-92</b>	-
2400	.50	1.10	<b>SURS-121</b>	<b>SLRS-121</b>	<b>STRS-121</b>	<b>SCRS-122</b>
3900	.55	1.16	<b>SURS-201</b>	<b>SLRS-201</b>	<b>STRS-201</b>	-
7450	.63	1.28	<b>SURS-351</b>	<b>SLRS-351</b>	<b>STRS-351</b>	-
<b>▼ Double acting</b>			Model number <sup>2)</sup>			
500	.32	.65	<b>SURD-21</b>	<b>SLRD-21</b>	<b>STRD-21</b>	<b>SCRD-22</b>
1250	.39	.89	<b>SURD-51</b>	<b>SLRD-51</b>	<b>STRD-51</b>	<b>SCRD-52</b>
2025	.47	.90	<b>SURD-92</b>	<b>SLRD-92</b>	<b>STRD-92</b>	-
2025	1.26	1.69	<b>SURDL-92*</b>	-	-	-
2600	.50	1.10	<b>SURD-121</b>	<b>SLRD-121</b>	<b>STRD-121</b>	<b>SCRD-122</b>
2600	1.25	1.85	<b>SURDL-121</b>	-	-	-
4200	.55	1.16	<b>SURD-201</b>	<b>SLRD-201</b>	<b>STRD-201</b>	-
7600	.63	1.28	<b>SURD-351</b>	<b>SLRD-351</b>	<b>STRD-351</b>	-
7600	1.25	1.91	<b>SURDL-351*</b>	-	-	-

<sup>1)</sup> With standard clamp arm. Clamp arms are sold separately (□ 32). Clamping forces for single-acting models are reduced in order to overcome return spring force. <sup>2)</sup> For left turning swing clamps replace the R in the model number for an L. **Note:** Call Enerpac to order models with metric thread and BSPP port connections.

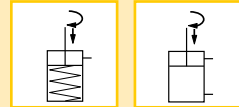
\* This product is made to order. Please contact Enerpac for delivery information before specifying in your design.

Force: 475 - 7600 lbs

Stroke: .65 - 1.91 inch

Pressure: 500 - 5000 psi

- E** Cilindros giratorios
- F** Vérins de bridage pivotants
- D** Schwenkspannzylinder



## Options

Available as both left and right turning

Left 90° Right

Clamp arms

□ 32 ▶

Work supports

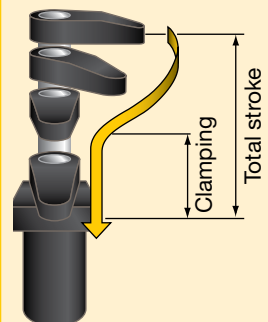
□ 43 ▶

Accessories

□ 86 ▶

## Important

Actual clamping may only take place when the cylinder has completed its 90° swing.



All swing clamps have swing angle repeatability of  $\pm 1^\circ$ .

Other swing angles available upon request.

Contact Enerpac for info.

# Swing clamps - Upper flange model

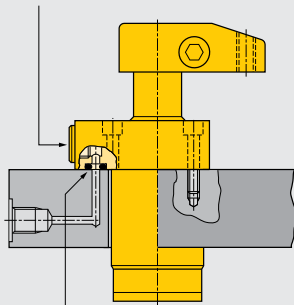
Shown: SURS-51, SURS-201



## SU series

The Enerpac upper flange swing clamps are designed for integrated manifold mounting solutions. Hydraulic connections are made through SAE or BSPP oil connection or the standard integrated O-ring ports.

SAE oil connection



Integrated O-ring port

■ Enerpac upper flange swing clamps integrated into a fully automated machining system.





## Minimal mounting height

...when space is at a premium

- Flexible design allows for manifold or threaded port connection
- Low profile mounting style allows body to be below mounting surface
- Simple mounting preparation and easy installation – 3 or 4 mounting bolts
- Double oil connection – threaded port or manifold mount
- Symmetrical rectangular flange design enables clamping at three sides of the cylinder
- 30, 45, and 60 degree swing angles available on request

## Product selection

Clamping force <sup>1)</sup>	Stroke		Left turning 90° 	Right turning 90° 	Cylinder effective area		Oil capacity		Max. oil flow <sup>1)</sup>	Standard clamp arm Sold separately □ 32 ▶
	lbs	Clamp			Total	in <sup>2</sup>	in <sup>3</sup>	Un-clamp		
<b>▼ Single acting</b>										
			<b>Model number<sup>2)</sup></b>							
475	.32	.65	<b>SULS-21</b>	<b>SURS-21</b>	.12	–	.08	–	12	<b>CAS-21</b>
1100	.39	.89	<b>SULS-51</b>	<b>SURS-51</b>	.28	–	.25	–	25	<b>CAS-51</b>
1800	.47	.90	<b>SULS-92</b>	<b>SURS-92</b>	.49	–	.42	–	60	<b>CAS-92</b>
2400	.50	1.10	<b>SULS-121</b>	<b>SURS-121</b>	.63	–	.70	–	100	<b>CAS-121</b>
3900	.55	1.16	<b>SULS-201</b>	<b>SURS-201</b>	1.10	–	1.22	–	140	<b>CAS-201</b>
7450	.63	1.28	<b>SULS-351</b>	<b>SURS-351</b>	1.92	–	2.27	–	240	<b>CAS-351</b>
<b>▼ Double acting</b>										
			<b>Model number<sup>2)</sup></b>							
500	.32	.65	<b>SULD-21</b>	<b>SURD-21</b>	.12	.24	.08	.16	12	<b>CAS-21</b>
1250	.39	.89	<b>SULD-51</b>	<b>SURD-51</b>	.28	.59	.25	.53	25	<b>CAS-51</b>
2025	.47	.90	<b>SULD-92</b>	<b>SURD-92</b>	.49	1.25	.42	1.08	60	<b>CAS-92</b>
2025	1.26	1.69	<b>SULDL-92*</b>	<b>SURDL-92*</b>	.49	1.25	.81	1.86	60	<b>CAS-92</b>
2600	.50	1.10	<b>SULD-121</b>	<b>SURD-121</b>	.63	1.23	.70	1.40	100	<b>CAS-121</b>
2600	1.25	1.85	<b>SULDL-121</b>	<b>SURDL-121</b>	.63	1.23	.97	2.30	100	<b>CAS-121</b>
4200	.55	1.16	<b>SULD-201</b>	<b>SURD-201</b>	1.10	2.35	1.22	2.60	140	<b>CAS-201</b>
7600	.63	1.28	<b>SULD-351</b>	<b>SURD-351</b>	1.92	3.68	2.27	4.35	240	<b>CAS-351</b>
7600	1.25	1.91	<b>SULDL-351*</b>	<b>SURDL-351*</b>	1.92	3.68	3.53	6.77	240	<b>CAS-351</b>

<sup>1)</sup> With standard clamp arm. Clamp arms are sold separately (□ 32). Clamping forces for single-acting models are reduced in order to overcome return spring force.

<sup>2)</sup> For models with straight plunger movement, replace L or R with S.

\* This product is made to order. Please contact Enerpac for delivery information before specifying in your design.

**Note:** Call Enerpac to order models with BSPP port connections.

## Dimensions in inches [ ]

Left turning models	A	B	C	C1	D	D1	D2	F	G	H	K	M
						Ø				Ø		
<b>▼ Single acting</b>												
<b>SULS-21</b>	4.41	2.32	1.05	1.69	1.10	1.86	1.77	0.39	SAE #2	0.43	0.63	–
<b>SULS-51</b>	5.33	2.73	1.08	1.97	1.37	2.13	2.25	0.63	SAE #4	0.38	0.76	–
<b>SULS-92</b>	5.68	3.00	1.11	2.02	1.88	2.76	2.13	0.98	G1/4"	0.51	0.99	0.59
<b>SULS-121</b>	6.75	3.37	1.08	2.18	1.87	2.62	2.88	0.87	SAE #4	0.39	1.20	–
<b>SULS-201</b>	6.57	3.47	1.12	2.28	2.46	3.35	2.76	1.26	SAE #4	0.51	1.19	0.91
<b>SULS-351</b>	7.45	3.96	1.11	2.39	3.02	3.94	3.50	1.50	SAE #4	0.51	1.58	1.08
<b>▼ Double acting</b>												
<b>SULD-21</b>	4.41	2.32	1.05	1.69	1.10	1.86	1.77	0.39	SAE #2	0.43	0.63	–
<b>SULD-51</b>	5.33	2.73	1.08	1.97	1.37	2.13	2.25	0.63	SAE #4	0.38	0.76	–
<b>SULD-92</b>	5.68	3.00	1.11	2.02	1.88	2.76	2.13	0.98	G1/4"	0.51	0.99	–
<b>SULDL-92*</b>	7.25	3.79	1.11	2.80	1.88	2.76	2.13	0.98	G1/4"	0.51	0.99	–
<b>SULD-121</b>	6.75	3.37	1.08	2.18	1.87	2.62	2.88	0.87	SAE #4	0.39	1.20	–
<b>SULDL-121</b>	9.00	4.12	1.08	2.93	1.87	2.62	2.88	0.87	SAE #4	0.39	1.20	–
<b>SULD-201</b>	6.57	3.47	1.12	2.28	2.46	3.35	2.76	1.26	SAE #4	0.51	1.19	–
<b>SULD-351</b>	7.45	3.96	1.11	2.39	3.02	3.94	3.50	1.50	SAE #4	0.51	1.58	–
<b>SULDL-351*</b>	8.70	4.59	1.11	3.01	3.02	3.94	3.50	1.50	SAE #4	0.51	1.58	–

**NOTE:** dimensions shown with standard clamp arm.

\* This product is made to order. Please contact Enerpac for delivery information before specifying in your design.

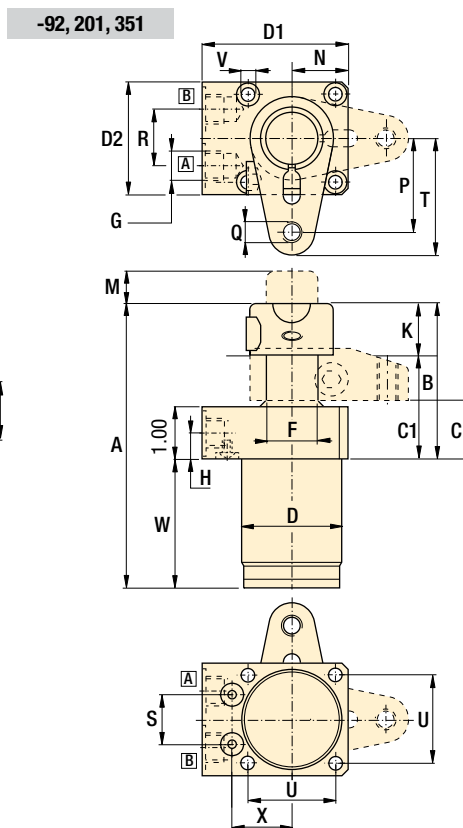
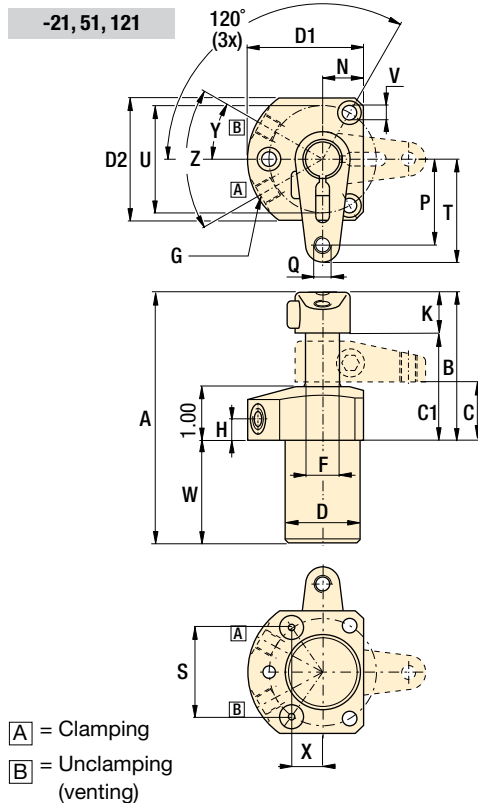
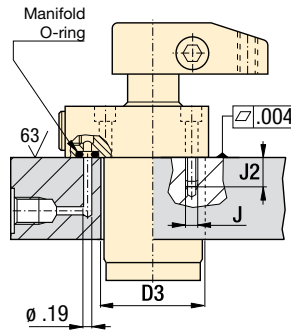


**Installation dimensions in inches**

Clamping force <sup>1)</sup> lbs	Fixture hole Ø D3	Mounting thread J UNF	Min. depth J2	Manifold O-ring <sup>2)</sup> ARP number or inside Ø x thickness
500	1.110	#10-32	.65	568-010
1250	1.380	.250-28	.65	568-011
2025	1.895	M6	.59	.17 x .139
2600	1.880	.312-24	.80	568-011
4200	2.475	.312-24	.67	.17 x .139
7600	3.035	.375-24	.74	.17 x .139

<sup>1)</sup> With standard clamp arm.  
<sup>2)</sup> Polyurethane, 92 Durometer

**Note:** Mounting bolts and O-rings included.

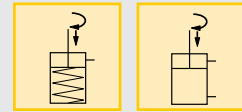


**A** = Clamping  
**B** = Unclamping (venting)

N	P	Q	R	S	T	U	V	W	X	Y	Z	Right turning models lbs
<b>Single acting ▼</b>												
0.61	0.97	.250-20 UNC	-	0.825	1.22	Ø1.58	0.225	2.09	0.714	30°	60°	1.0 <b>SURS-21</b>
0.75	1.58	.312-18 UNC	-	1.614	1.89	Ø1.97	0.268	2.6	0.565	30°	60°	2.5 <b>SURS-51</b>
1.04	1.78	M10 X 1,5	1.02	0.934	2.21	1.65	0.256	2.67	1.128	-	-	4.4 <b>SURS-92</b>
0.99	2.00	.375-16 UNC	-	2.048	2.44	Ø2.50	0.347	3.38	0.717	30°	60°	3.5 <b>SURS-121</b>
1.35	2.18	.500-13 UNC	1.02	1.145	2.77	2.17	0.335	3.11	1.382	-	-	7.7 <b>SURS-201</b>
1.71	2.68	.625-11 UNC	1.02	1.356	3.27	2.76	0.425	3.49	1.637	-	-	12.1 <b>SURS-351</b>
<b>Double acting ▼</b>												
0.61	0.97	.250-20 UNC	-	0.825	1.22	Ø1.58	0.225	2.09	0.714	30°	60°	1.0 <b>SURD-21</b>
0.75	1.58	.312-18 UNC	-	1.614	1.89	Ø1.97	0.268	2.6	0.565	30°	60°	2.5 <b>SURD-51</b>
1.04	1.78	M10 X 1,5	1.02	0.934	2.21	1.65	0.256	2.67	1.128	-	-	4.4 <b>SURD-92</b>
1.04	1.78	M10 X 1,5	1.02	0.934	2.21	1.65	0.256	2.67	1.128	-	-	5.7 <b>SURDL-92*</b>
0.99	2.00	.375-16 UNC	-	2.048	2.44	Ø2.50	0.347	3.38	0.717	30°	60°	3.5 <b>SURD-121</b>
0.99	2.00	.375-16 UNC	-	2.048	2.44	Ø2.50	0.347	3.38	0.717	30°	60°	4.0 <b>SURDL-121</b>
1.35	2.18	.500-13 UNC	1.02	1.145	2.77	2.17	0.335	3.11	1.382	-	-	7.7 <b>SURD-201</b>
1.71	2.68	.625-11 UNC	1.02	1.356	3.27	2.76	0.425	3.49	1.637	-	-	12.1 <b>SURD-351</b>
1.71	2.68	.625-11 UNC	1.02	1.356	3.27	2.76	0.425	3.49	1.637	-	-	15.1 <b>SURDL-351*</b>

**Force: 475 - 7600 lbs**  
**Stroke: .65 - 1.91 inch**  
**Pressure: 500 - 5000 psi**

- E** Cilindros giratorios
- F** Vérins de bridage pivotants
- D** Schwenkspannzylinder



**Options**

- Clamp arms** 32 ▶
- Work supports** 43 ▶
- Collet-Lok® swing cylinders** 12 ▶
- Accessories** 86 ▶

**Important**

30, 45, and 60 degree rotations are available upon request. Add -30, -45 or -60 to end of standard model number to order directly from Enerpac. To order rotation limiter separately, see page 58.

Custom cylinders including longer stroke lengths are available on request.

In case there is a risk of machining coolants and debris being inhaled via the breather vent, it is recommended to pipe this port to an area outside the fixture that is protected from machining coolants and debris.

Do not exceed maximum flow rates.

Swing clamps

Work supports

Linear cylinders

Power sources

Valves

Pallet components

System components

Yellow pages

# Swing clamps - Lower flange models

Shown: SLRD-51, SLRS-201



## No fixture hole required

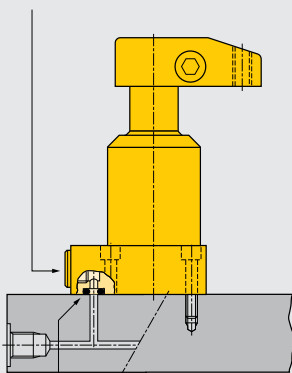
...cylinder can be bolted directly to fixture

- Flexible design allows for manifold or threaded port connection
- No fixture hole preparation required
- Easiest mounting preparation in the swing cylinder line
- Symmetrical rectangular flange design enables clamping at three sides of the cylinder
- Allows extra large parts to be clamped
- 30, 45 and 60 degree swing angles available on request

### SL series

Enerpac lower flange series swing clamps can be bolted to the fixture, allowing easy installation of the unit and does not require machined fixture holes. Hydraulic connections are made through SAE or BSPP oil connection or the standard integrated O-ring ports.

SAE oil connection



Integrated O-ring port

Lower flange swing clamps mounted to the face of the fixture.



## Product selection

Clamping force <sup>1)</sup>	Stroke		Left turning 90°	Right turning 90°	Cylinder effective area		Oil capacity		Max. oil flow <sup>1)</sup>	Standard clamp arm Sold separately 32 ▶
	lbs	Clamp			Total	in <sup>2</sup>	in <sup>3</sup>	Un-clamp		
<b>▼ Single acting</b>										
Model number <sup>2)</sup>										
475	.32	.65	<b>SLLS-21</b>	<b>SLRS-21</b>	.12	–	.08	–	12	<b>CAS-21</b>
1100	.39	.89	<b>SLLS-51</b>	<b>SLRS-51</b>	.28	–	.25	–	25	<b>CAS-51</b>
1800	.47	.90	<b>SLLS-92</b>	<b>SLRS-92</b>	.49	–	.42	–	60	<b>CAS-92</b>
2400	.50	1.10	<b>SLLS-121</b>	<b>SLRS-121</b>	.63	–	.70	–	100	<b>CAS-121</b>
3900	.55	1.16	<b>SLLS-201</b>	<b>SLRS-201</b>	1.10	–	1.22	–	140	<b>CAS-201</b>
7450	.63	1.28	<b>SLLS-351</b>	<b>SLRS-351</b>	1.92	–	2.27	–	240	<b>CAS-351</b>

<b>▼ Double acting</b>										
Model number <sup>2)</sup>										
500	.32	.65	<b>SLLD-21</b>	<b>SLRD-21</b>	.12	.24	.08	.15	12	<b>CAS-21</b>
1250	.39	.89	<b>SLLD-51</b>	<b>SLRD-51</b>	.28	.59	.25	.52	25	<b>CAS-51</b>
2025	.47	.90	<b>SLLD-92</b>	<b>SLRD-92</b>	.49	1.25	.42	1.08	60	<b>CAS-92</b>
2600	.50	1.10	<b>SLLD-121</b>	<b>SLRD-121</b>	.63	1.23	.70	1.40	100	<b>CAS-121</b>
4200	.55	1.16	<b>SLLD-201</b>	<b>SLRD-201</b>	1.10	2.35	1.22	2.60	140	<b>CAS-201</b>
7600	.63	1.28	<b>SLLD-351</b>	<b>SLRD-351</b>	1.92	3.68	2.27	4.35	240	<b>CAS-351</b>

<sup>1)</sup> With standard clamp arm. Clamp arms are sold separately (page 32). Clamping forces for single-acting models are reduced in order to overcome return spring force.»

<sup>2)</sup> For models with straight plunger movement, replace L or R with S.

**Note:** Call Enerpac to order models with BSPP port connections.

## Dimensions in inches [ ]

Left turning models	A	C	C1	D	D1	D2	F	G	H	K	M
					∅						
<b>▼ Single acting</b>											
<b>SLLS-21</b>	4.41	3.13	3.78	1.10	1.86	1.77	0.39	SAE #2	0.54	0.63	–
<b>SLLS-51</b>	5.33	3.68	4.57	1.37	2.13	2.25	0.63	SAE #4	0.55	0.76	–
<b>SLLS-92</b>	5.99	4.10	5.01	1.88	2.76	2.13	0.98	G1/4"	0.49	0.99	0.59
<b>SLLS-121</b>	6.75	4.46	5.56	1.87	2.62	2.88	0.87	SAE #4	0.61	1.2	–
<b>SLLS-201</b>	6.89	4.54	5.70	2.51	3.35	2.76	1.26	SAE #4	0.49	1.19	0.91
<b>SLLS-351</b>	7.77	4.91	6.19	3.14	3.94	3.50	1.50	SAE #4	0.49	1.58	1.08
<b>▼ Double acting</b>											
<b>SLLD-21</b>	4.41	3.13	3.78	1.10	1.86	1.77	0.39	SAE #2	0.54	0.63	–
<b>SLLD-51</b>	5.33	3.68	4.57	1.37	2.13	2.25	0.63	SAE #4	0.55	0.76	–
<b>SLLD-92</b>	5.99	4.10	5.01	1.88	2.76	2.13	0.98	G1/4"	0.49	0.99	–
<b>SLLD-121</b>	6.75	4.46	5.56	1.87	2.62	2.88	0.87	SAE #4	0.61	1.2	–
<b>SLLD-201</b>	6.89	4.54	5.70	2.51	3.35	2.76	1.26	SAE #4	0.49	1.19	–
<b>SLLD-351</b>	7.77	4.91	6.19	3.14	3.94	3.50	1.50	SAE #4	0.49	1.58	–

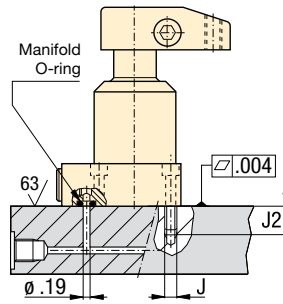
NOTE: dimensions shown with standard clamp arm.

**Installation dimensions** in inches

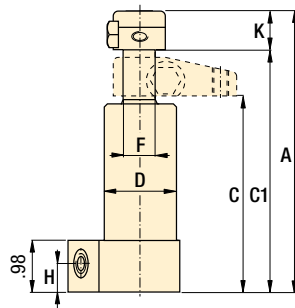
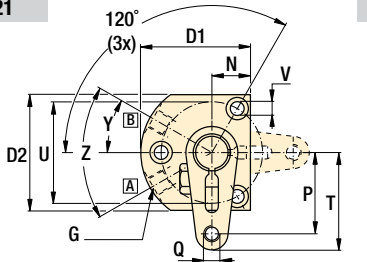
Clamping force <sup>1)</sup> lbs	Mounting thread J	Minimum thread depth J2	Manifold O-ring <sup>2)</sup> ARP number or inside Ø x thickness
500	#10-32	.65	568-010
1250	.250-28	.65	568-011
2025	M6	.59	.17 x .139
2600	.312-24	.80	568-011
4200	.312-24	.67	.17 x .139
7600	.375-24	.74	.17 x .139

<sup>1)</sup> With standard clamp arm.  
<sup>2)</sup> Polyurethane, 92 Durometer

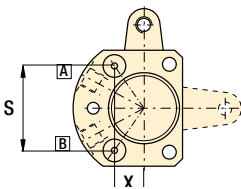
**Note:** Mounting bolts and O-rings included.



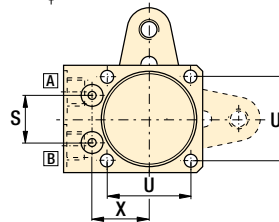
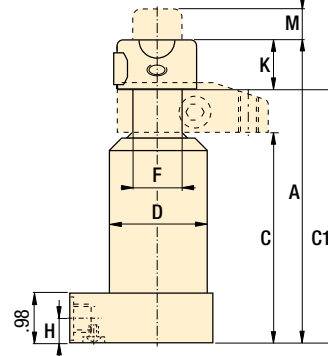
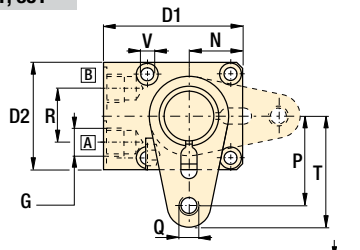
**-21, 51, 121**



**A** = Clamping  
**B** = Unclamping (venting)

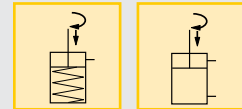


**-92, 201, 351**



- Force:** 475 - 7600 lbs
- Stroke:** .65 - 1.28 inch
- Pressure:** 500 - 5000 psi

- E** Cilindros giratorios
- F** Vérins de bridage pivotants
- D** Schwenkspannzylinder



**Options**

- Clamp arms** 32 ▶
- Work supports** 43 ▶
- Collet-Lok® swing cylinders** 12 ▶
- Accessories** 86 ▶

**Important**

30, 45, and 60 degree rotations are available upon request. Add -30, -45 or -60 to end of standard model number to order directly from Enerpac. To order rotation limiter separately, see page 32.

Custom cylinders including longer stroke lengths are available on request.

In case there is a risk of machining coolants and debris being inhaled via the breather vent, it is recommended to pipe this port to an area outside the fixture that is protected from machining coolants and debris.

Do not exceed maximum flow rates.

	N	P	Q	R	S	T	U	V	X	Y	Z	Right turning models
			UN				ø					lbs
												Single acting ▼
	0.61	0.97	.250-20 UNC	-	0.825	1.22	1.58	0.23	0.714	30°	60°	1.0 <b>SLRS-21</b>
	0.75	1.58	.312-18 UNC	-	1.614	1.89	1.97	0.27	0.565	30°	60°	2.5 <b>SLRS-51</b>
	1.04	1.78	M10 x 1,5	1.02	0.934	2.21	1.65	0.26	1.128	-	-	4.4 <b>SLRS-92</b>
	0.99	2.03	.375-16 UNC	-	2.048	2.44	2.5	0.35	0.717	30°	60°	3.5 <b>SLRS-121</b>
	1.35	2.18	.500-13 UNC	1.02	1.145	2.77	2.17	0.33	1.382	-	-	7.7 <b>SLRS-201</b>
	1.71	2.68	.625-11 UNC	1.02	1.356	3.27	2.76	0.43	1.637	-	-	12.1 <b>SLRS-351</b>
												Double acting ▼
	0.61	0.97	.250-20 UNC	-	0.825	1.22	1.58	0.23	0.714	30°	60°	1.0 <b>SLRD-21</b>
	0.75	1.58	.312-18 UNC	-	1.614	1.89	1.97	0.27	0.565	30°	60°	2.5 <b>SLRD-51</b>
	1.04	1.78	M10 x 1,5	1.02	0.934	2.21	1.65	0.26	1.128	-	-	4.4 <b>SLRD-92</b>
	0.99	2.03	.375-16 UNC	-	2.048	2.44	2.5	0.35	0.717	30°	60°	3.5 <b>SLRD-121</b>
	1.35	2.18	.500-13 UNC	1.02	1.145	2.77	2.17	0.33	1.382	-	-	7.7 <b>SLRD-201</b>
	1.71	2.68	.625-11 UNC	1.02	1.356	3.27	2.76	0.43	1.637	-	-	12.1 <b>SLRD-351</b>

Swing clamps

Work supports

Linear cylinders

Power sources

Valves

Pallet components

System components

Yellow pages

# Swing clamps - Threaded body models

Shown: STRD-51, STRD-201

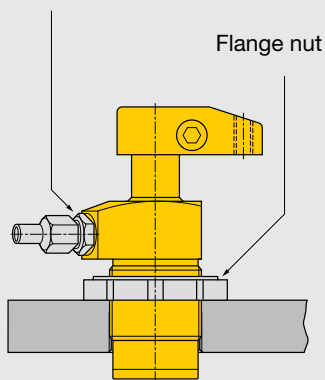


## ST series

Enerpac threaded body swing clamps are threaded directly into the fixture.

The cylinder height is adjusted to the appropriate height, and then locked in place using a jam nut (□32).

SAE oil connection



Threaded body swing clamps allow the clamp to be buried in the fixture to minimize the required area, while the height remains adjustable.



## Cylinders can be threaded directly into fixture

...can be secured at any height

- Body thread for precise cylinder height positioning
- Threaded port connection
- Easy installation and removal
- Greatest flexibility in fixture design
- 30, 45 and 60 degree swing angles available on request

## Product selection

Clamping force <sup>1)</sup>	Stroke		Left turning 90°	Right turning 90°	Cylinder effective area		Oil capacity		Max. oil flow <sup>1)</sup>	Standard clamp arm Sold separately □32 ▶
	lbs	Clamp			Total	in <sup>2</sup>	in <sup>3</sup>	Un-clamp		
<b>▼ Single acting</b>										
Model number <sup>2)</sup>										
475	.32	.65	<b>STLS-21</b>	<b>STRS-21</b>	.12	–	.08	–	12	<b>CAS-21</b>
1100	.39	.89	<b>STLS-51</b>	<b>STRS-51</b>	.28	–	.25	–	25	<b>CAS-51</b>
1800	.47	.90	<b>STLS-92</b>	<b>STRS-92</b>	.49	–	.42	–	60	<b>CAS-92</b>
2400	.50	1.09	<b>STLS-121</b>	<b>STRS-121</b>	.63	–	.70	–	100	<b>CAS-121</b>
3900	.55	1.16	<b>STLS-201</b>	<b>STRS-201</b>	1.10	–	1.22	–	140	<b>CAS-201</b>
7450	.63	1.28	<b>STLS-351</b>	<b>STRS-351</b>	1.92	–	2.27	–	240	<b>CAS-351</b>
<b>▼ Double acting</b>										
Model number <sup>2)</sup>										
500	.32	.65	<b>STLD-21</b>	<b>STRD-21</b>	.12	.24	.08	.15	12	<b>CAS-21</b>
1250	.39	.89	<b>STLD-51</b>	<b>STRD-51</b>	.28	.59	.25	.52	25	<b>CAS-51</b>
2025	.47	.90	<b>STLD-92</b>	<b>STRD-92</b>	.49	1.25	.42	1.08	60	<b>CAS-92</b>
2600	.50	1.09	<b>STLD-121</b>	<b>STRD-121</b>	.63	1.23	.70	1.40	100	<b>CAS-121</b>
4200	.55	1.16	<b>STLD-201</b>	<b>STRD-201</b>	1.10	2.35	1.22	2.60	140	<b>CAS-201</b>
7600	.63	1.28	<b>STLD-351</b>	<b>STRD-351</b>	1.92	3.68	2.27	4.35	240	<b>CAS-351</b>

<sup>1)</sup> With standard clamp arm. Clamp arms are sold separately (□32). Clamping forces for single-acting models are reduced in order to overcome return spring force.

<sup>2)</sup> For models with straight plunger movement, replace L or R with S.



**Note:** Call Enerpac to order models with BSPP port connections.

## Dimensions in inches [ ]

Left turning models	A	B	C	C1	C2	D	D1	D2	F	G	H	J1
							∅					
<b>▼ Single acting</b>												
<b>STLS-21</b>	4.41	2.32	1.04	1.69	0.98	1.125-16 UN	1.54	1.29	0.39	SAE#2	0.39	2.09
<b>STLS-51</b>	5.33	2.73	1.08	1.97	0.98	1.375-18 UNEF	1.88	1.49	0.63	SAE#4	0.38	2.60
<b>STLS-92</b>	5.68	3.21	1.32	2.22	1.19	M48 X 1,5	2.47	1.90	0.98	G1/4"	0.51	1.70
<b>STLS-121</b>	6.75	3.37	1.09	2.18	1.00	1.875-16 UN	2.38	2.00	0.87	SAE#4	0.38	3.38
<b>STLS-201</b>	6.57	3.74	1.40	2.56	1.26	2.500-16 UN	2.99	2.56	1.26	SAE#4	0.52	2.06
<b>STLS-351</b>	7.45	4.24	1.38	2.66	1.26	3.125-16 UN	3.48	3.15	1.50	SAE#4	0.51	2.45
<b>▼ Double acting</b>												
<b>STLD-21</b>	4.41	2.32	1.04	1.69	0.98	1.125-16 UN	1.54	1.29	0.39	SAE#2	0.39	2.09
<b>STLD-51</b>	5.33	2.73	1.08	1.97	0.98	1.375-18 UNEF	1.88	1.49	0.63	SAE#4	0.38	2.60
<b>STLD-92</b>	5.68	3.21	1.32	2.22	1.19	M48 X 1,5	2.47	1.90	0.98	G1/4"	0.51	1.70
<b>STLD-121</b>	6.75	3.37	1.09	2.18	1.00	1.875-16 UN	2.38	2.00	0.87	SAE#4	0.38	3.38
<b>STLD-201</b>	6.57	3.74	1.40	2.56	1.26	2.500-16 UN	2.99	2.56	1.26	SAE#4	0.52	2.06
<b>STLD-351</b>	7.45	4.24	1.38	2.66	1.26	3.125-16 UN	3.48	3.15	1.50	SAE#4	0.51	2.45

NOTE: dimensions shown with standard clamp arm.

**Accessory Chart**

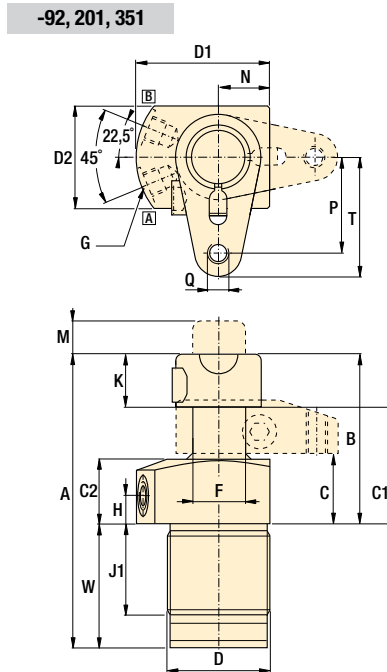
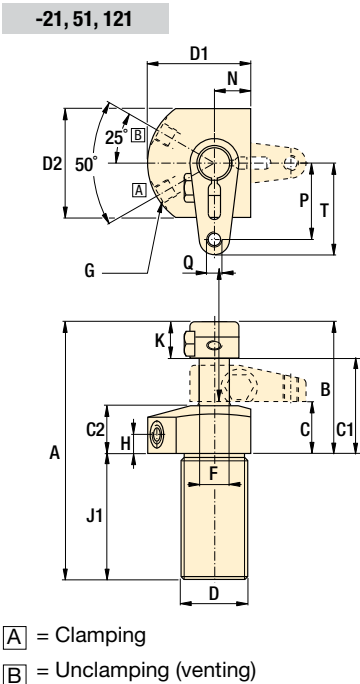
Model Nos.		Mounting flange	Flange nut
Left turning	Right turning		
		Sold Separately ☐ 87 ▶	Sold Separately ☐ 86 ▶


▼ **Single acting**

<b>STLS-21</b>	<b>STRS-21</b>	—	MF-281	FN-281
<b>STLS-51</b>	<b>STRS-51</b>	AW-5	MF-351	FN-351
<b>STLS-92</b>	<b>STRS-92</b>	—	MF-482	FN-482
<b>STLS-121</b>	<b>STRS-121</b>	AW-89	MF-481	FN-481
<b>STLS-201</b>	<b>STRS-201</b>	AW-19	MF-651	FN-651
<b>STLS-351</b>	<b>STRS-351</b>	AW-90	MF-801	FN-801

▼ **Double acting**

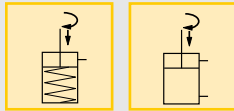
<b>STLD-21</b>	<b>STRD-21</b>	—	MF-281	FN-281
<b>STLD-51</b>	<b>STRD-51</b>	AW-5	MF-351	FN-351
<b>STLD-92</b>	<b>STRD-92</b>	—	MF-482	FN-482
<b>STLD-121</b>	<b>STRD-121</b>	AW-89	MF-481	FN-481
<b>STLD-201</b>	<b>STRD-201</b>	AW-19	MF-651	FN-651
<b>STLD-351</b>	<b>STRD-351</b>	AW-90	MF-801	FN-801




	K	M	N	P	Q	T	W	Y	Z		Right turning models
<b>Single acting ▼</b>											
	0.63	-	0.60	0.97	.250-20 UNC	1.22	-	25°	50°	1.1	<b>STRS-21</b>
	0.76	-	0.75	1.58	.312-18 UNC	1.89	-	25°	50°	2.5	<b>STRS-51</b>
	0.99	0.59	0.95	1.78	M10 x 1,5	2.21	2.47	22.5°	45°	4.4	<b>STRS-92</b>
	1.20	-	1.00	2.03	.375-16 UNC	2.44	-	25°	50°	3.5	<b>STRS-121</b>
	1.19	0.91	1.28	2.18	.500-13 UNC	2.77	2.83	22.5°	45°	7.1	<b>STRS-201</b>
	1.58	1.08	1.57	2.68	.625-11 UNC	3.27	3.22	22.5°	45°	12.1	<b>STRS-351</b>
<b>Double acting ▼</b>											
	0.63	-	0.60	0.97	.250-20 UNC	1.22	-	25°	50°	1.1	<b>STRD-21</b>
	0.76	-	0.75	1.58	.312-18 UNC	1.89	-	25°	50°	2.5	<b>STRD-51</b>
	0.99	-	0.95	1.78	M10 x 1,5	2.21	2.47	22.5°	45°	4.4	<b>STRD-92</b>
	1.20	-	1.00	2.03	.375-16 UNC	2.44	-	25°	50°	3.5	<b>STRD-121</b>
	1.19	-	1.28	2.18	.500-13 UNC	2.77	2.83	22.5°	45°	7.7	<b>STRD-201</b>
	1.58	-	1.57	2.68	.625-11 UNC	3.27	3.21	22.5°	45°	12.1	<b>STRD-351</b>


<b>Force: 475- 7600 lbs</b>
<b>Stroke: .65 - 1.28 inch</b>
<b>Pressure: 500 - 5000 psi</b>

- E** Cilindros giratorios
- F** Vérins de bridage pivotants
- D** Schwenkspannzylinder



**Options**

**Clamp arms**  
☐ 32 ▶ 

**Work supports**  
☐ 43 ▶ 

**Collet-Lok® swing cylinders**  
☐ 12 ▶ 

**Accessories**  
☐ 86 ▶ 

**Important**

30, 45, and 60 degree rotations are available upon request. Add -30, -45 or -60 to end of standard model number to order directly from Enerpac. To order rotation limiter separately, see page 32.

Custom cylinders including longer stroke lengths are available on request.

In case there is a risk of machining coolants and debris being inhaled via the breather vent, it is recommended to pipe this port to an area outside the fixture that is protected from machining coolants and debris.

Do not exceed maximum flow rates.

Swing clamps

Work supports

Linear cylinders

Power sources

Valves

Pallet components

System components

Yellow pages

# Swing clamps - Cartridge models

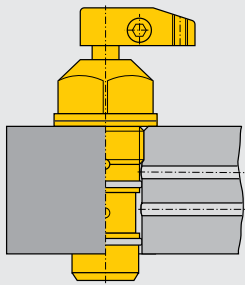
Shown: SCRD-122, SCRD-52



## SC series

Enerpac cartridge swing clamps are designed for integrated manifold mounting. This eliminates the need for fittings and tubing on the fixture.

Cartridge swing clamps simplify mounting and optimize clamping effectiveness.



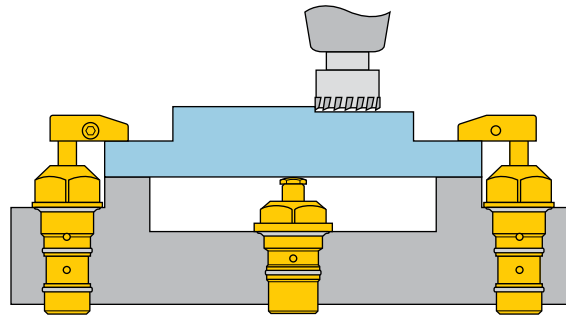
Hydraulic fixture with components on two faces for more efficient production.



## Eliminates the need for tubing and fittings

- Minimal space required on fixture
- Can be completely recessed in fixture
- External plumbing not required
- Allows close positioning of adjoining units
- 30, 45 and 60 degree swing angles available on request

**i** Enerpac compact design cartridge model swing clamps used in conjunction with a cartridge model work support in a typical clamping application.



## Product selection

Clamping force <sup>1)</sup>	Stroke		Left turning	Right turning	Cylinder effective area		Oil capacity		Max. oil flow <sup>1)</sup>	Standard clamp arm Sold separately □ 32 ▶
	lbs	in			in <sup>2</sup>	in <sup>3</sup>	in <sup>3</sup> /min			
▼ Single acting										
			Model number <sup>2)</sup>							
475	.32	.66			.12	-	.08	-	12	CAS-21
1100	.39	.89			.28	-	.25	-	25	CAS-51
2400	.50	1.09			.63	-	.70	-	100	CAS-121
▼ Double acting										
			Model number <sup>2)</sup>							
500	.32	.66			.12	.24	.08	.15	12	CAS-21
1250	.39	.89			.28	.59	.25	.52	25	CAS-51
2600	.50	1.09			.63	1.23	.70	1.40	100	CAS-121

<sup>1)</sup> With standard clamp arm. Clamp arms are sold separately (□32). Clamping forces for single-acting models are reduced in order to overcome return spring force.

<sup>2)</sup> For models with straight plunger movement, replace L or R with S.

## Dimensions in inches [ ]

Left turning models	A	B	C	C1	C2	D1	D2	E	F
						Ø	Ø	hexagon	
▼ Single acting									
SCLS-22	4.41	2.26	0.98	1.63	0.94	1.51	1.00	1.37	0.39
SCLS-52	5.33	3.14	1.49	2.39	1.39	2.23	1.37	1.99	0.63
SCLS-122	6.75	3.8	1.52	2.61	1.43	2.99	2.25	2.74	0.87
▼ Double acting									
SCLD-22	4.41	2.26	0.98	1.63	0.94	1.51	1.00	1.37	0.39
SCLD-52	5.33	3.14	1.49	2.39	1.39	2.23	1.37	1.99	0.63
SCLD-122	6.75	3.80	1.52	2.61	1.43	2.99	2.25	2.74	0.87

NOTE: dimensions shown with standard clamp arm.



# Clamp arms for swing clamps

Shown: CAS-121, CAL-122

Collet-Lok® product line

Swing clamps



## Patented Design

- Easy and precise location of the clamp arm in any position
- Arm can be easily installed and fastened while the cylinder is mounted in the fixture to allow exact arm positioning
- Vise not required for fastening arms

## Pressure vs clamping force

The use of different length clamp arms requires reduction in applied pressure and resulting clamp force. The charts below show this relationship.

**Enerpac's patented clamp arm design attaches to the hydraulic swing cylinder, allowing parts to be clamped at various distances from the hydraulic cylinder. Clamp arms are available in a variety of lengths, or you can use custom machining dimensions to create your own clamp arm configuration.**

Ordering rotation limiting spacers

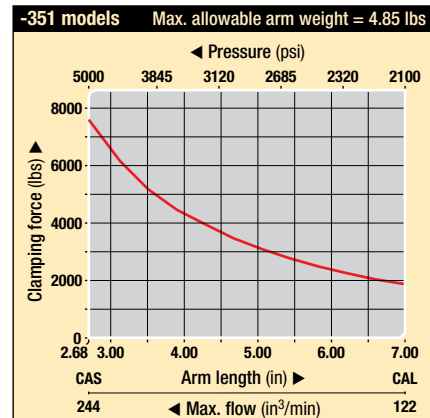
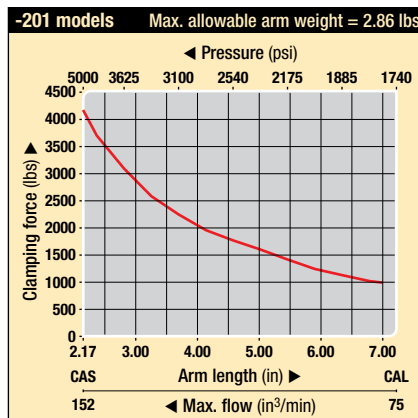
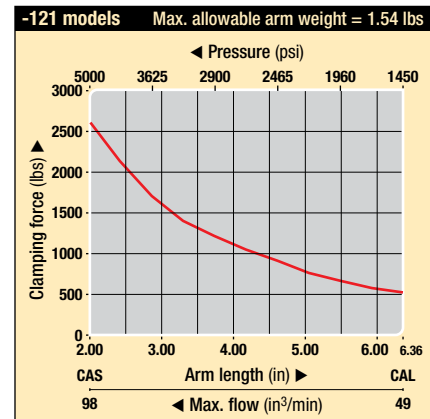
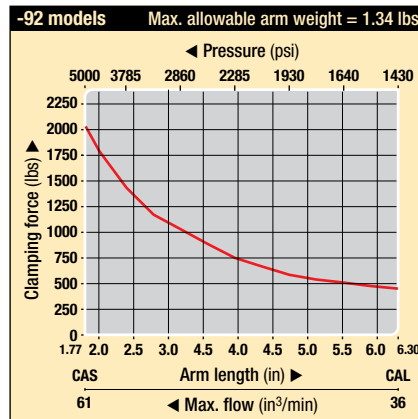
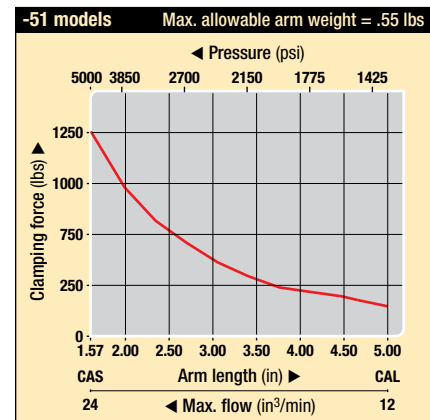
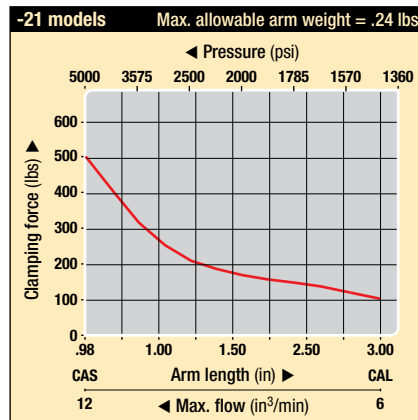
### BUILD YOUR PART NUMBER:

SP	186
Clamp force	Angle
02 = 500 lbs	30
05 = 1250 lbs	45
09 = 2025 lbs	60
12 = 2600 lbs	
20 = 4200 lbs	
35 = 7600 lbs	

### Example:

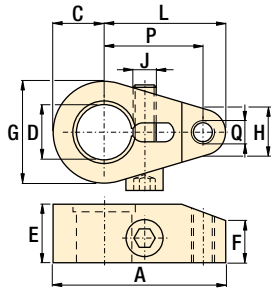
SP-12 45-186 converts a 2600 lb. swing cylinder to 45 degree rotation.

The addition of this spacer requires minor disassembly of the clamp. If you are uncomfortable doing this, please contact an authorized Enerpac Service Center.

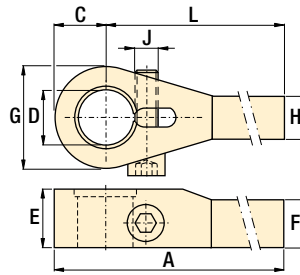




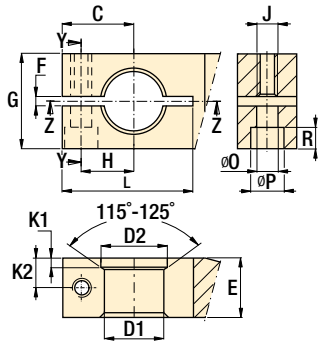
**CAS models** Standard clamp arms



**CAL models** Long clamp arms



**Custom design** (for SU, SL, ST and SC models only)



**Dimensions** in inches [  $\Rightarrow \text{mm}$  ]

Clamp force lbs	Model number	A	C	D	E	F	G	H	J	L	P	Q	Weight lbs
				Ø			Ø					UNC	
<b>▼ Standard clamp arms</b>													
500	<b>CAS-21</b>	1.60	0.38	.393-.395	0.63	0.4	0.76	0.5	.250-28 UNF	1.22	0.97	.250-20	0.1
1250	<b>CAS-51</b>	2.39	0.50	.630-.631	0.76	0.45	1.00	0.62	.312-24 UNF	1.89	1.58	.312-18	0.8
2025	<b>CAS-92</b>	2.99	0.79	.985-.986	0.99	0.62	1.58	0.86	M10 X 1,25	2.21	1.78	M10x1.5	0.7
2600	<b>CAS-121</b>	3.13	0.70	.876-.877	1.20	0.64	1.40	0.82	.375-24 UNF	2.44	2.03	.375-16	1.0
4200	<b>CAS-201</b>	3.72	0.95	1.260-1.262	1.19	0.83	1.90	1.18	.500-20 UNF	2.77	2.18	.500-13	1.0
7600	<b>CAS-351</b>	4.65	1.38	1.497-1.498	1.58	1.17	2.76	1.18	.625-18 UNF	3.27	2.68	.625-11	3.0
<b>▼ Long clamp arms</b>													
500	<b>CAL-22</b>	3.63	0.38	.393-.395	0.63	0.42	0.76	0.45	M6x1.0	3.25	-	-	0.2
1250	<b>CAL-52</b>	5.81	0.50	.630-.631	0.76	0.45	1.00	0.56	M8x1.0	5.31	-	-	1.0
2025	<b>CAL-92</b>	7.09	0.79	.985-.986	0.99	0.63	1.58	0.71	M10x1,25	6.30	-	-	1.2
2600	<b>CAL-122</b>	7.06	0.70	.876-.877	1.20	0.63	1.40	0.73	M10x1,5	6.36	-	-	1.5
4200	<b>CAL-202</b>	7.95	0.95	1.260-1.262	1.19	0.83	1.90	1.00	M12x1,25	7.00	-	-	1.5
7600	<b>CAL-352</b>	8.47	1.38	1.497-1.498	1.58	1.33	2.76	1.19	M16x1,50	7.09	-	-	4.2

Clamp force lbs	C	D1 <sup>1)</sup>	D2	E	F	G	H	J	K1	K2	L	O	P	R
		Ø	Ø									Ø	Ø	
<b>▼ Custom design clamp arms <sup>2)</sup></b> (Recommended machining dimensions)														
500	.61	.393-.394	.495-.497	.63	.06-.12	.79	.37	M5x0,8	.122-.138	.33	.98-1.10	.22	.49	.22
1250	.79	.623-.631	.727-.729	.75	.06-.12	1.18	.53	M6x1,0	.161-.177	.39	1.38-1.57	.26	.43	.26
2025	1.18	.984-.985	1.096-1.100	.98	.06-.12	1.57	.87	M8x1,25	.154-.165	.49	2.17-2.36	.35	.55	.35
2600	1.12	.8756-.8766	1.002-1.006	1.18	.06-.12	1.38	.70	.375-24 UNF	.272-.287	.50	2.05-2.25	.39	.63	.31
4200	1.38	1.260-1.261	1.398-1.402	1.18	.06-.12	2.36	.98	M10x1,5	.201-.217	.59	2.44-2.64	.43	.67	.43
7600	1.57	1.496-1.497	1.634-1.638	1.57	.06-.12	2.76	1.18	M10x1,5	.193-.209	.79	3.15-3.35	.43	.67	.43

<sup>1)</sup> Surface roughness for D1 should be 63 micro inches.  
<sup>2)</sup> Not for use with Collet-Lok swing clamps.

Force: 500 - 7600 lbs

Pressure: 500 - 5000 psi

- E** Brazos de amarre
- F** Bras de bridage
- D** Spannarme

**Options**

Gauges and accessories

190 ▶



Flow control valves

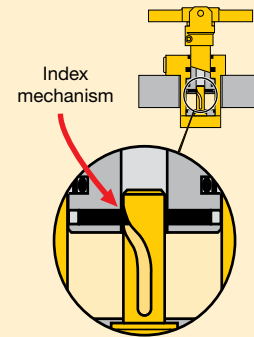
155 ▶



**Important**

**Do not exceed maximum oil flow.**

If flow rates are exceeded, swing cylinder indexing mechanism may be permanently damaged.



When designing custom clamp arms, the flow rates must be further reduced. This rating should be in proportion to the mass and the center of gravity of the clamp arm.

**Example:**

If the mass of the arm is twice that of the long arm, flow rates must be reduced by 50%.

# Pivoting T-Arms *for double-acting swing clamps*

Shown: CAC-202, CAPT-202; CAC-352, CAPT-352



Clamp arms are used to transmit the force generated by the swing cylinder to the workpiece. The T-arm clamps two workpieces simultaneously with one swing cylinder. Enerpac recommends using the pivoting T-arms with double-acting swing clamps of the SU, SL, ST and SC-series.

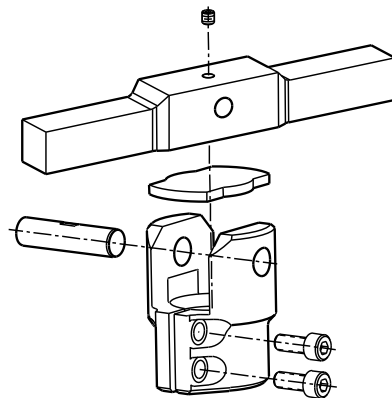
## Clamping two workpieces with one cylinder

...quick and precise clamp arm positioning

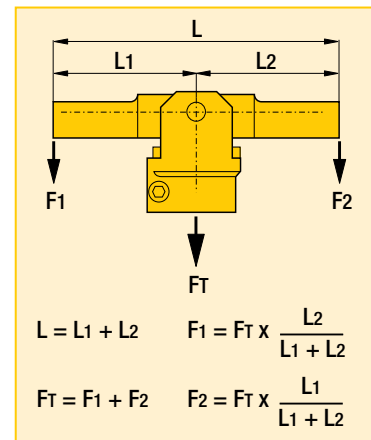
- Easy and precise location of the clamp arm in any position
- Arm can be easily installed and fastened while the cylinder is mounted in the fixture to allow exact arm positioning
- Vise not required for fastening arms or threaded into the fixture
- CAC-92, -202 and -352 are only to be used on double-acting cylinders

### **i** Allowable flow vs arm length

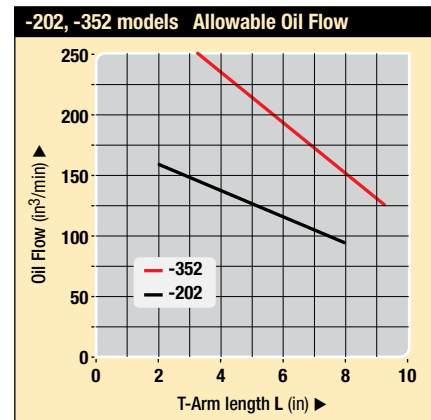
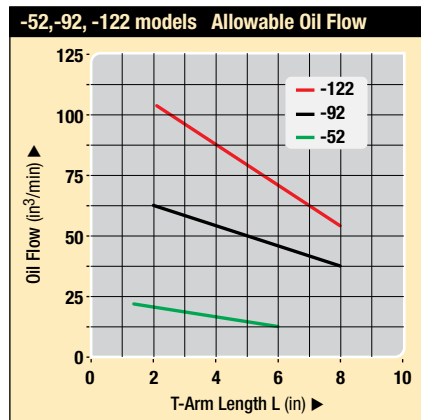
The distribution of the clamp arm force is based upon the length of the T-arm as measured from the pivoting point.



### **!** Important



Two workpieces are clamped simultaneously with one double-acting swing cylinder by using the Enerpac pivoting T-arm.

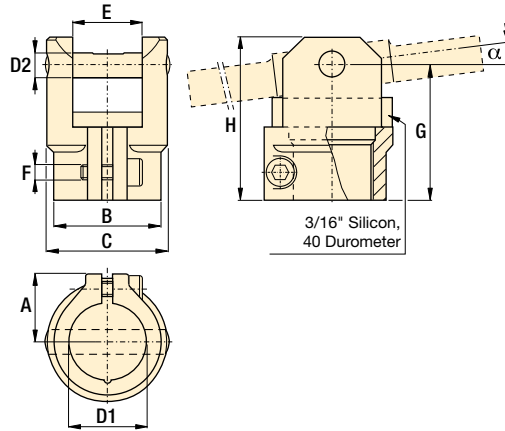


Shown: CAC-202



**CA models**

Collars for T-arms



**Collars - Dimensions in inches** [ ]

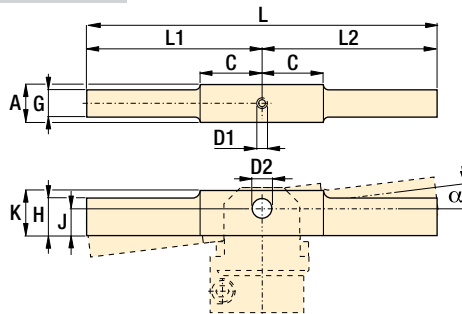
Clamp. force lbs	Model number	Max. tilt angle $\alpha$	A	B	C	D1	D2	E	F	G	H	lbs
			mm									
<b>▼ Collars for T-arms</b>												
1250	<b>CAC-52</b>	20°	.65	.95	1.10	.63	.24	.63	M4x0,7	1.26	88	.20
2025	<b>CAC-92</b>	14°	.87	1.36	1.54	.99	.32	.89	M5x0,8	1.70	115.72	.44
2600	<b>CAC-122</b>	14°	.87	1.36	1.54	.88	.32	.89	M5x0,8	1.70	115.72	.44
4200	<b>CAC-202</b>	10°	1.07	1.84	2.15	1.26	.39	1.13	M6x1,0	2.02	138.60	1.03
7600	<b>CAC-352</b>	10°	1.34	2.15	2.48	1.50	.55	1.39	M8x1,25	2.50	173.80	1.76

Shown: CAPT-202



**CAPT models**

T-arms (for SU, SL, ST and SC swing clamps)



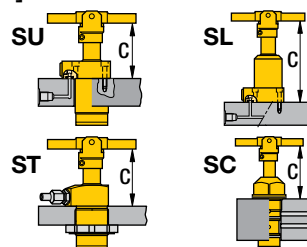
**T-arms - Dimensions in inches** [ ]

Clamp. force lbs	Model number	A	C	D1*	D2	G	H	J	K	L	L1	L2	lbs
				mm									
<b>▼ Pivoting T-arms</b>													
1250	<b>CAPT-52</b>	.61	1.00	M3x0,5	.237-.241	.50	.50	.39	.75	6.00	3.00	3.00	.59
2025	<b>CAPT-92</b>	.87	1.50	M4x0,7	.316-.320	.72	.72	.59	.87	8.01	4.00	4.00	1.45
2600	<b>CAPT-122</b>	.87	1.50	M4x0,7	.316-.320	.72	.72	.59	.87	8.01	4.00	4.00	1.45
4200	<b>CAPT-202</b>	1.12	1.25	M6x1,0	.395-.399	.87	.87	.64	1.13	8.01	4.00	4.00	2.11
7600	<b>CAPT-352</b>	1.37	.99	M6x1,0	.552-.556	1.18	1.18	.73	1.37	9.01	4.50	4.50	3.92

\* Note: D1 equals set screw thread size. Set screw must be long enough to secure the pivot pin.

**Installation dimensions in inches** [ ]

Clamping force lbs	T-arm model	SU-series C	SU-L-series C	SL-series C	ST-series C	SC-series C
<b>▼ T-arm installation dimensions - Fully unclamped position</b>						
1250	-52	2.90	-	5.50	2.90	3.19
2025	-92	3.13	3.91	6.13	3.32	-
2600	-122	3.55	4.28	6.93	3.55	3.87
4200	-202	3.57	-	6.99	3.97	-
7600	-352	4.04	4.69	7.84	4.31	-



**Force: 1250 - 7600 lbs**

**Pressure: 500 - 5000 psi**

- E** Brazos de amarre
- F** Bras de bridage
- D** Spannarme

**Options**

Gauges and accessories

190 ▶



Flow control valves

155 ▶



Download CAD files from [www.enerpacwh.com](http://www.enerpacwh.com)



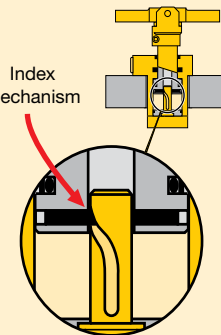
**30, 45, and 60 degree rotations are available upon request.**

**Important**

**For high cycle applications use double-acting cylinders.**

**Do not exceed maximum oil flow.**

If flow rates are exceeded, swing cylinder indexing mechanism may be permanently damaged.



When designing custom clamp arms, the flow rates must be further reduced. This rating should be in proportion to the mass and the center of gravity of the clamp arm.

**Example:**

*If the mass of the arm is twice that of the long arm, flow rates must be reduced by 50%.*

# Upreach clamp arms *for swing clamps*

Shown: CAU-352, CAU-122, CAU-22

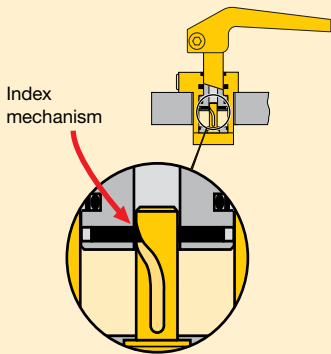


**EnergyPac's patented upreach clamp arm design attaches to the hydraulic swing cylinder, allowing parts to be clamped at various distances from the hydraulic cylinder. Clamp arms are available in an extended length which can be machined to fit your unique requirements.**

## Important

### Do not exceed maximum oil flow.

If flow rates are exceeded, swing cylinder indexing mechanism may be permanently damaged.



When designing custom clamp arms, the flow rates must be further reduced. This rating should be in proportion to the mass and the center of gravity of the clamp arm.

### Example:

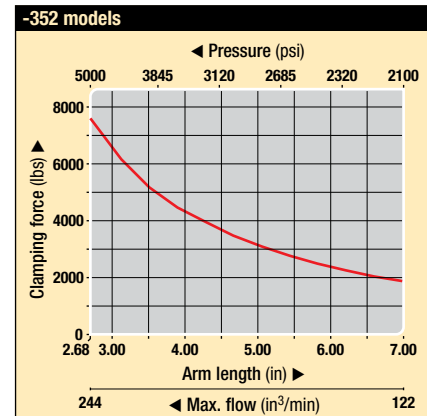
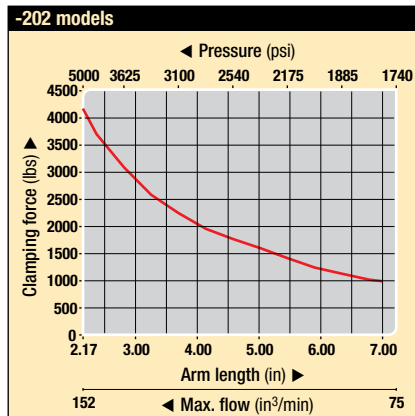
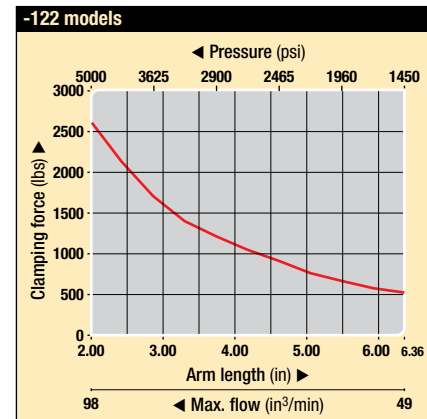
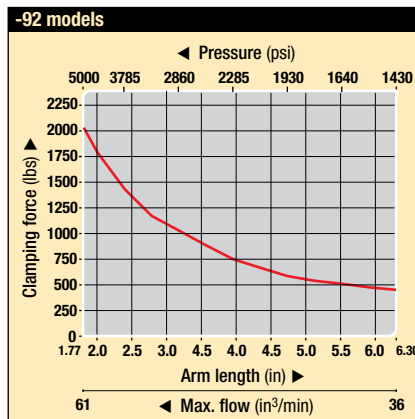
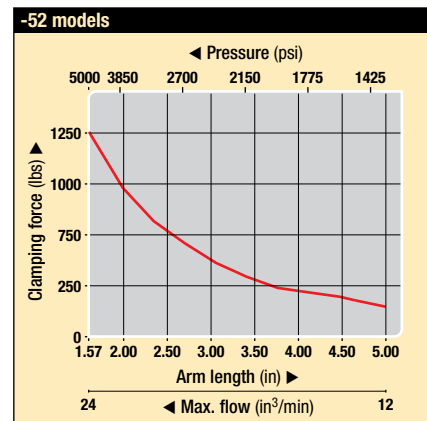
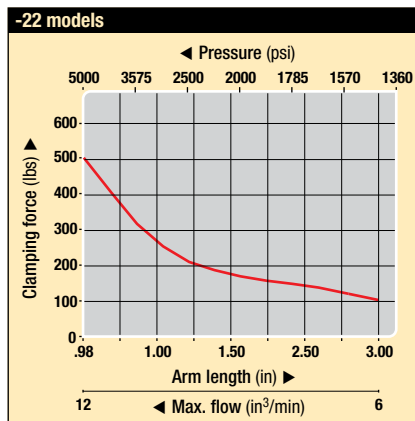
*If the mass of the arm is twice that of the long arm, flow rates must be reduced by 50%.*

## Patented Design

- Upreach design allows more flexible part clamping
- Arm can be easily installed and fastened while the cylinder is mounted in the fixture to allow exact arm positioning
- Vise not required for fastening arms
- Arm length can be cut to desired size
- Angled arm with minimal deflection achieves maximum workpiece contact

## Pressure vs clamping force

The use of different length clamp arms requires reduction in applied pressure and resulting clamp force. The charts below show this relationship.

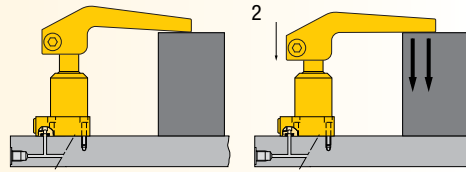


**i** Angled arms use deflection to improve clamping

**Angled arms**

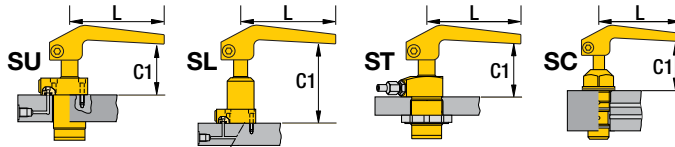
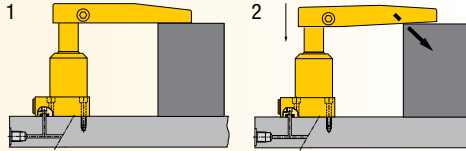
Tip engages part first and contact increases as clamping force is applied.

Eliminates “push” effect caused by straight arms deflecting under load.



**Straight Arms**

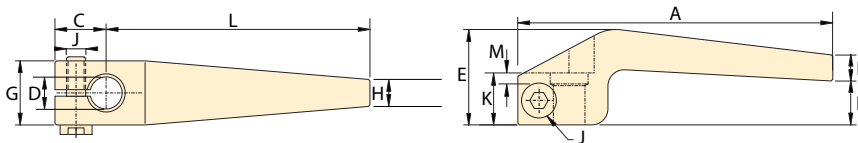
Great for most applications, but standard deflection can cause part movement and lower the true clamping force.



**A** Installation dimensions in inches [  $\text{D}$  ]

Model number	Clamp force	L	SU-Series C1	SL-Series C1	ST-Series C1	SC-Series C1
<b>▼ Stock length dimensions</b>						
CAU-22	100	3.25	2.23	4.32	2.23	2.09
CAU-52	200	5.31	2.82	5.42	2.82	3.10
CAU-92	450	6.30	2.90	5.89	3.10	-
CAU-122	500	6.36	3.29	6.67	3.29	3.61
CAU-202	1000	6.99	3.47	6.90	3.75	-
CAU-352	1900	7.09	3.90	7.56	4.18	-
<b>▼ Minimum length dimensions</b>						
CAU-22	500	0.98	2.35	4.44	2.35	2.21
CAU-52	1250	1.57	3.02	5.62	3.02	3.30
CAU-92	2025	1.77	3.14	6.13	3.34	-
CAU-122	2600	2.00	3.52	6.90	3.52	3.84
CAU-202	4200	2.17	3.72	7.15	4.00	-
CAU-352	7600	2.68	4.21	7.87	4.49	-

**CAU models** Upreach clamp arms



**A** Dimensions in inches [  $\text{D}$  ]

Model number	A	B	B	C	D	E	F	F	G	H	H	J	K	L	L	M	
	Std.	Min.	Min.				Std.	Min.		Std.	Min.	mm		Std.	Min.		
CAU-22	3.88	0.54	0.66	0.63	.393-.394	1.17	0.32	0.54	0.79	0.33	0.82	M6 x 1,0	0.64	3.25	0.98	0.04	0.3
CAU-52	6.10	0.85	1.05	0.79	.630-631	1.65	0.26	0.57	1.18	0.47	1.25	M6 x 1,0	0.75	5.31	1.57	0.05	0.9
CAU-92	7.48	0.93	1.17	1.18	.985-.986	1.89	0.43	0.76	1.57	0.57	1.61	M8 x 1,25	0.98	6.30	1.77	0.09	1.7
CAU-122	7.48	1.11	1.34	1.12	.876-.877	2.25	0.50	1.15	1.50	0.65	1.56	M10 x 1,5	1.18	6.36	2.00	0.15	2.2
CAU-202	8.37	1.27	1.52	1.38	1.260-1.261	2.41	0.52	0.96	2.36	0.68	2.14	M10 x 1,5	1.18	6.99	2.17	0.11	3.7
CAU-352	8.66	1.62	1.93	1.57	1.497-1.498	3.14	0.74	1.35	2.60	0.62	2.13	M10 x 1,5	1.58	7.09	2.68	0.07	5.9

Refer to clamping force charts on page 36.  
Never cut shorter than indicated minimum length.

Force: 100 - 7600 lbs  
Pressure: 500 - 5000 psi

- E** Brazos de amarre
- F** Bras de bridage
- D** Spannarme

**i** Options

Sequence valves 152 ▶

Flow control valves 155 ▶

Download CAD files from [www.enerpacwh.com](http://www.enerpacwh.com)

Swing clamps

Work supports

Linear cylinders

Power sources

Valves

Pallet components

System components

Yellow pages

Shown: SC-3, SC-1



## SC series

These swing clamps rotate 90° as they begin their stroke, continuing without rotation for the final clamping stroke. Cylinders can be changed to left swing, right swing, or pull applications by loosening the side plug and then rotating the plunger to a desired position.

The SC-1 and SC-3 include a retract spring for single-acting operation. Both cylinders can be operated as double-acting cylinders by connecting a retract line to the vent port.

## Changeable swing function

...with 360° fully adjustable clamp arm

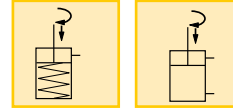
- Changeable swing function: clamp arm movement can be adjusted to left or right swing, or straight pull function
- 88-92° clamp arm swing arc
- Easy installation: built-in mountings and brackets
- Compact design for use in limited space applications
- Easy and precise locating of arm for clamp positioning
- Single or double-acting cylinders to suit variety of hydraulic requirements

Force: 500 - 2164 lbs

Stroke: .78 - 1.49 inch

Pressure: 1500 - 3000 psi

- Ⓔ Cilindros giratorios
- Ⓕ Vérins de bridage pivotants
- Ⓓ Schwenkspannzylinder



Arm length in	Max. pressure psi	Clamping force lbs
---------------	-------------------	--------------------

### ▼ SC-1

–	3000	2640
2.00 <sup>2)</sup>	3000	2164
3.00	3000	1960
4.00	3000	1740
5.00	2400	1200
6.00	2000	840

### ▼ SC-3

–	3000	700
1.00 <sup>2)</sup>	3000	500
2.00	2000	250

## Selection chart

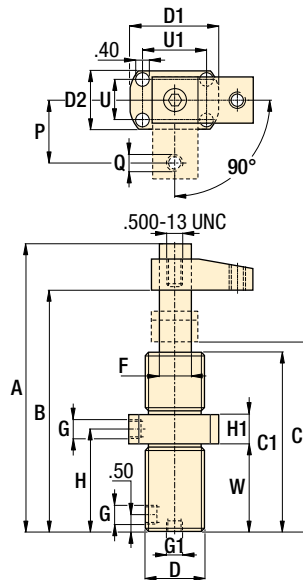
Clamping force <sup>1)</sup>	Stroke		Model number	Cylinder effective area		Oil capacity	
	lbs	in		in <sup>2</sup>	in <sup>3</sup>		
2164	.50	1.49	SC-1	.98	1.767	1.47	2.65
500	.25	.78	SC-3	.245	.442	.184	.331

<sup>1)</sup> With standard clamp arm (included with cylinder).

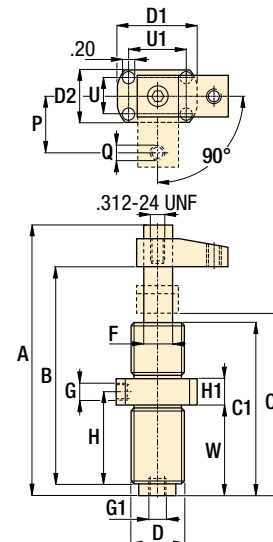
**Note:** - Long clamp arms can be fabricated by the user.  
- For long clamp arms, use VFC series flow control valves.

<sup>2)</sup> Standard clamp arm (included).

### SC-1



### SC-3



## Product dimensions in inches [ $\pm$ ]

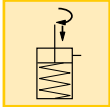
Model number	A	B	C	C1	D	D1	D2	F	G	G1	H	H1	P	Q	U	U1	W	lbs
SC-1	8.88	7.37	5.87	5.74	1.875-16UN	2.90	1.88	1.00	.250-18	.125-27	3.31	.88	2.00	.375-16	1.28	2.06	2.87	6
SC-3	5.27	4.26	3.71	3.48	1.00-12UNF	2.00	1.13	.50	.125-27	.125-27	2.15	.63	1.00	.250-20	.75	1.50	2.03	2

Force: 1375 - 4375 lbs

Stroke: .25 - .43 inch

Pressure: 1200 - 2500 psi

- E** Cilindros giratorios
- F** Vérins de bridage pivotants
- D** Schwenkspannzylinder



## Adjustable clamping stroke

...turns clockwise or counter-clockwise

- Adjustable bolt in clamp arm for clamping stroke adjustment
- Low profile, ideal for limited space applications
- Quick swing action allows clamp arm to swing free of cutter and reclamp after it has passed
- 94-100° clamp arm swing arc

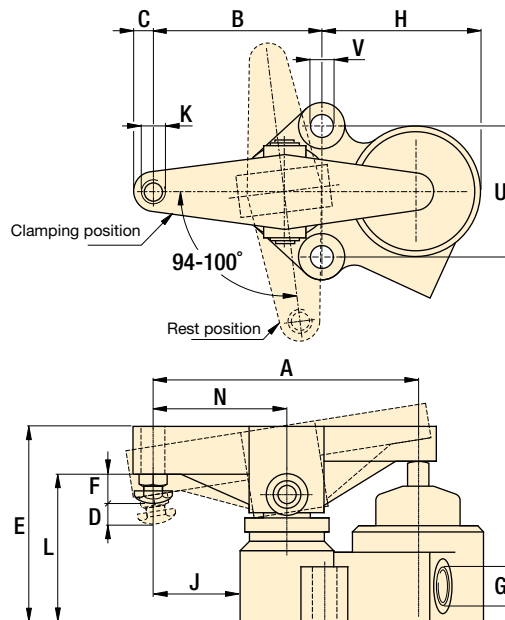
Shown: ASC-30



### ASC series

Clamping arm rotates 97° clockwise or counter-clockwise (requires easily changed rotation spring) to position itself over the workpiece. Then, a vertical plunger exerts an upward thrust on the back end of the swing arm providing a powerful downward pressure to clamp the workpiece.

ASC-30, -100



## Selection chart

Clamping force	Stroke	Model number	Operating pressure	Cylinder effective area	Oil capacity	Max. oil flow	
lbs	in		psi	in <sup>2</sup>	in <sup>3</sup>	in <sup>3</sup> /min	lbs
1375	.25	<b>ASC-30</b>	1200 - 2500	.55	.30	115	6
4375	.43	<b>ASC-100</b>	1200 - 2500	1.76	1.22	115	18

## Product dimensions in inches [ ]

Model number	A	B	C	D	E	F	G	H	J	K	L	N	U	V	
							NPT		UN			Ø			
<b>ASC-30</b>	5.00	3.38	.50	.25	3.50	.75	.125-27	2.75	1.63	.500-13	2.75	2.50	2.50	.41	
<b>ASC-100</b>	7.00	4.50	.53	.43	5.25	.73	.125-27	4.25	2.25	.500-13	4.00	3.50	3.50	.63	

### Important

For high cycle applications use double-acting cylinders.

View of a machining fixture with ASC-30 clamping cylinders.



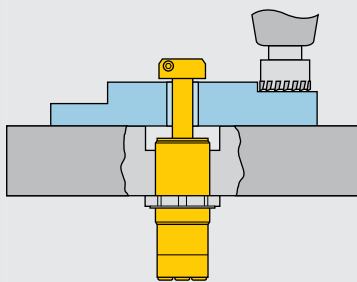
# Three-position swing cylinder *Application & selection*

Shown: WTR-24



## WTR series

The three position swing cylinder rotates 90° only after the plunger has completely extended. This feature allows the clamp to be mounted beneath the workpiece, where the clamp travels through the part for clamping.

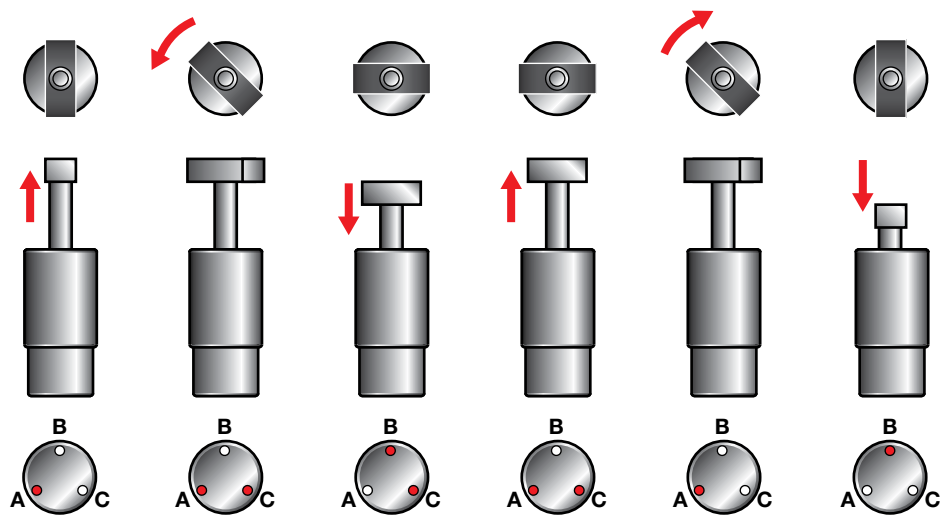


## Unobstructed part loading

- Plunger rotates only when cylinder is fully extended, to minimize obstructions
- Ideal for mounting beneath the fixture, as the clamp does not rotate until the workpiece has been cleared
- Stainless steel body for additional corrosion resistance
- Three port design for fewer hydraulic connections
- Fully threaded body for easy installation
- Standard two sided clamp arm included
- Clamp arm design makes mounting easy

## Operation sequence

The three position swing cylinder is ideal for parts which have a through hole. The clamp allows completely unobstructed part loading.



### Step 1

Pressurize port A. Plunger extends through workpiece.

### Step 2

Keep port A pressurized. Pressurize port C. Plunger makes 90° flat rotation.

### Step 3

Keep port C pressurized. Pressurize port B. Plunger retracts: clamp force is applied.

### Step 4

Keep port C pressurized. Pressurize port A. Plunger extends: clamp force is released.

### Step 5

Keep port A pressurized. Depressurize port C. Plunger makes 90° flat rotation.

### Step 6

Pressurize port B. Plunger retracts through workpiece.

## Selection chart

Clamping force <sup>1)</sup>	Stroke	Model number <sup>2)</sup>	Cylinder effective area		Oil capacity		Max. oil flow	Maximum cycle rate
			in <sup>2</sup>	in <sup>2</sup>	in <sup>3</sup>	in <sup>3</sup> /min		
lbs	in		Clamp.	Unclamp.	Clamp.	Unclamp.	in <sup>3</sup> /min	cycles /min
5000	2.50	WTR-24*	.98	1.77	2.5	4.4	116	4

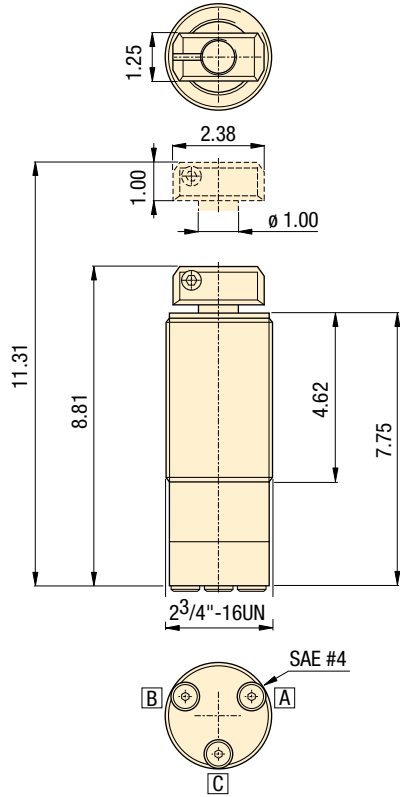
<sup>1)</sup> When using optional CA-28 clamp arm, max. operating pressure is 2000 psi.

<sup>2)</sup> Standard clamp arm included.

\* This product is made to order. Please contact Enerpac for delivery information before specifying in your design.



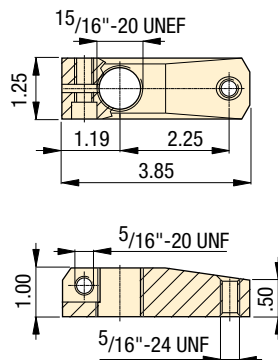
**WTR-24**



- A** = Advance
- B** = Retract
- C** = Rotate 90°

***i* Optional CA-28 clamp arm**

The WTR-24 has a two-sided standard clamp arm included. The CA-28 clamp arm can be used to secure the workpiece on one side only, though the clamping pressure must be reduced to 2000 psi maximum.

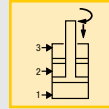


**Force: 1960 - 5000 lb**

**Stroke: 2.50 inch**

**Pressure: 2000 - 5000 psi**

- E** Cilindros giratorios
- F** Vérins de bridage pivotants
- D** Schwenkspannzylinder



***i* Options**

**High pressure filters**

**193**



**Fittings**

**194**



**Valves**

**136**



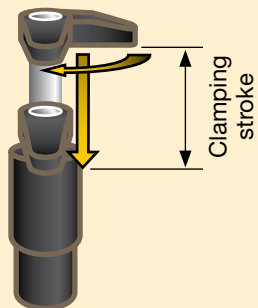
***w* Important**

**It is highly recommended that system filtration be used to ensure reliable operation.**

**Do not exceed maximum pressure and flow rates.**

**For recommended valving schemes, please refer to page 42.**

**Clamp arm movement: 90° ± 3° flat rotation.**

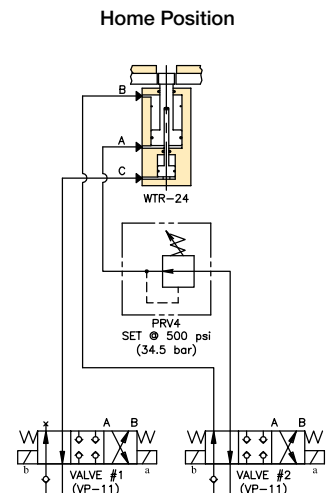
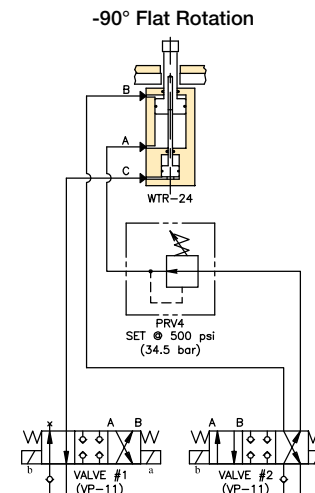
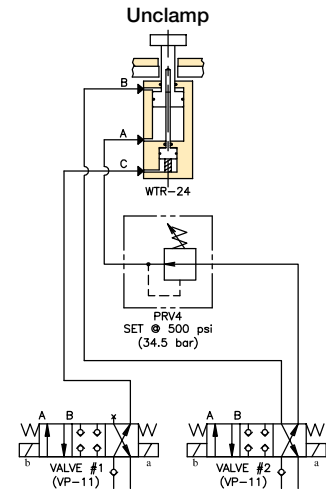
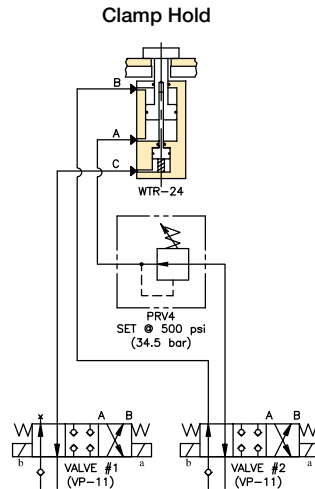
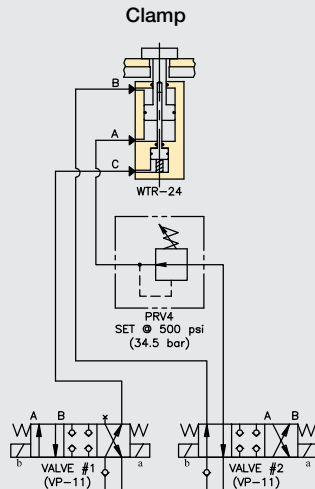
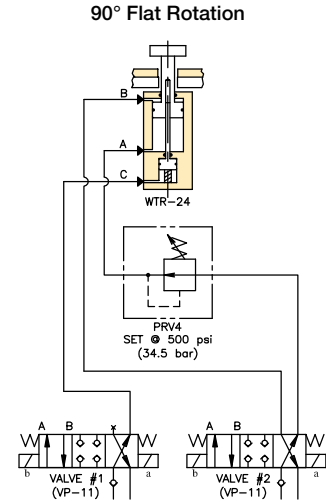
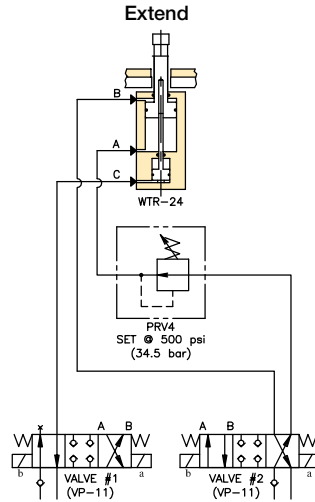
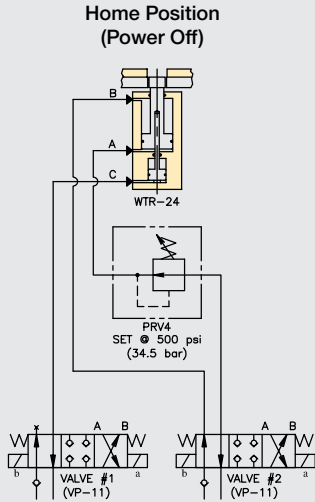


## ⚠ Important




Circuit must include a Pressure Reducing Valve (PRV-4) in the "A" port circuit to reduce the pressure in Unclamp to prevent damage to the cylinder.

## Recommended valving system for WTR-24

- 4-way 3-position closed center valves are recommended
- Valves can be manual or solenoid operated
- Valves must be cycled as shown for proper actuation of the WTR-24



# Work supports

	▼ series	▼ page	
<b>Work support range overview</b>		<b>44 - 45</b>	
<b>Hydraulic advance work supports</b>	<b>WF</b>	<b>46 - 47</b>	
<b>Spring advance work supports</b>	<b>WS</b>	<b>48 - 49</b>	
<b>Work support mounting dimensions</b>	<b>WF, WS</b>	<b>50 - 51</b>	

## Work Supports

Enerpac's line of work support cylinders gives you maximum holding force in a compact package. Incorporating innovative material combinations, our work supports feature the lowest lock-up pressures in the industry. Also, the use of corrosion resistant materials enables Enerpac work supports to stand up time and time again to even the most abrasive applications.



## Technical support

Refer to the "Yellow Pages" of this catalog for:

- Safety instructions
- Basic hydraulic information
- Advanced hydraulic technology
- FMS (Flexible Machining Systems) technology
- Conversion charts and hydraulic symbols

 197 ▶

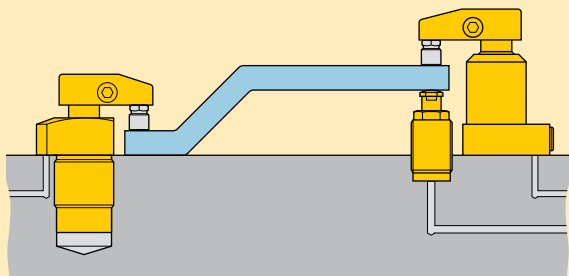
# Work supports

Shown: WFL-111, WFC-72, WFL-441



▶ The Enerpac work support is a hydraulic means of positively supporting the workpiece to minimize deflections.

The work support automatically adjusts to the contour of the workpiece, and then locks in position. This support then adds rigidity to the fixtured component to minimize machining variations.



■ Lower flange work supports, placed close to the machining area to minimize deflection of the workpiece.



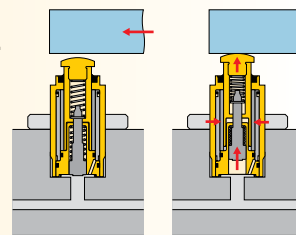
## Wide range of sizes and types to efficiently support workpiece

- Low pressure lock-up capability enables the use of machine tool hydraulic systems
- High rated support capacities allow for more compact fixture design
- Corrosion resistant materials, compatible with most coolants and environments
- Threaded and manifold air vent ports allow fixturing that prevents coolants from being drawn into the system
- Minimized deflection increases machining accuracy
- Multiple mounting configurations allow design flexibility

## i Select your work support method:

### WF series, Hydraulic advance

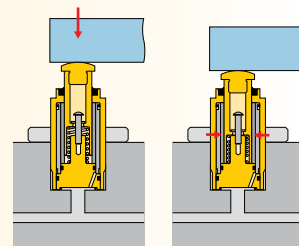
- Retracted plunger allows unobstructed workpiece loading.
- Internal hydraulic plunger advances allowing external plunger to advance under spring load. Bronze sleeve squeezes and holds plunger in fixed position.



□ 46 ▶

### WS series, Spring advance

- Workpiece weight compresses the spring of the extended plunger.
- When pressurized, the internal bronze sleeve squeezes and holds the plunger in fixed position.
- Can be operated as air advance.

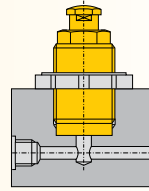


□ 48 ▶

## Select your mounting method:

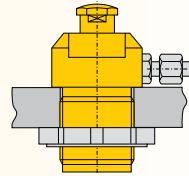
### Manifold mount

- Does not require external plumbing
- Compact design, when space is at a premium
- Internal plunger thread for optional contacts



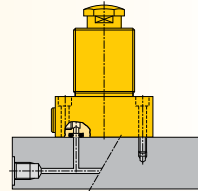
### Threaded body

- Ability to adjust height
- Plumbed from either side or bottom
- Internal plunger thread for optional contacts



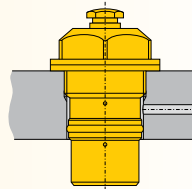
### Lower flange

- Plumbed directly or manifold mounted
- No fixture hole required
- Easy to assemble or disassemble
- Internal plunger thread for optional contacts







### Cartridge style

- Does not require external plumbing
- Allows close clustering of work supports
- Compact design, when space is at a premium
- Internal plunger thread for optional contacts



## Product selection

Maximum support force	Stroke	Manifold mount	Threaded body	Lower flange	Cartridge style
lbs	in				
<b>▼ Hydraulic advance</b>		Model number			
1650	.39	<b>WFM-71</b>	-	-	-
1650	.40	-	<b>WFT-71</b>	-	-
2500	.40	-	-	<b>WFL-111</b>	-
5000	.41	-	-	<b>WFL-221</b>	-
7500	.53	-	-	<b>WFL-331</b>	-
10,000	.65	-	-	<b>WFL-441</b>	-
1650	.39	-	-	-	<b>WFC-72</b>
2500	.36	-	-	-	<b>WFC-112</b>
5000	.41	-	-	-	<b>WFC-222</b>
<b>▼ Spring advance</b>		Model number			
1650	.38	<b>WSM-71</b>	-	-	-
1650	.38	-	<b>WST-71</b>	-	-
2500	.38	-	-	<b>WSL-111</b>	-
5000	.38	-	-	<b>WSL-221</b>	-
7500	.54	-	-	<b>WSL-331</b>	-
10,000	.66	-	-	<b>WSL-441</b>	-
1650	.38	-	-	-	<b>WSC-72</b>
2500	.38	-	-	-	<b>WSC-112</b>
5000	.47	-	-	-	<b>WSC-222</b>

Force: 1650 - 10,000 lbs

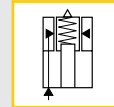
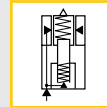
Stroke: .36 - .65 inch

Pressure: 700 - 5000 psi

**E** Cilindros de soporte

**F** Vérin anti-vibreur

**D** Abstützylinder



## Options

Swing cylinders

 22 ▶



Accessories

 86 ▶



In-line filters

 193 ▶



Sequence valves

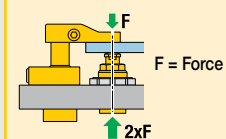
 152 ▶



## Important

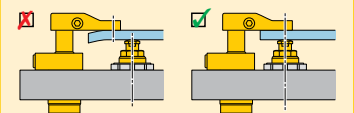
### WARNING!

Support force and clamping force must be matched. Support force should be at least 150% of clamping force.



Do not exceed maximum flow rates to avoid premature lockup.

Always center load over work support.



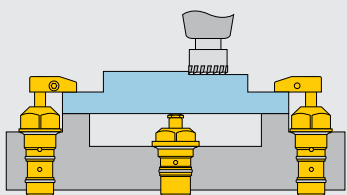
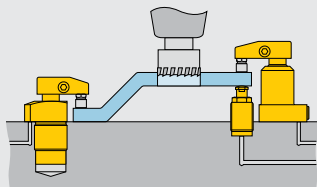
# Work supports - Hydraulic advance

Shown: WFM-71, WFL-111



## WF series

Enerpac work supports provide either additional non-fixed location points to the clamps, or support to larger or thin section workpiece components, always in order to minimize workpiece deflection during machining.



In order to load the workpiece sideways over the work supports, hydraulic advanced models are being used.



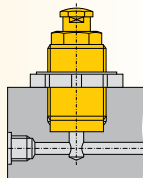
## For unobstructed part loading

- Plunger stays retracted until pressure is applied allowing unobstructed loading
- Low pressure lock-up capability enables the use of machine tool hydraulic systems
- High rated support capacities allow for more compact fixture design
- Corrosion resistant materials – compatible with most coolants and environments
- Threaded and manifold air vent ports allow fixturing that prevents coolants and debris from being ingested into the mechanism
- Minimized deflection increases machining accuracy
- Multiple mounting configurations for design flexibility
- Contact bolt included

## Four mounting styles

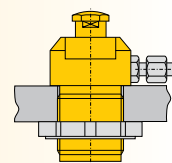
### WFM series, Manifold models

Eliminates the need for fittings and tubing on the fixture.



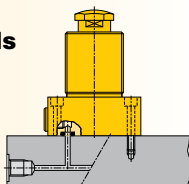
### WFT series, Threaded models

Offers the flexibility of side or bottom porting.



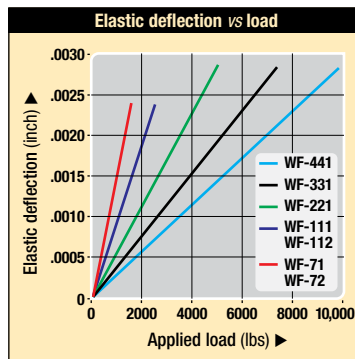
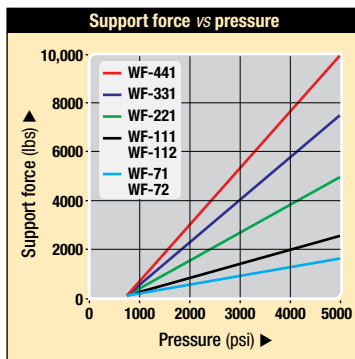
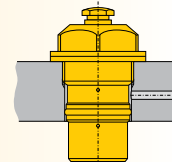
### WFL series, Lower flange models

Plumbed directly – no fixture hole required.



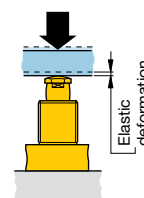
### WFC series, Cartridge models

Can be designed into narrow fixture plates as thru-hole mounting is fully functional.



## Deflection chart:

Elastic deformation of the work support resulting from the application of load.

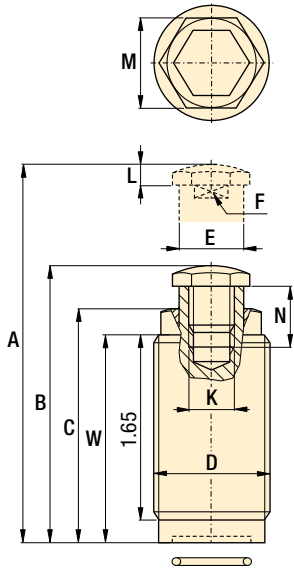


## Product selection

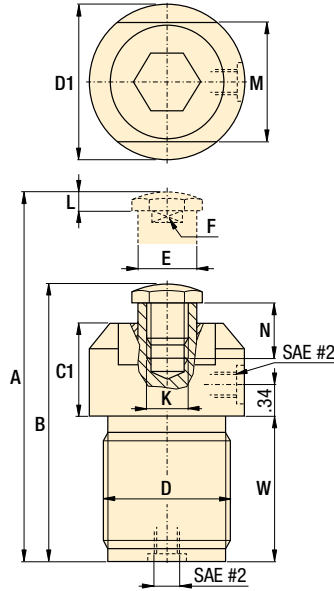
Max. support force	Support plunger stroke	Manifold mount	Threaded body	Lower flange	Cartridge style	Operating pressure		Plunger contact spring force		Oil capacity	Max. oil flow
						psi min.	psi max.	lbs ext.	lbs retr.		
1650	.39	WFM-71	-	-	-	700	5000	2.0	5.8	.04	40
1650	.40	-	WFT-71	-	-	700	5000	2.0	5.8	.04	40
2500	.40	-	-	WFL-111	-	700	5000	3.4	5.2	.06	60
5000	.41	-	-	WFL-221	-	700	5000	2.1	19.5	.19	190
7500	.53	-	-	WFL-331	-	700	5000	4.0	17.5	.24	240
10,000	.65	-	-	WFL-441*	-	700	5000	3.3	22.0	.30	300
1650	.39	-	-	-	WFC-72	700	5000	2.0	5.8	.04	40
2500	.36	-	-	-	WFC-112	700	5000	3.4	5.2	.06	60
5000	.41	-	-	-	WFC-222	700	5000	2.1	19.5	.19	190

\* This product is made to order. Please contact Enerpac for delivery information before specifying in your design.

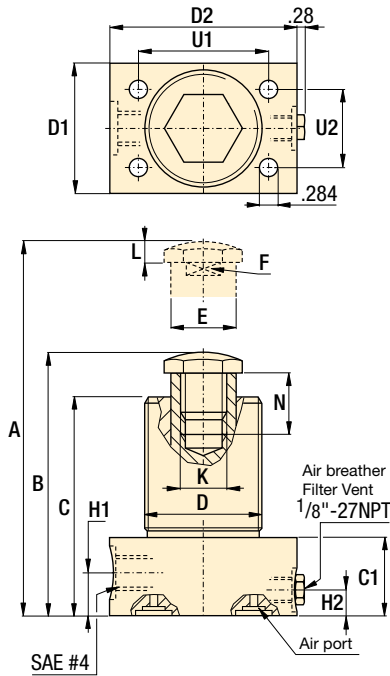
**WFM series**



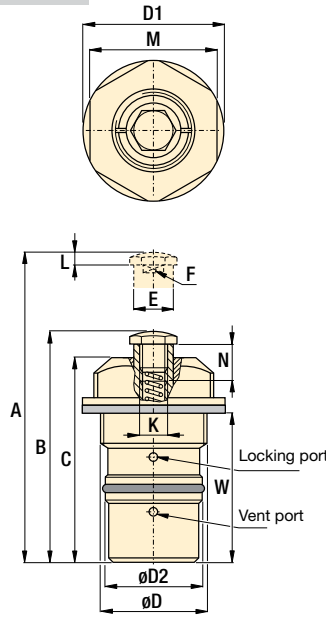
**WFT series**



**WFL series**



**WFC series**

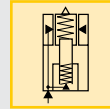


Force: 1650 - 10,000 lbs

Stroke: .36 - .65 inch

Pressure: 700 - 5000 psi

- E** Cilindros de soporte
- F** Vérin anti-vibreur
- D** Abstützylinder



**Options**

**Accessories**

86 ▶



**In-line filters**

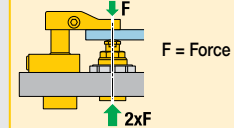
193 ▶



**Important**

**WARNING!**

Support force and clamping force must be matched. Support force should be at least 150% of clamping force.



Do not exceed maximum flow rates to avoid premature lockup.

Custom cylinders including longer stroke lengths are available on request.

**Product dimensions** in inches [ ]

Model number	Capacity lbs	A	B	C	C1	D	D1	D2	E	F	H1	H2	K	L	M	N**	U1	U2	W	
		mm																		
<b>WFM-71</b>	1650	3.02	2.63	2.20	-	1.250-16 UN	-	-	0.591	0.51	-	-	M10x1,5	0.18	0.95	0.51	-	-	2.00	.5
<b>WFT-71</b>	1650	3.53	3.13	-	1.03	1.375-18 UNEF	1.72	-	0.591	0.51	-	-	M10x1,5	0.18	1.34	0.51	-	-	1.65	.5
<b>WFL-111</b>	2500	3.93	3.54	3.10	1.08	1.375-18 UNEF	1.50	2.38ø	0.629	0.49	.56	.70	M10x1,5	0.18	-	0.73	1.62	0.94	-	1.4
<b>WFL-221</b>	5000	4.13	3.72	3.07	1.04	2.625-20 UN	2.75	3.25	1.496	1.00	.55	.52	M20x2,5	0.24	-	0.92	2.19	2.19	-	4.8
<b>WFL-331</b>	7500	4.42	3.89	3.46	1.07	2.88ø	3.00	3.50	1.771	1.18	.53	.43	M20x2,5	0.24	-	0.93	2.44	2.44	-	6.3
<b>WFL-441*</b>	10,000	5.09	4.44	4.06	1.19	3.37ø	3.50	4.00	2.165	1.44	.53	.43	M20x2,5	0.24	-	1.24	2.94	2.94	-	9.5
<b>WFC-72</b>	1650	3.22	2.83	2.46	-	M33x1,5	1.66	1.18	0.591	0.51	-	-	M10x1,5	0.18	1.50	0.51	-	-	1.98	.9
<b>WFC-112</b>	2500	4.03	3.67	3.23	-	M42x1,5	2.25	1.50	0.629	0.49	-	-	M10x1,5	0.18	2.00	0.73	-	-	2.37	2.0
<b>WFC-222</b>	5000	4.56	4.15	3.60	-	M60x1,5	3.00	2.25	1.496	1.00	-	-	M20x2,5	0.24	2.75	0.92	-	-	2.72	4.0

\* This product is made to order. Please contact Enerpac for delivery information before specifying in your design.  
 \*\* Note: Dimension N is factory set. May change on types 221, 331 and 441 due to adjusted contact spring force.  
 Note: For manifold mounting dimensions (L)50.

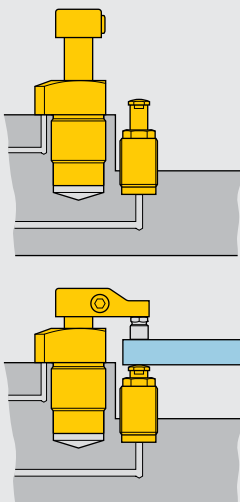
# Work supports - Spring advance

Shown: WSL-111, WSM-71



## WS series

Enerpac work supports provide either additional non-fixed location points to the clamps, or support to larger or thin section workpiece components, always in order to minimize workpiece deflection during machining.



Spring advance work supports with extended plungers, waiting for the next workpiece.



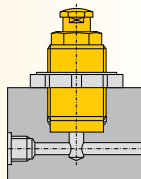
## Spring advance work support contacts workpiece as it is loaded into fixture

- Low pressure lock-up capability enables the use of machine tool hydraulic systems
- High rated support capacities allow for more compact fixture design
- Corrosion resistant materials, compatible with most coolants and environments
- Threaded and manifold air vent ports allow fixturing that prevents coolants from being drawn into the system
- Minimized deflection increases machining accuracy
- Multiple mounting configurations allow design flexibility
- Can be operated as air advance by removing the spring and applying air pressure on the vent port

## Mounting style

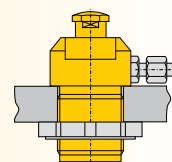
### WSM series, Manifold mount

Eliminates the need for fittings and tubing on the fixture.



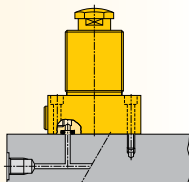
### WST series, Threaded body

Offers the flexibility of side or bottom porting.



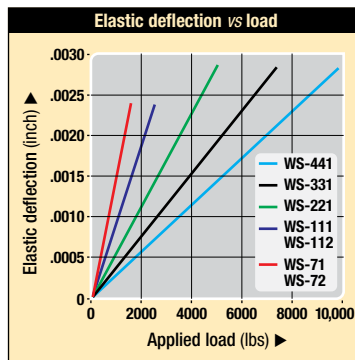
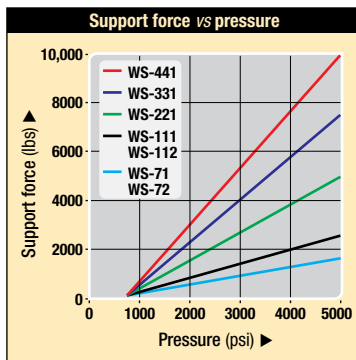
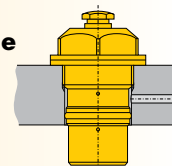
### WSL series, Lower flange

Plumbed directly – no fixture hole required.



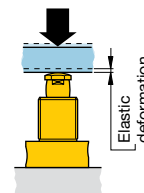
### WSC series, Cartridge mount style

Can be designed into narrow fixture plates as thru-hole mounting is fully functional.



## Deflection chart:

Elastic deformation of the work support resulting from the application of load.

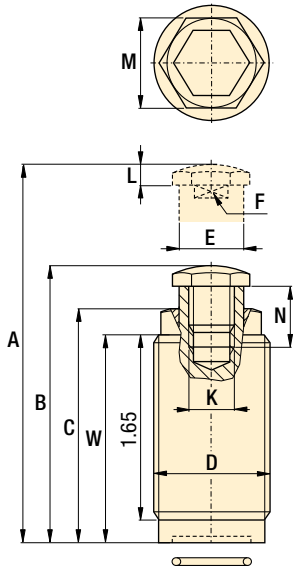


## Product selection

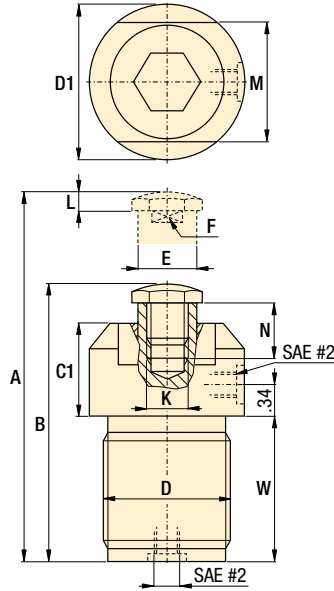
Max. support force	Support plunger stroke	Manifold mount	Threaded body	Lower flange	Cartridge style	Operating pressure		Plunger contact spring force		Oil capacity	Max. oil flow
						psi min.	psi max.	lbs ext.	lbs retr.		
1650	.38	WSM-71	-	-	-	700	5000	2.0	5.8	.04	40
1650	.38	-	WST-71	-	-	700	5000	2.0	5.8	.04	40
2500	.38	-	-	WSL-111	-	700	5000	3.4	5.2	.06	60
5000	.38	-	-	WSL-221	-	700	5000	2.1	19.5	.19	190
7500	.54	-	-	WSL-331	-	700	5000	4.0	17.5	.24	240
10,000	.66	-	-	WSL-441*	-	700	5000	3.3	22.0	.30	300
1650	.38	-	-	-	WSC-72	700	5000	2.0	5.8	.04	40
2500	.38	-	-	-	WSC-112	700	5000	3.4	5.2	.06	60
5000	.47	-	-	-	WSC-222	700	5000	2.1	19.5	.19	190



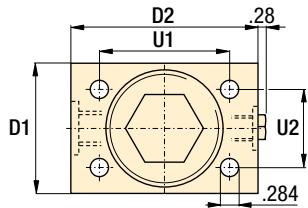
**WSM series**



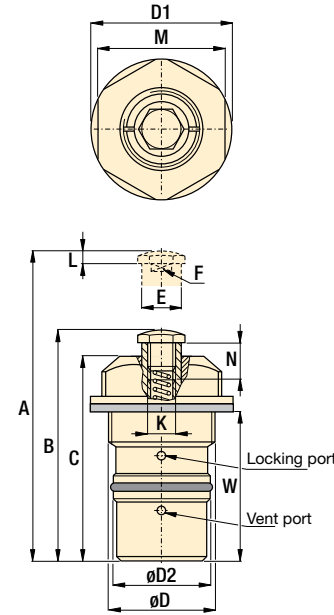
**WST series**



**WSL series**

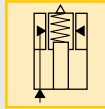


**WSC series**



- Force: 1650 - 10,000 lbs
- Stroke: .38 - .66 inch
- Pressure: 700 - 5000 psi

- E** Cilindros de soporte
- F** Vérin anti-vibreur
- D** Abstützylinder



**Options**

**Accessories**

86 ▶



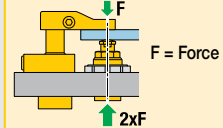
**In-line filters**

193 ▶



**Important**

**WARNING!**  
Support force and clamping force must be matched. Support force should be at least 150% of clamping force.



**Do not exceed maximum flow rates to avoid premature lockup.**

**Custom cylinders including longer stroke lengths are available on request.**

**Product dimensions** in inches [ ]

Model number	Capacity lbs	A	B	C	C1	D	D1	D2	E0	F	H1	H2	K	L	M	N**	U1	U2	W	
		mm																		
<b>WSM-71</b>	1650	3.00	2.62	2.20	-	1.250-16 UN	-	-	.591	.51	-	-	M10x1,5	.18	.95	.51	-	-	2.00	.5
<b>WST-71</b>	1650	3.51	3.13	-	1.03	1.375-18 UNEF	1.72 ø	-	.591	.51	-	-	M10x1,5	.18	1.34	.51	-	-	1.65	.5
<b>WSL-111</b>	2500	3.36	2.98	2.54	.95	1.375-18 UNEF	1.50	2.38	.629	.49	.44	.39	M10x1,5	.18	-	.73	1.62	.94	-	1.4
<b>WSL-221</b>	5000	3.91	3.53	2.95	.98	2.625-20 UN	2.75	3.25	1.496	1.00	.48	.40	M20x2,5	.24	-	.92	2.19	2.19	-	4.8
<b>WSL-331</b>	7500	4.29	3.75	3.37	1.07	2.88 ø	3.00	3.50	1.771	1.18	.51	.37	M20x2,5	.24	-	.93	2.44	2.44	-	6.3
<b>WSL-441*</b>	10,000	4.99	4.33	4.04	1.19	3.37 ø	3.40	4.00	2.165	1.44	.53	.43	M20x2,5	.24	-	1.24	2.94	2.94	-	9.5
<b>WSC-72</b>	1650	3.20	2.82	2.46	-	M33x1,5	1.67ø	1.18	.591	.51	-	-	M10x1,5	.18	1.50	.51	-	-	1.98	0.9
<b>WSC-112</b>	2500	3.38	3.00	2.56	-	M42x1,5	2.25 ø	1.50	.629	.49	-	-	M10x1,5	.18	2.00	.73	-	-	1.70	2.0
<b>WSC-222</b>	5000	3.98	3.51	3.00	-	M60x1,5	3.00 ø	2.25	1.496	1.00	-	-	M20x2,5	.24	2.75	.92	-	-	2.12	4.0

\* This product is made to order. Please contact Enerpac for delivery information before specifying in your design.  
 \*\* Note: Dimension N is factory set. May change on types 221, 331 and 441 due to adjusted contact spring force.  
 Note: For manifold mounting dimensions (L)50.

# Mounting dimensions *for work supports*

Shown: WFL-221 holding a casting in place.



Foto B

## Mounting work supports

Enerpac work supports are offered in a wide variety of mounting styles. Dimensions for fixture holes and cavity preparation are specified for each mounting style separately.

■ The combination of Enerpac swing cylinders and work supports guarantee clamping without deformation.

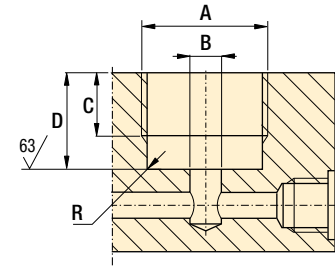


30007\_5

## Manifold work support mounting dimensions

Eliminates the need for fittings and tubing on the fixture. Use a flange nut to secure your manifold work support.

WFM/WSM



## Product dimensions in inches [ $\text{mm}$ ]

Model number	A	B	C	D	R	Manifold O-ring <sup>1)</sup>	Flange nut
--------------	---	---	---	---	---	-------------------------------	------------

▼ For manifold mount work supports

WFM-71	1.250-16 UN 2B	.37-.39	.58-.60	.93-.95	.015	ARP-017	FN-301
WSM-71	1.250-16 UN 2B	.37-.39	.58-.60	.93-.95	.015	ARP-017	FN-301

<sup>1)</sup> Polyurethane 92 duro.

## Threaded work support mounting dimensions

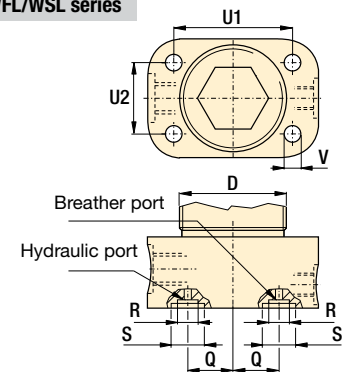
Threaded body work supports can be mounted directly into a fixture. The thread size (D) can be found in the dimension charts on  $\square 47$  (WFT) and  $\square 49$  (WST models). Use a flange nut to secure your threaded work support in the required position.

## Lower flange work support mounting dimensions

Lower flange work supports can be bolted straight onto a fixture, or can be mounted into a fixture. Flange nuts can be used to secure the cylinders at the required height.

**Note:** It is critical to keep breather port open to clean dry location.

WFL/WSL series



## Product dimensions in inches [ $\text{mm}$ ]

Model numbers	D	Q	R	S	U1	U2	V	Manifold O-ring <sup>1)</sup>	Flange nut
---------------	---	---	---	---	----	----	---	-------------------------------	------------

▼ For lower flange work supports

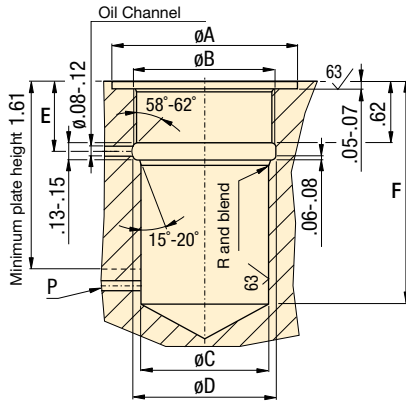
WFL-111	1.375-18UNEF	.57	.23	.37	1.62	.94	.284	ARP-010	FN-351
WFL-221	2.625-20UN	1.08	.34	.56	2.18	2.18	.284	ARP-110	—
WFL-331	2.88	1.20	.34	.56	2.44	2.44	.284	ARP-110	—
WFL-441	3.38	1.44	.34	.56	2.94	2.94	.284	ARP-110	—
WSL-111	1.375-18UNEF	.57	.23	.34	1.62	.94	.284	ARP-010	FN-351
WSL-221	2.625-20UN	1.08	.34	.56	2.18	2.18	.284	ARP-110	—
WSL-331	2.88	1.20	.34	.56	2.44	2.44	.284	ARP-110	—
WSL-441	3.38	1.44	.34	.56	2.94	2.94	.284	ARP-110	—

<sup>1)</sup> Polyurethane 92 duro.

**Cartridge work support** mounting dimensions

Can be designed onto narrow fixture plates as thru-hole mounting is fully functional.

**WFC/WSC**



**Dimensions** in inches [ ]

Model numbers	A	B	C	D	E	F	Ventilation below force required	
	mm						min.	
<b>▼ Hydraulic advance</b>								
<b>WFC-72</b>	1.68-1.70	M33x1,5	1.182-1.184	1.31-1.33	.62-.68	2.08	No	
<b>WFC-112</b>	2.26-2.28	M42x1,5	1.499-1.501	1.67-1.69	.69-.75	2.46	Yes	
<b>WFC-222</b>	3.01-3.03	M60x1,5	2.249-2.251	2.38-2.40	.69-.72	2.80	Yes	
<b>▼ Spring advance</b>								
<b>WSC-72</b>	1.68-1.70	M33x1,5	1.182-1.184	1.31-1.33	.62-.68	2.08	No	
<b>WSC-112</b>	2.26-2.28	M42x1,5	1.499-1.501	1.67-1.69	.69-.75	1.80	Yes	
<b>WSC-222</b>	3.01-3.03	M60x1,5	2.249-2.251	2.38-2.40	.69-.72	2.20	Yes	

Note: Ventilation required on WFC-112, 222 below 1.61 inch when mounted in blind cavity.

- Force: 1650 - 10,000 lbs
- Stroke: .36 - .66 inch
- Pressure: 700 - 5000 psi

- E** Cilindros de soporte
- F** Vérin anti-vibreur
- D** Abstützzylinder

**Options**

- Accessories** 86 ▶
- In-line filters** 193 ▶
- Fittings** 194 ▶
- Swing cylinders** 22 ▶

**Important**

**WARNING!**  
Support force and clamping force must be matched. Support force should be at least 150% of clamping force.

Do not exceed maximum flow rates to avoid premature lockup.

Always center load over work support.

# Linear cylinders

## Linear Cylinders

A wide variety of styles and features make Enerpac's linear cylinder line the most complete in the industry. Ranging from compact short stroke spring return cylinders to heavy-duty industrial grade double-acting automation cylinders, Enerpac has the cylinder to meet every application need. Whether you have to push it, pull it, clamp it, punch it, stamp it, press it, or hold it in place for days at a time, Enerpac has the cylinder to meet your need.

















## Technical support

Refer to the "Yellow Pages" of this catalog for:

- Safety instructions
- Basic hydraulic information
- Advanced hydraulic technology
- FMS (Flexible Machining Systems) technology
- Conversion charts and hydraulic symbols

 197 ▶



	▼ series	▼ page	
Link clamp / Link clamp arms	LU LCA	54 - 55 56 - 57	
<b>Pull cylinder range overview</b>		<b>58 - 59</b>	
Upper flange pull cylinders	PU	60 - 61	
Lower flange pull cylinders	PL	62 - 63	
Threaded body pull cylinders	PT	64 - 65	
<b>Linear cylinders</b>		<b>66 - 93</b>	
Threaded cylinders	CST, CDT	66 - 67	
Additional threaded cylinders	CYDA, WMT, WRT	68 - 69	
Manifold cylinders	CSM	70 - 71	
Block cylinders	CSB CDB	72 - 75	
Pull down clamps	ECH, ECM	76 - 77	
Hollow plunger cylinders	CY, HCS, QDH, RWH	78 - 79	
Positive clamping cylinders	MRS	80 - 81	
Single-acting universal cylinders	RW, MRW, REB, REP	82 - 83	
Double-acting universal cylinders	RD, AD	84 - 85	
Cylinder accessories		86 - 87	
Tie rod cylinder	TR	88 - 92	
Tie rod accessories	TR	93	

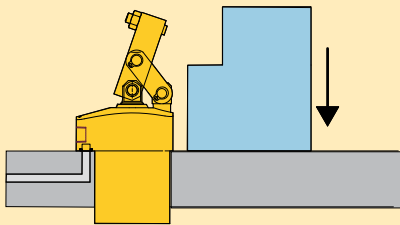
# Link clamp *Application & selection*

Shown: LUCS-31

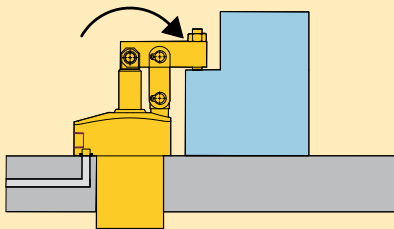


**▶ Link clamp allows unobstructed part loading and high clamping forces. The hydraulic cylinders extend to provide clamping force, and retract to allow part removal.**

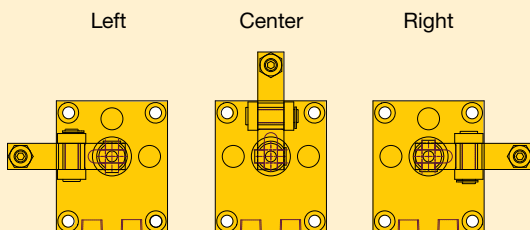
Arm completely retracts to allow part loading.



As cylinder extends, arm pivots to clamp part in place.



Arm location is changed easily without the use of tools.



## Quick and accurate clamping action

- Hydraulic cylinder pushes linkage, pivoting clamp arm into position
- Design ensures repeatable clamping location
- Linkage can be re-positioned to clamp at 90, 180, or 270 degrees from ports
- Clamps can be mounted using supplied bolts or held in place with flange nut
- Standard arm or long arm ordered separately

## Product selection

Clamping force <sup>1)</sup>	Stroke	Model number	Cylinder effective area	Oil capacity	Standard clamp arm (Sold separately)	Long clamp arm (Sold separately)
<b>▼ Single acting</b>						
675	0.73	<b>LUCS-31</b>	0.19	0.14	<b>LCAS-32</b>	<b>LCAL-32</b>
1750	0.92	<b>LUCS-81</b>	0.48	0.44	<b>LCAS-82</b>	<b>LCAL-82</b>
2650	1.17	<b>LUCS-121</b>	0.64	0.77	<b>LCAS-122</b>	<b>LCAL-122</b>
4200	1.36	<b>LUCS-191</b>	0.99	1.38	<b>LCAS-192</b>	<b>LCAL-192</b>
6100	1.76	<b>LUCS-281*</b>	1.49	2.76	<b>LCAS-282</b>	<b>LCAL-282</b>
<b>▼ Double acting</b>						
700	0.73	<b>LUCD-31</b>	0.19	0.14	<b>LCAS-32</b>	<b>LCAL-32</b>
1800	0.92	<b>LUCD-81</b>	0.48	0.44	<b>LCAS-82</b>	<b>LCAL-82</b>
2700	1.17	<b>LUCD-121</b>	0.64	0.77	<b>LCAS-122</b>	<b>LCAL-122</b>
4300	1.36	<b>LUCD-191</b>	0.99	1.38	<b>LCAS-192</b>	<b>LCAL-192</b>
6300	1.76	<b>LUCD-281*</b>	1.49	2.76	<b>LCAS-282</b>	<b>LCAL-282</b>

Contact Enerpac for models with metric threads and BSPP ports.

\* This product is made to order. Please contact Enerpac for delivery information before specifying in your design.

## Dimensions in inches [ ]

Model number	Port Size	C1	C2	C3	D	D1	D2	E
<b>▼ Single acting</b>								
<b>LUCS-31</b>	SAE#2	1.10	1.44	2.17	1.875-16UN	2.44	2.20	27.9°
<b>LUCS-81</b>	SAE#2	1.18	1.63	2.56	2.50-16UN	3.23	2.76	31.1°
<b>LUCS-121</b>	SAE#4	1.46	1.95	3.12	3.125-16 UN	4.02	3.46	28.5°
<b>LUCS-191</b>	SAE#4	1.57	2.30	3.66	3.50-16 UN	4.69	4.02	28.3°
<b>LUCS-281*</b>	SAE#4	1.97	2.60	4.36	4.125-16 UN	5.31	4.72	24.8°
<b>▼ Double acting</b>								
<b>LUCD-31</b>	SAE#2	1.10	1.44	2.17	1.875-16 UN	2.44	2.20	27.9°
<b>LUCD-81</b>	SAE#2	1.18	1.63	2.56	2.50-16 UN	3.23	2.76	31.1°
<b>LUCD-121</b>	SAE#4	1.46	1.95	3.12	3.125-16 UN	4.02	3.46	28.5°
<b>LUCD-191</b>	SAE#4	1.57	2.30	3.66	3.50-16 UN	4.69	4.02	28.3°
<b>LUCD-281*</b>	SAE#4	1.97	2.60	4.36	4.125-16 UN	5.31	4.72	24.8°

Contact Enerpac for models with metric threads and BSPP ports.

\* This product is made to order. Please contact Enerpac for delivery information before specifying in your design.

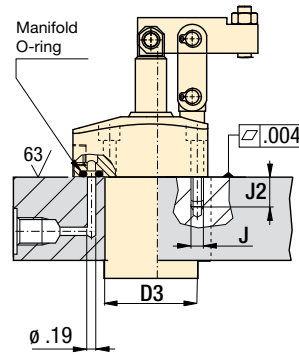
Collet-Lok® product line  
Swing clamps  
Work supports  
Linear clamps

**Installation dimensions** in inches

Clamp <sup>1)</sup> force lbs	Fixture hole Ø D3	Mounting thread J UNF	Min. depth J2	Manifold O-ring <sup>2)</sup> ARP No. or Inside Ø x thickness
700	1.885	.250-28	0.65	-010
1800	2.510	.312-24	0.75	-010
2700	3.135	.312-24	0.75	-010
4300	3.515	.375-24	0.88	-010
6300	4.140	.500-20	0.94	-010

<sup>1)</sup> With standard clamp arm.  
<sup>2)</sup> Polyurethane, 92 Durometer

**Note:** Mounting bolts and O-rings included.

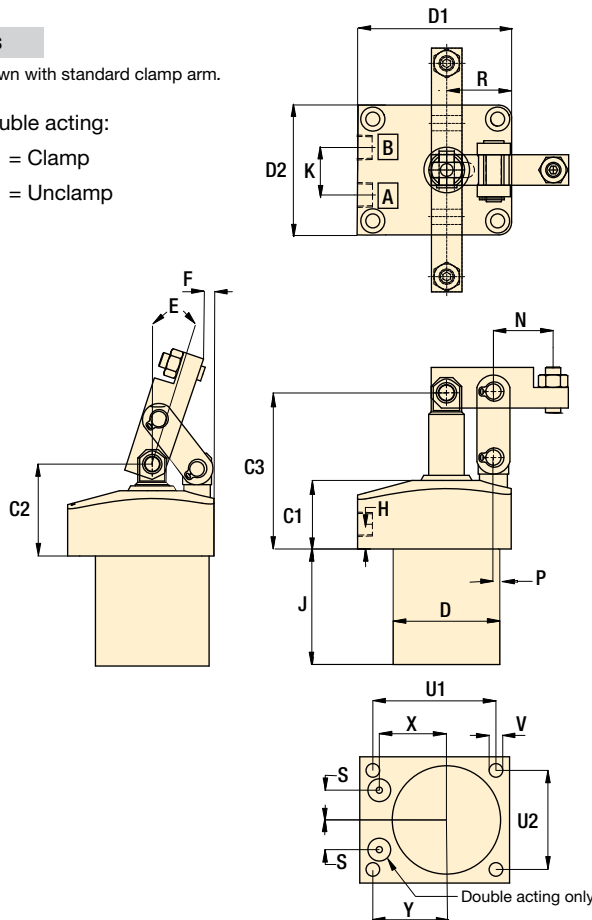


**all models**

Dimensions shown with standard clamp arm.

Double acting:

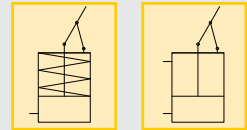
- A** = Clamp
- B** = Unclamp



	F	H	J	K	N	P	R	S	U1	U2	V Ø	X	Y	 lbs
<b>Single acting ▼</b>														
	0.04	0.43	1.85	-	0.93	0.33	1.10	0.411	2.05	1.81	0.26	1.128	1.14	2.7
	0.02	0.43	2.48	-	1.25	0.35	1.38	0.552	2.68	2.20	0.32	1.517	1.57	5.5
	0.03	0.47	2.80	-	1.48	0.47	1.73	0.633	3.46	2.91	0.32	1.739	2.01	10.0
	0.03	0.59	3.46	-	1.63	0.59	2.01	0.714	3.98	3.23	0.41	1.961	2.32	15.2
	0.08	0.79	3.90	-	2.01	0.63	2.36	0.821	4.53	3.94	0.51	2.257	2.56	25.9
<b>Double acting ▼</b>														
	0.04	0.43	1.85	0.79	0.93	0.33	1.10	0.849	2.05	1.81	0.26	0.807	1.14	2.7
	0.02	0.43	2.48	0.94	1.25	0.35	1.38	1.000	2.68	2.20	0.32	1.191	1.57	5.5
	0.03	0.47	2.80	1.18	1.48	0.47	1.73	1.039	3.46	2.91	0.32	1.484	2.01	10.0
	0.03	0.59	3.46	-	1.63	0.59	2.01	1.112	3.98	3.23	0.41	1.926	2.32	15.2
	0.08	0.79	3.90	1.50	2.01	0.63	2.36	1.181	4.53	3.94	0.51	2.046	2.56	25.9

- Clamp force: 675-6300 lbs**
- Stroke: 0.73-1.76 inch**
- Pressure: 500-5000 psi**

- E** Cilindros Amarre de enlace
- F** Brida basculante
- D** Gelenkspanner



**Options**

**Clamp arms**

57 ▶

**Work supports**

43 ▶

**Important**

Single-acting cylinders use a regenerative circuit; oil is sent to both sides of the piston at the same time. This eliminates the breather port, reducing damage from coolant and contamination.

Clamp arm should be parallel to cylinder mounting surface within 3° to avoid damage to cylinder and linkage. Use the included set screw to adjust clamp arm alignment.

# Clamp arms *for link clamps*

Shown: LCAS-31

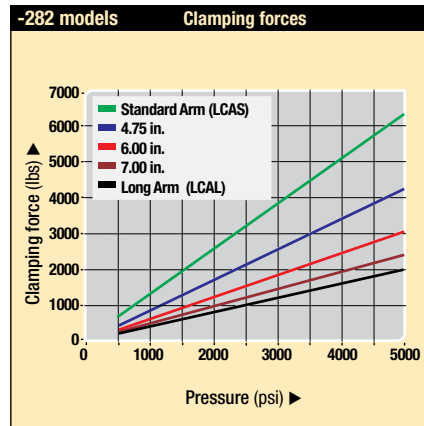
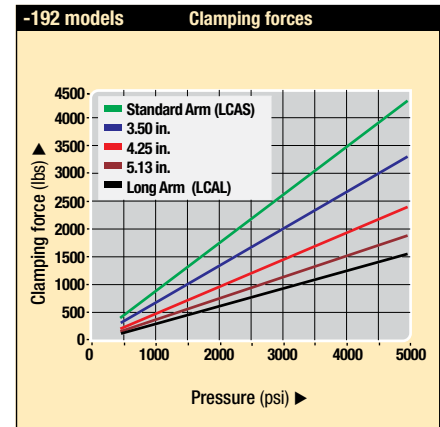
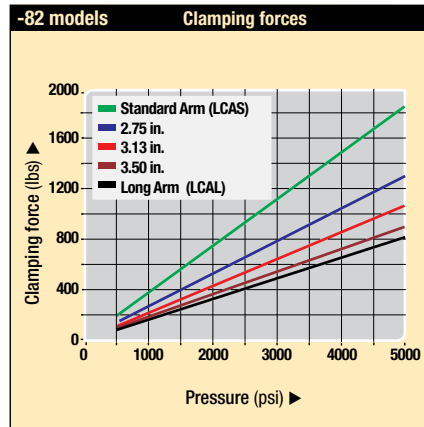
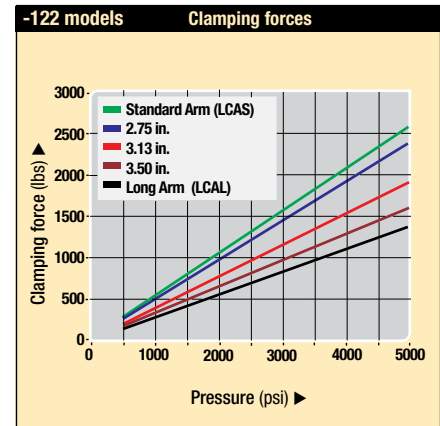
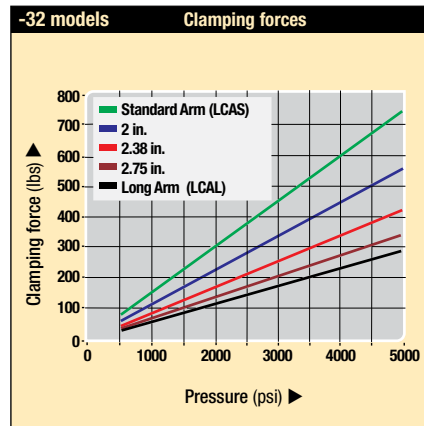


## Standard or custom built

- Available from Enerpac in standard or extended length
- Standard arm includes set screw and lock nut
- Long arm is machinable
- Make your own custom arm to suit specific applications

## Pressure vs clamping force

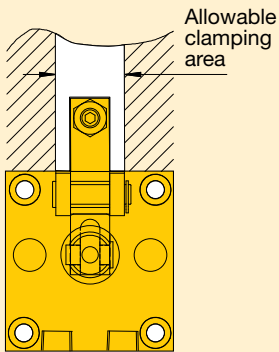
Different length clamp arms will determine the amount of clamping force transferred to the workpiece. As the length increases, the clamping force decreases.



Standard arms are readily available from Enerpac to meet most applications. In applications that require a custom designed arm, the machining information is supplied on page 57.

### Important

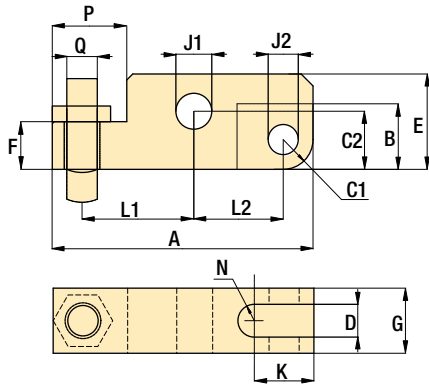
Clamp point must be within the boundaries of the anchor links on the clamp. Clamping outside of this area will cause damage to the linkage, leading to premature failure.



Collet-Lok® product line  
Swing clamps  
Work supports  
Linear clamps



**LCAS models** Standard Arm

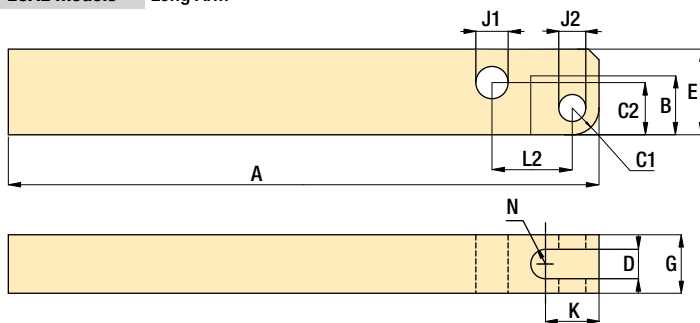


**Dimensions** in inches [ ]

Clamp capacity lbs	Model number	A	B	C1	C2	D	E	F	G
<b>▼ Standard clamp arms</b>									
700	<b>LCAS-32</b>	2.13	0.51	0.24	0.37	0.24	0.63	0.31	0.47
1800	<b>LCAS-82</b>	2.93	0.69	0.31	0.61	0.39	0.98	0.51	0.74
2700	<b>LCAS-122</b>	3.44	0.87	0.39	0.77	0.43	1.26	0.63	0.86
4300	<b>LCAS-192</b>	4.04	1.02	0.43	0.94	0.51	1.50	0.87	0.98
6300	<b>LCAS-282</b>	4.92	1.20	0.51	1.14	0.63	1.77	1.06	1.25

Clamp capacity lbs	Model number	J1	J2	K	L1	L2	N	P	Q
mm									
<b>▼ Standard clamp arms</b>									
700	<b>LCAS-32</b>	0.237-0.239	0.237-0.239	0.51	0.93	0.73	0.12	0.51	M6 x 1,0
1800	<b>LCAS-82</b>	0.396-0.398	0.317-0.319	0.63	1.26	0.96	0.20	0.87	M10 x 1,5
2700	<b>LCAS-122</b>	0.474-0.476	0.396-0.398	0.79	1.48	1.18	0.22	0.98	M12 x 1,75
4300	<b>LCAS-192</b>	0.593-0.595	0.474-0.476	0.94	1.63	1.42	0.26	1.22	M16 x 2,0
6300	<b>LCAS-282</b>	0.711-0.713	0.593-0.595	1.10	2.01	1.73	0.31	1.50	M20 x 2,5

**LCAL models** Long Arm



**NOTE:** Custom arms should be manufactured using this print. Make sure to follow all precautions listed.

**Dimensions** in inches [ ]

Clamp capacity lbs	Model number	A	B	C1	C2	D	E	G	J1	J2	K	L2	N
<b>▼ Long clamp arms</b>													
800	<b>LCAL-32</b>	3.35	0.51	0.24	0.37	0.24	0.63	0.47	0.237-0.239	0.237-0.239	0.51	0.73	0.12
1800	<b>LCAL-82</b>	4.13	0.69	0.31	0.61	0.39	0.98	0.74	0.396-0.398	0.317-0.319	0.63	0.96	0.20
2700	<b>LCAL-122</b>	4.33	0.87	0.39	0.77	0.43	1.26	0.86	0.474-0.476	0.396-0.398	0.79	1.18	0.22
4300	<b>LCAL-192</b>	6.30	1.02	0.43	0.94	0.51	1.50	0.98	0.593-0.595	0.474-0.476	0.94	1.42	0.26
6300	<b>LCAL-282</b>	8.66	1.20	0.51	1.14	0.63	1.77	1.25	0.711-0.713	0.593-0.595	1.10	1.73	0.31

**Force: 700-6300 lbs**

**Pressure: 500-5000 psi**

- E** Brazos de amarre
- F** Bras de bridage
- D** Spannarme

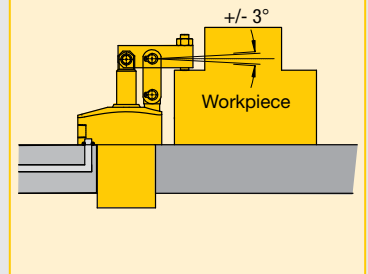
**Options**

**Work supports** [43 ▶](#)

**Accessories** [86 ▶](#)

**Important**

**Clamp arm should be parallel to cylinder mounting surface within 3° to avoid damage to cylinder and linkage. Use the included set screw to adjust clamp arm alignment.**



Shown: PLSS-121, PUSD-121



▶ Hydraulic pull cylinders utilize hydraulic pressure to hold down parts in a fixture. The guided plunger maintains orientation during the full clamping cycle, eliminating the need for an external guide. Internally threaded plunger ends accept various custom attachments to assist in the clamping process.

Enerpac offers both single- and double-acting pull cylinders, with capacities ranging from 1250 to 9600 lbs. for pulling and 2950 to 18,400 lbs. for pushing applications.

■ Hydraulic fixture with pull and swing cylinders, manifold and threaded cylinders for positioning and holding the work piece during milling process of gun breeches.



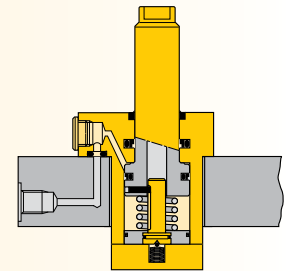
## Compact and full featured design

- Guided linear plunger movement
- Compact design allows for efficient fixture layout
- Variety of mounting styles to meet design needs
- Internal plunger thread and flats across plunger top allow easy mounting of attachments
- Choice of porting styles to meet system and design requirements
- Single- and double-acting cylinders to suit a variety of hydraulic requirements

## i Select your pull cylinder type:

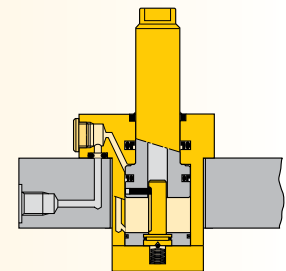
### Single acting

- The obvious choice when there are few system restrictions, and there are not many units retracting simultaneously
- Valving and plumbing is less complex



### Double acting

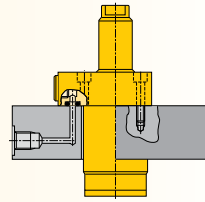
- When greater control is required during the unclamp cycle
- When heavy attachments are being used
- When timing sequences are critical: less sensitive to system back pressures resulting from long tube lengths or numerous components being retracted at the same time



## **i** Select your mounting method:

### **PU series, Upper flange mounting**

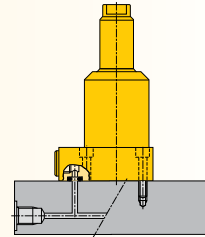
- Flexible design allows for manifold or threaded oil port connection
- Fixture hole does not require tight tolerances
- Easy installation with only 3 or 4 mounting bolts



60 ▶

### **PL series, Lower flange mounting**

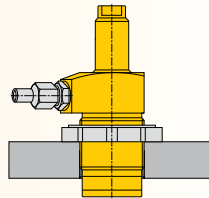
- Flexible design allows for manifold or threaded port connection
- No fixture hole required
- Easy installation with only 3 or 4 mounting bolts



62 ▶

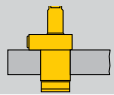


### **PT series, Threaded body mounting**

- Body thread for precise cylinder height positioning
- Threaded oil port connection
- Can be threaded directly into the fixture and secured in position by means of standard flange nuts



64 ▶

## **globe** Product selection

Cylinder capacity		Stroke	Upper flange	Lower flange	Threaded body
lbs	lbs	in			
Pull	Push				
<b>▼ Single acting</b>					
Model number					
1250	-	.89	<b>PUSS-51</b>	<b>PLSS-51</b>	<b>PTSS-51</b>
2950	-	1.10	<b>PUSS-121</b>	<b>PLSS-121</b>	<b>PTSS-121</b>
<b>▼ Double acting</b>					
Model number					
1400	2950	.89	<b>PUSD-51</b>	<b>PLSD-51</b>	<b>PTSD-51</b>
2475	6300	.87	<b>PUSD-92</b>	<b>PLSD-92</b>	<b>PTSD-92</b>
3150	6150	1.10	<b>PUSD-121</b>	<b>PLSD-121</b>	<b>PTSD-121</b>
9600	18,400	1.20	<b>PUSD-351</b>	<b>PLSD-351</b>	<b>PTSD-351</b>

**Note:** - Call Enerpac to order models with metric thread and BSPP port connections.  
- Pull forces for single-acting cylinders reduced due to spring force.

[www.enerpacwh.com](http://www.enerpacwh.com)

**Pull force: 1250-9600 lbs**

**Push force: 2950-18,400 lbs**

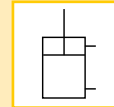
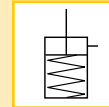
**Stroke: 0.87-1.20 inch**

**Pressure: 500-5000 psi**

**E** Cilindros de tracción

**F** Verins traction

**D** Zugzylinder



## **lightbulb** Options

### Accessories

86 ▶



### Collet-Lok® push cylinders

18 ▶



### Work supports

43 ▶



### Swing cylinders

22 ▶



### Sequence valves

152 ▶



# Pull cylinders - Upper flange models

Shown: PUSS-51, PUSD-121

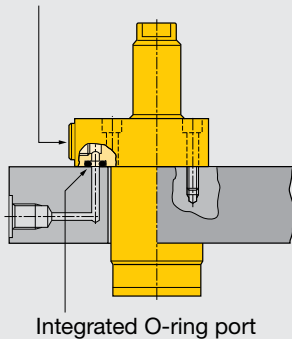


## PU series

Upper flange pull cylinders are designed for integrated manifold mounting solutions.

Hydraulic connections are made through SAE or BSPP oil connection or the standard integrated O-ring ports.

Oil connection



Integrated O-ring port

■ Enerpac upper flange pull cylinders in a fixture for gun breech production.



## Minimal mounting height

...when space is at a premium

- Guided linear plunger movement
- Flexible design allows for manifold or threaded port connection
- Low profile mounting style allows body to be below mounting surface
- Internal plunger thread allows easy mounting of attachments
- Simple mounting preparation
- Easy to machine fixture hole: does not require tight tolerances
- Easy assembly: 3 or 4 mounting bolts
- Double oil connection: threaded port or manifold mount

## Product selection

Cylinder capacity		Stroke	Model number	Cylinder effective area		Oil capacity	
lbs Pull	lbs Push	in		in <sup>2</sup> Pull	in <sup>2</sup> Push	in <sup>3</sup> Pull	in <sup>3</sup> Push
<b>▼ Single acting</b>							
1250	–	.89	<b>PUSS-51</b>	.28	–	.25	–
2950	–	1.10	<b>PUSS-121</b>	.63	–	.70	–
<b>▼ Double acting</b>							
1400	2950	.89	<b>PUSD-51</b>	.28	.59	.25	.53
2475	6300	.87	<b>PUSD-92</b>	.49	1.25	.42	1.08
3150	6150	1.10	<b>PUSD-121</b>	.63	1.23	.70	1.40
9600	18,400	1.20	<b>PUSD-351</b>	1.92	3.68	2.27	4.35

**Note:** - Call Enerpac to order models with BSPP oil connections.  
- Pull forces for single-acting cylinders reduced due to spring force.

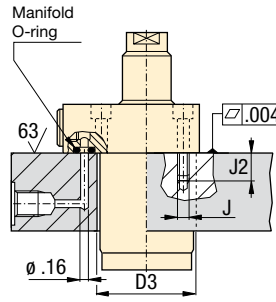
## Dimensions in inches [ ]

Model number	A	B	C1	D	D1	D2	E	E1	F	H
				∅			∅	∅		
<b>▼ Single acting</b>										
<b>PUSS-51</b>	5.07	4.18	0.98	1.37	2.13	2.25	0.63	0.59	0.51	0.55
<b>PUSS-121</b>	6.31	5.21	1.00	1.87	2.62	2.88	0.87	0.82	0.68	0.61
<b>▼ Double acting</b>										
<b>PUSD-51</b>	5.07	4.18	0.98	1.37	2.13	2.25	0.63	0.59	0.51	0.55
<b>PUSD-92</b>	5.43	4.57	0.98	1.88	2.76	2.13	0.98	0.93	0.70	0.49
<b>PUSD-121</b>	6.31	5.21	1.00	1.87	2.62	2.88	0.87	0.82	0.68	0.61
<b>PUSD-351</b>	8.04	6.83	0.98	3.14	3.94	3.50	1.50	1.42	1.13	0.49

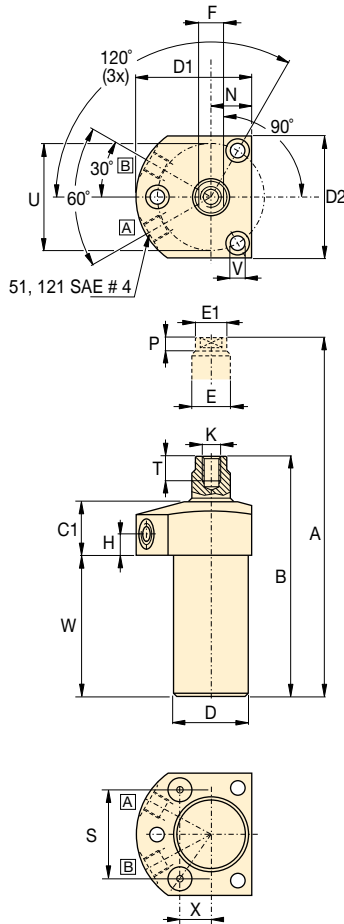
**Installation dimensions in inches**

Pull force lbs	Fixture hole Ø D3	Mounting thread J UNF	Min. depth J2	Manifold O-ring <sup>1)</sup> ARP numbers or Inside Ø x thickness
1400	1.39	.250-28	.65	568-011
2475	1.93	M6	.59	.17 x .139
3150	1.89	.312-24	.80	568-011
9600	3.06	.375-24	.74	.17 x .139

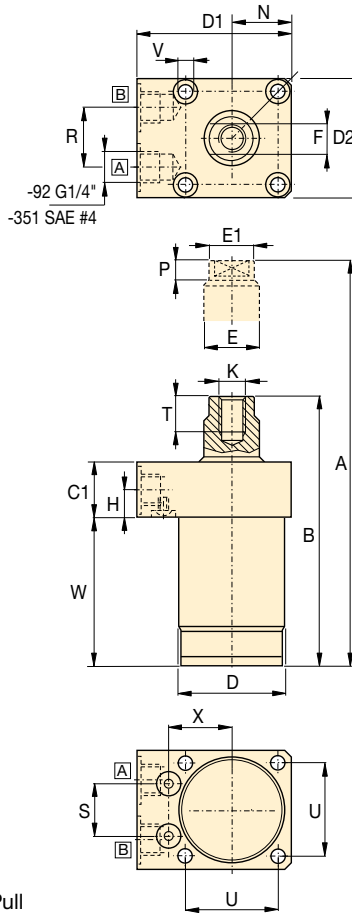
<sup>1)</sup> O-ring material: polyurethane, 92 Durometer



**-51, 121**

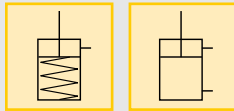


**-92, 351**



- Pull force: 1250-9600 lbs**
- Push force: 2950-18,400 lbs**
- Stroke: .87-1.20 inch**
- Pressure: 500-5000 psi**

- E Cilindros de tracción**
- F Verins traction**
- D Zugzylinder**



**Options**

**Accessories** 86 ▶

**Collet-Lok® push cylinders** 18 ▶

**Swing cylinders** 22 ▶

**Sequence valves** 152 ▶

**Important**

Single-acting cylinders can be vented through the manifold port.

The upper flange pull cylinder has a bolt pattern which is identical to its lower flange equivalent, enabling interchangeability.

In case there is a risk of machining coolants and debris being inhaled via the breather vent, it is recommended to pipe this port to an area outside the fixture that is protected from machining coolants and debris.

	K	N	P	R	S	T	U	V	W	X	lbs	Model number
								Ø				
												<b>Single acting ▼</b>
	.312-24 UNF	0.75	0.23	-	1.614	0.62	1.97	0.27	2.60	0.565	2.5	<b>PUSS-51</b>
	.500-20 UNF	0.99	0.37	-	2.048	0.75	2.50	0.35	3.38	0.717	3.5	<b>PUSS-121</b>
												<b>Double acting ▼</b>
	.312-24 UNF	0.75	0.23	-	1.614	0.62	1.97	0.27	2.60	0.565	2.5	<b>PUSD-51</b>
	M10 x 1.50	1.04	0.41	1.02	0.934	0.63	1.65	0.26	2.99	1.128	4.4	<b>PUSD-92</b>
	.500-20 UNF	0.99	0.37	-	2.048	0.75	2.50	0.35	3.38	0.717	3.5	<b>PUSD-121</b>
	M16 x 2.00	1.71	0.51	1.02	1.356	1.22	2.76	0.43	3.80	1.637	12.3	<b>PUSD-351</b>

# Pull cylinders - Lower flange models

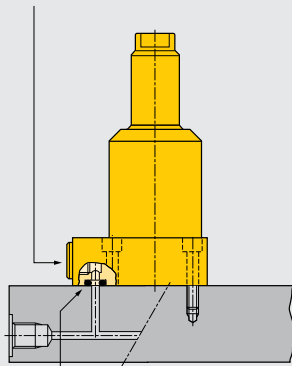
Shown: PLSS-51, PLSS-121



## PL series

The lower flange cylinders are designed for integrated manifold mounting solutions. Hydraulic connections are made through SAE or BSPP oil connection or the standard integrated O-ring ports.

Oil connection



Integrated O-ring port

## Minimal mounting height

...when space is at a premium

- Guided linear plunger movement
- Flexible design allows for manifold or threaded port connection
- Low profile mounting style allows body to be below mounting surface
- Internal plunger thread allows easy mounting of attachments
- Easiest mounting preparation in the line
- Easy to machine fixture hole: does not require tight tolerances
- Easy assembly: 3 or 4 mounting bolts
- Double oil connection: threaded port or manifold mount

## Product selection

Cylinder capacity		Stroke	Model number	Cylinder effective area		Oil capacity	
lbs Pull	Push	in		in <sup>2</sup> Pull	Push	in <sup>3</sup> Pull	Push
<b>▼ Single acting</b>							
1250	–	.89	<b>PLSS-51</b>	.28	–	.25	–
2950	–	1.10	<b>PLSS-121</b>	.63	–	.70	–
<b>▼ Double acting</b>							
1400	2950	.89	<b>PLSD-51</b>	.28	.59	.25	.53
2475	6300	.87	<b>PLSD-92</b>	.49	1.25	.42	1.08
3150	6150	1.10	<b>PLSD-121</b>	.63	1.23	.70	1.40
9600	18,400	1.20	<b>PLSD-351</b>	1.92	3.68	2.27	4.35

**Note:** - Call Enerpac to order models with BSPP oil connections.  
- Pull forces for single-acting cylinders reduced due to spring force.

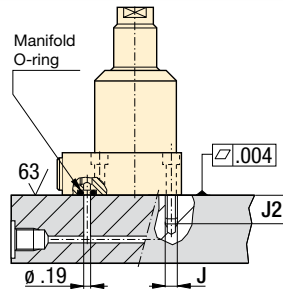
## Dimensions in inches [ ]

Model number	A	B	C1	D	D1	D2	E	E1	F	H
				∅			∅	∅		
<b>▼ Single acting</b>										
<b>PLSS-51</b>	5.07	4.18	0.98	1.37	2.13	2.25	0.63	0.59	0.51	0.55
<b>PLSS-121</b>	6.31	5.21	1.00	1.87	2.62	2.88	0.87	0.82	0.68	0.61
<b>▼ Double acting</b>										
<b>PLSD-51</b>	5.07	4.18	0.98	1.37	2.13	2.25	0.63	0.59	0.51	0.55
<b>PLSD-92</b>	5.43	4.57	0.98	1.88	2.76	2.13	0.98	0.93	0.7	0.49
<b>PLSD-121</b>	6.31	5.21	1	1.87	2.62	2.88	0.87	0.82	0.68	0.61
<b>PLSD-351</b>	8.04	6.83	0.98	3.14	3.94	3.5	1.5	1.42	1.13	0.49

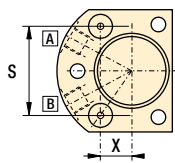
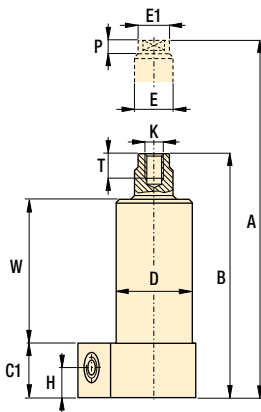
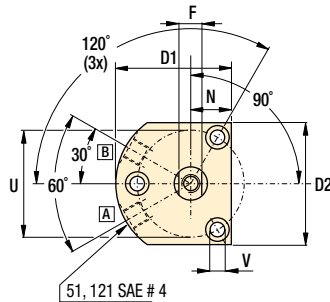
**Installation dimensions** in inches

Pull force lbs	Mounting thread J UNF	Minimum depth J2	Manifold O-ring <sup>1)</sup> ARP numbers or inside Ø x thickness
1400	.250-28	.65	568-011
2475	M6	.59	.17 x .139
3150	.312-24	.80	568-011
9600	.375-24	.74	.17 x .139

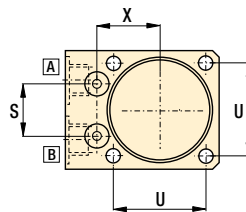
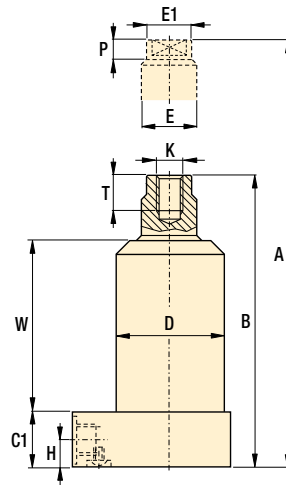
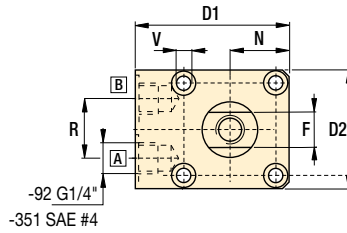
<sup>1)</sup> O-ring material: polyurethane, 92 Durometer



**-51, -121**



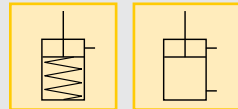
**-92, -351**




[A] = Pull  
[B] = Push (venting)


- Pull force: 1250-9600 lbs**
- Push force: 2950-18,400 lbs**
- Stroke: .86-1.20 inch**
- Pressure: 500-5000 psi**


- E Cilindros de tracción**
- F Verins traction**
- D Zugzylinder**




**Options**

**Accessories**  86 ▶

**Collet-Lok® push cylinders**  18 ▶

**Swing cylinders**  22 ▶

**Sequence valves**  152 ▶

**Important**

Single-acting cylinders can be vented through the manifold port.

The lower flange pull cylinder has a bolt pattern which is identical to its upper flange equivalent, enabling interchangeability.

In case there is a risk of machining coolants and debris being inhaled via the breather vent, it is recommended to pipe this port to an area outside the fixture that is protected from machining coolants and debris.

	K	N	P	R	S	T	U	V	W	X	Model number	
											lbs	
<b>Single acting ▼</b>												
	.312-24 UNF	0.75	0.23	-	1.614	0.62	1.97	0.27	2.60	0.565	2.5	<b>PLSS-51</b>
	.500-20 UNF	0.99	0.37	-	2.048	0.75	2.50	0.35	3.38	0.717	3.5	<b>PLSS-121</b>
<b>Double acting ▼</b>												
	.312-24 UNF	0.75	0.23	-	1.614	0.62	1.97	0.27	2.60	0.565	2.5	<b>PLSD-51</b>
	M10 x 1.50	1.04	0.41	1.02	0.934	0.63	1.65	0.26	2.99	1.128	4.4	<b>PLSD-92</b>
	.500-20 UNF	0.99	0.37	-	2.048	0.75	2.50	0.35	3.38	0.717	3.5	<b>PLSD-121</b>
	M16 X 2.00	1.71	0.51	1.02	1.356	1.22	2.76	0.43	3.80	1.637	12.3	<b>PLSD-351</b>

# Pull cylinders - Threaded body models

Shown: PTSS-51, PTSD-121

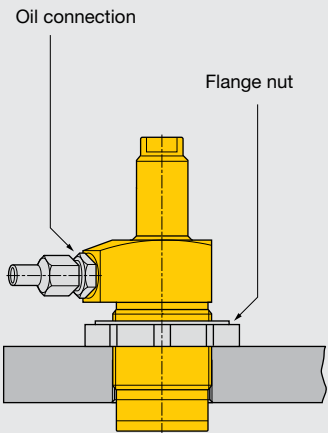


## PT-series

The threaded body pull cylinders can be bolted to the fixture.

This allows easy installation or removal of the unit and does not require machined fixture holes.

The cylinder is adjusted to the appropriate height, and then locked in place using a flange nut (□86).



■ Threaded body pull cylinder with modified clamp arm, mounted on a frame-straightening fixture.



## Threaded directly into the fixture

...can be secured at any height

- Guided linear plunger movement
- Threaded port connection
- Internal plunger thread allows easy mounting of attachments
- Simple mounting preparation
- Easy installation and removal
- Greatest flexibility in fixture design

## Product selection

Cylinder capacity		Stroke	Model number	Cylinder effective area		Oil capacity	
lbs Pull	Push	in		in <sup>2</sup> Pull	Push	in <sup>3</sup> Pull	Push
<b>▼ Single acting</b>							
1250	-	.89	<b>PTSS-51</b>	.28	-	.25	-
2950	-	1.10	<b>PTSS-121</b>	.63	-	.70	-
<b>▼ Double acting</b>							
1400	2950	.89	<b>PTSD-51</b>	.28	.59	.25	.53
2475	6300	.87	<b>PTSD-92</b>	.49	1.25	.42	1.08
3150	6150	1.10	<b>PTSD-121</b>	.63	1.23	.70	1.40
9600	18,400	1.20	<b>PTSD-351</b>	1.92	3.68	2.27	4.35

Note: - Call Enerpac to order models with BSPP oil connections.  
- Pull forces for single-acting cylinders reduced due to spring force.

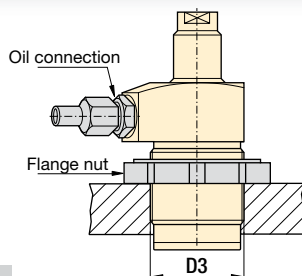
## Dimensions in inches [ ]

Model number	A	B	C1	D		D1	D2	E Ø
				Thread				
<b>▼ Single acting</b>								
<b>PTSS-51</b>	5.07	4.18	0.98	1.375-18 UNEF		1.88	1.49	0.63
<b>PTSS-121</b>	6.31	5.22	1.00	1.875-16 UN		2.38	2.00	0.87
<b>▼ Double acting</b>								
<b>PTSD-51</b>	5.07	4.18	0.98	1.375-18 UNEF		1.88	1.49	0.63
<b>PTSD-92</b>	5.12	4.25	1.19	M48 x 1,5		2.47	1.90	0.98
<b>PTSD-121</b>	6.31	5.22	1.00	1.875-16 UN		2.38	2.00	0.87
<b>PTSD-351</b>	7.72	6.52	1.26	3.125-16 UN		3.48	3.15	1.50



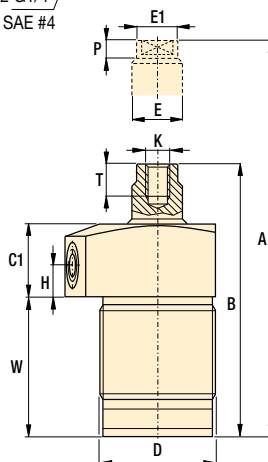
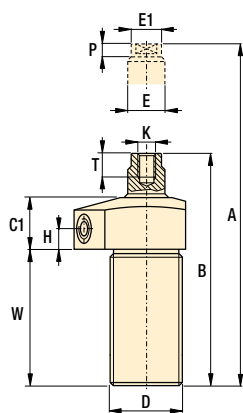
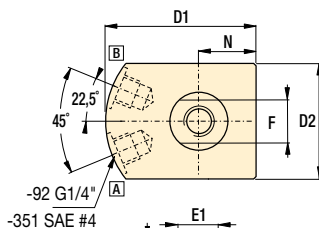
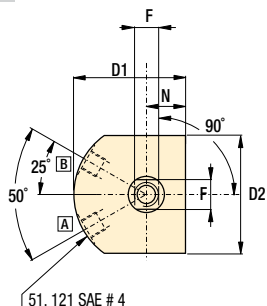
**Installation dimensions in inches**

Pull force lbs	Fixture hole thread size D3
1400	1.375-18 UNEF
2475	M48 x 1.5
3150	1.875-16 UNF
9600	3.125-16 UN



-51, 121

-92, -351



[A] = Pull  
[B] = Push (venting)

**Accessory chart**

Model number	Mounting flange Sold separately [87 ▶	Flange nut Sold separately [86 ▶	Yoke Sold separately
--------------	---------------------------------------------	----------------------------------------	-------------------------

▼ Single acting

PTSS-51	MF-351	FN-351	Y3121
PTSS-121	MF-481	FN-811	

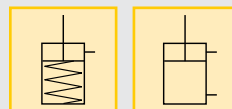
▼ Double acting

PTSD-51	MF-351	FN-351	Y3121
PTSD-92	MF-482	FN-482	
PTSD-121	MF-481	FN-481	
PTSD-351	MF-801	FN-801	

	E1	F	H	K	N	P	T	W	lbs	Model number
	∅									
	.59	.51	.38	.313-24 UNF	.75	.23	.62	2.60	2.5	<b>PTSS-51</b>
	.82	.68	.38	.500-20 UNF	1.00	.38	.75	3.38	3.5	<b>PTSS-121</b>
	.59	.51	.38	.313-24 UNF	.75	.23	.62	2.60	2.5	<b>PTSD-51</b>
	.93	.70	.51	M10 x 1.5	.95	.41	.63	2.47	4.4	<b>PTSD-92</b>
	.82	.68	.38	.500-20 UNF	1.00	.38	.75	3.38	3.5	<b>PTSD-121</b>
	1.42	1.13	.51	M16 x 2.0	1.57	.51	1.22	3.22	10.4	<b>PTSD-351</b>

- Pull force: 1250-9600 lbs**
- Push force: 2950-18,400 lbs**
- Stroke: .87-1.20 inch**
- Pressure: 500-5000 psi**

- E Cilindros de tracción**
- F Verins traction**
- D Zugzylinder**



**Options**

**Accessories** [86 ▶

**Collet-Lok® swing cylinders** [18 ▶

**Swing cylinders** [22 ▶

**Sequence valves** [152 ▶

**Important**

Single-acting cylinders can be vented through the manifold port.

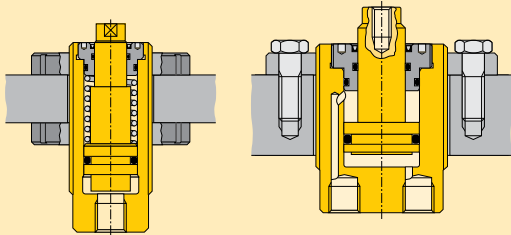
In case there is a risk of machining coolants and debris being inhaled via the breather vent, it is recommended to pipe this port to an area outside the fixture that is protected from machining coolants and debris.

# Threaded cylinders *Application & selection*

Shown: CST-9381, CST-571, CST-18251, CDT-18131, CDT-40251



▶ Threaded cylinders are designed for workpiece positioning, holding and ejecting applications where space is at a premium. Double-acting models are also suited to manufacturing applications, such as production punching.



## Accessory chart

Body thread D	Mounting flange Sold Separately 87 ▶	Flange nut Sold Separately 86 ▶	Plunger thread K	Contact bolt Sold Separately 86 ▶
0.500-20 UN	MF-121	FN-121	#6-32 UN	BS-21
0.750-16 UN	MF-201	FN-201	#8-32 UN	BS-41
1.000-12 UN	MF-251	FN-251	0.250-28 UN	BS-61
1.313-16 UN	MF-331	FN-331	0.313-24 UN	BS-81
1.625-16 UN	MF-421	FN-421	0.375-16 UN	BS-91
1.875-16 UN	MF-481	FN-481	0.500-13 UN	BS-101
2.125-16 UN	MF-551	FN-551		
2.500-16 UN	MF-651	FN-651		

■ Threaded cylinder, mounted with horizontal bracket to position the workpiece against the stops. Enerpac swing cylinders are then activated to clamp the work piece before machining operations begin.

## High clamping forces in a compact body

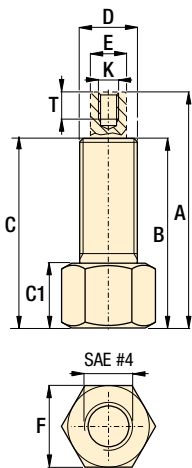
- Minimum cylinder diameter combined with maximized clamping forces
- Threaded body allows fine positioning and easy installation
- Internal plunger wipers allow maintenance-free, high-cycle performance
- Center-tapped plungers will hold workpiece contact buttons
- Single-acting models with spring return simplify hydraulic tubing requirements
- Double-acting models are recommended for high-cycle applications

## Product selection

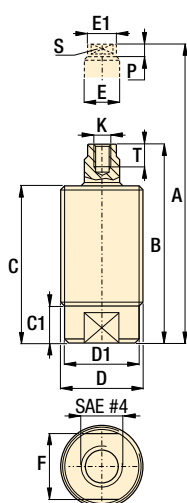
Cylinder capacity at 5000 psi lbs	Stroke in	Model number	Effective area in <sup>2</sup>		Oil capacity in <sup>3</sup>		
			push	pull	push	pull	
<b>▼ Single acting</b>							
380	–	0.24	<b>CST-271</b>	0.08	–	0.02	–
380	–	0.36	<b>CST-2101</b>	0.08	–	0.03	–
380	–	0.52	<b>CST-2131</b>	0.08	–	0.04	–
980	–	0.27	<b>CST-471</b>	0.20	–	0.05	–
980	–	0.50	<b>CST-4131</b>	0.20	–	0.10	–
980	–	0.76	<b>CST-4191</b>	0.20	–	0.15	–
980	–	0.98	<b>CST-4251</b>	0.20	–	0.19	–
980	–	1.49	<b>CST-4381</b>	0.20	–	0.29	–
1950	–	0.28	<b>CST-971</b>	0.39	–	0.11	–
1950	–	0.52	<b>CST-9131</b>	0.39	–	0.20	–
1950	–	0.76	<b>CST-9191</b>	0.39	–	0.29	–
1950	–	1.04	<b>CST-9251</b>	0.39	–	0.38	–
1950	–	1.52	<b>CST-9381</b>	0.39	–	0.58	–
3950	–	0.51	<b>CST-18131</b>	0.79	–	0.40	–
3950	–	0.98	<b>CST-18251</b>	0.79	–	0.78	–
3950	–	1.49	<b>CST-18381</b>	0.79	–	1.18	–
3950	–	1.97	<b>CST-18501</b>	0.79	–	1.56	–
6110	–	0.59	<b>CST-27151</b>	1.22	–	0.72	–
6110	–	0.98	<b>CST-27251</b>	1.22	–	1.20	–
6110	–	1.97	<b>CST-27501</b>	1.22	–	2.40	–
8800	–	0.58	<b>CST-40131</b>	1.76	–	0.90	–
8800	–	1.05	<b>CST-40251</b>	1.76	–	1.73	–
8800	–	1.56	<b>CST-40381</b>	1.76	–	2.63	–
8800	–	2.03	<b>CST-40501</b>	1.76	–	3.46	–
<b>▼ Double acting</b>							
3900	2330	0.51	<b>CDT-18131</b>	0.77	0.46	0.40	0.24
3900	2330	0.98	<b>CDT-18251</b>	0.77	0.46	0.78	0.46
3900	2330	1.50	<b>CDT-18381</b>	0.77	0.46	1.18	0.70
3900	2330	1.97	<b>CDT-18501</b>	0.77	0.46	1.52	0.91
6110	4080	0.57	<b>CDT-27151</b>	1.22	0.82	0.72	0.48
6110	4080	0.97	<b>CDT-27251</b>	1.22	0.82	1.20	0.81
6110	4080	1.96	<b>CDT-27501</b>	1.22	0.82	2.40	1.61
8800	5870	0.51	<b>CDT-40131</b>	1.76	1.17	0.90	0.60
8800	5870	0.99	<b>CDT-40251</b>	1.76	1.17	1.73	1.15
8800	5870	1.50	<b>CDT-40381</b>	1.76	1.17	2.63	1.75
8800	5870	1.97	<b>CDT-40501</b>	1.76	1.17	3.46	2.30

**Note:** - Seal material: Buna-N, Polyurethane.  
- Minimum operating pressure for single-acting models (to overcome return spring force) is 580 psi.

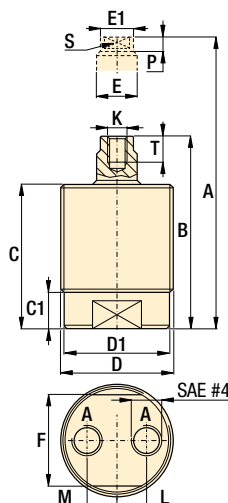
CST-271, -2101, -2131



Other CST models



CDT models



- Force: 380-8800 lbs
- Stroke: 0.24-2.03 inch
- Pressure: 580-5000 psi

- E** Cilindros roscados
- F** Vérins corps filetés
- D** Einschraubzylinder



Options

Accessories

86 ▶



Product dimensions in inches [ ]

Model number	A Ext. height	B Retr. height	C	C1	D ø	D1 ø	E ø	E1 ø	F	K thread	L Retr.	M Ext.	P	S	T	lbs
<b>▼ Single acting</b>																
CST-271	1.89	1.65	1.61	0.59	.500-20 UNF	-	0.19	-	0.63	#6-32 UNC	-	-	-	-	0.20	0.2
CST-2101	2.13	1.77	1.74	0.61	.500-20 UNF	-	0.19	-	0.63	#6-32 UNC	-	-	-	-	0.20	0.3
CST-2131	2.55	2.03	2.03	0.61	.500-20 UNF	-	0.19	-	0.63	#6-32 UNC	-	-	-	-	0.20	0.3
CST-471	2.14	1.87	1.71	0.37	.750-16 UNF	0.69	0.27	-	0.62	#8-32 UNC	-	-	0.16	0.25	0.28	0.4
CST-4131	2.71	2.21	2.05	0.37	.750-16 UNF	0.69	0.27	-	0.62	#8-32 UNC	-	-	0.16	0.25	0.28	0.3
CST-4191	3.38	2.62	2.46	0.37	.750-16 UNF	0.69	0.27	-	0.62	#8-32 UNC	-	-	0.16	0.25	0.28	0.4
CST-4251	3.95	2.97	2.81	0.37	.750-16 UNF	0.69	0.27	-	0.62	#8-32 UNC	-	-	0.16	0.25	0.28	0.5
CST-4381	5.76	4.27	4.11	0.37	.750-16 UNF	0.69	0.27	-	0.62	#8-32 UNC	-	-	0.16	0.25	0.28	0.7
CST-971	2.54	2.26	2.03	0.32	1.000-12 UNF	0.88	0.39	-	0.79	.250-28 UNF	-	-	0.15	0.32	0.39	0.6
CST-9131	3.02	2.50	2.28	0.32	1.000-12 UNF	0.88	0.39	-	0.79	.250-28 UNF	-	-	0.15	0.32	0.39	0.7
CST-9191	3.87	3.11	2.89	0.32	1.000-12 UNF	0.88	0.39	-	0.79	.250-28 UNF	-	-	0.15	0.32	0.39	0.8
CST-9251	4.46	3.42	3.21	0.32	1.000-12 UNF	0.88	0.39	-	0.79	.250-28 UNF	-	-	0.15	0.32	0.39	0.9
CST-9381	5.63	4.11	3.91	0.32	1.000-12 UNF	0.88	0.39	-	0.79	.250-28 UNF	-	-	0.15	0.32	0.39	1.0
CST-18131	3.26	2.75	2.50	0.49	1.313-16 UN	1.22	0.63	0.59	1.06	.313-24 UNF	-	-	0.26	0.50	0.47	1.2
CST-18251	4.50	3.52	3.27	0.49	1.313-16 UN	1.22	0.63	0.59	1.06	.313-24 UNF	-	-	0.26	0.50	0.47	1.3
CST-18381	5.76	4.27	4.02	0.49	1.313-16 UN	1.22	0.63	0.59	1.06	.313-24 UNF	-	-	0.26	0.50	0.47	1.5
CST-18501	6.87	4.90	4.65	0.49	1.313-16 UN	1.22	0.63	0.59	1.06	.313-24 UNF	-	-	0.26	0.50	0.47	1.7
CST-27151	3.46	2.87	2.62	0.54	1.625-16 UN	1.52	0.71	0.67	1.38	.375-16 UNC	-	-	0.26	0.57	0.47	1.4
CST-27251	4.66	3.68	3.43	0.54	1.625-16 UN	1.52	0.71	0.67	1.38	.375-16 UNC	-	-	0.26	0.57	0.47	2.0
CST-27501	7.71	5.74	5.49	0.54	1.625-16 UN	1.52	0.71	0.67	1.38	.375-16 UNC	-	-	0.26	0.57	0.47	2.9
CST-40131	3.52	2.94	2.70	0.43	1.875-16 UN	1.79	0.78	0.75	1.63	.500-13 UNC	-	-	0.31	0.67	0.47	2.2
CST-40251	4.78	3.73	3.48	0.43	1.875-16 UN	1.79	0.78	0.75	1.63	.500-13 UNC	-	-	0.31	0.67	0.47	2.6
CST-40381	6.49	4.93	4.69	0.43	1.875-16 UN	1.79	0.78	0.75	1.63	.500-13 UNC	-	-	0.31	0.67	0.47	3.3
CST-40501	7.44	5.41	5.16	0.43	1.875-16 UN	1.79	0.78	0.75	1.63	.500-13 UNC	-	-	0.31	0.67	0.47	3.9
<b>▼ Double acting</b>																
CDT-18131	3.19	2.68	2.42	0.63	1.875-16 UN	1.73	0.63	0.59	1.61	.313-24 UNF	0.53	0.39	0.26	0.50	0.47	2.4
CDT-18251	4.21	3.23	2.97	0.63	1.875-16 UN	1.73	0.63	0.59	1.61	.313-24 UNF	0.53	0.39	0.26	0.50	0.47	2.9
CDT-18381	5.18	3.68	3.43	0.63	1.875-16 UN	1.73	0.63	0.59	1.61	.313-24 UNF	0.53	0.39	0.26	0.50	0.47	3.4
CDT-18501	6.12	4.15	3.90	0.63	1.875-16 UN	1.73	0.63	0.59	1.61	.313-24 UNF	0.53	0.39	0.26	0.50	0.47	3.9
CDT-27151	3.37	2.80	2.54	0.67	2.125-16 UN	2.02	0.71	0.67	1.87	.375-16 UNC	0.65	0.39	0.26	0.62	0.47	2.6
CDT-27251	4.20	3.23	2.97	0.67	2.125-16 UN	2.02	0.71	0.67	1.87	.375-16 UNC	0.65	0.39	0.26	0.62	0.47	3.1
CDT-27501	6.17	4.21	3.96	0.67	2.125-16 UN	2.02	0.71	0.67	1.87	.375-16 UNC	0.65	0.39	0.26	0.62	0.47	4.1
CDT-40131	3.60	3.09	2.78	0.70	2.500-16 UN	2.38	0.86	0.83	2.25	.500-13 UNC	0.80	0.39	0.31	0.67	0.59	4.0
CDT-40251	4.55	3.56	3.25	0.70	2.500-16 UN	2.38	0.86	0.83	2.25	.500-13 UNC	0.80	0.39	0.31	0.67	0.59	4.6
CDT-40381	5.57	4.07	3.76	0.70	2.500-16 UN	2.38	0.86	0.83	2.25	.500-13 UNC	0.80	0.39	0.31	0.67	0.59	5.6
CDT-40501	6.89	4.92	4.61	0.70	2.500-16 UN	2.38	0.86	0.83	2.25	.500-13 UNC	0.80	0.39	0.31	0.67	0.59	6.6

Shown: WRT-22, CYDA-15, WMT-39



▶ **Threaded cylinders for workpiece positioning, holding and ejecting applications where space is at a premium. The advance and retract mode of double-acting models allow installation of clamping accessories to the plunger for pull and push action. Cylinders can be mounted with horizontal bracket to position the workpiece against the stops. Ideal for supporting or positioning a part.**

## Fine positioning and convenient installation

...can be fixtured into manual strap or bridge clamp assemblies

- Maximum clamping force in a compact design
- Threaded body allows exact positioning and easy installation
- Center-tapped plungers allow a variety of attachments
- Single-acting spring return models simplify hydraulic tubing requirements
- Double-acting models are ideal for applications requiring powered pulling or fast automated control
- Removable base allows CYDA-15 to be threaded into a custom manifold

## **i** Single or Double acting

### Single acting

- The obvious choice when there are few system restrictions, and there are not many units retracting simultaneously
- Fewer valving requirements which results in a less complex circuit

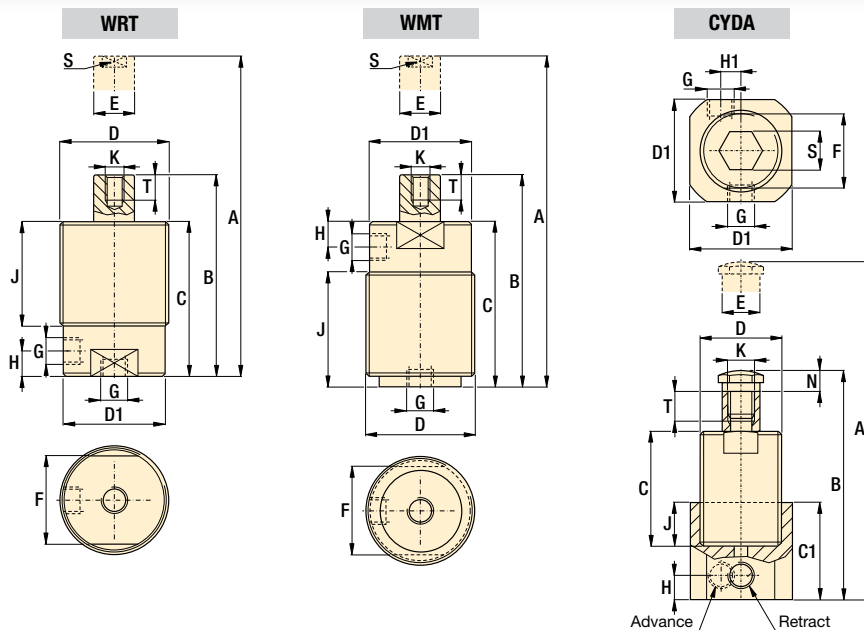
### Double acting

- Used when greater control is required during the unclamp cycle
- When timing sequences are critical
- Less sensitive to system back pressures, resulting from long tube lengths or numerous components being retracted at the same time

## **globe** Product selection

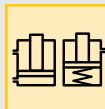
Cylinder capacity at maximum pressure	Stroke		Model number	Effective area		Oil capacity		Operating pressure
	lbs	in		in <sup>2</sup>	in <sup>3</sup>			
	push	pull		push	pull	push	pull	
<b>▼ Single acting</b>								
3900	–	.50	<b>WRT-21</b>	.79	–	.39	–	150-5000
3900	–	1.00	<b>WRT-22</b>	.79	–	.79	–	150-5000
<b>▼ Double acting</b>								
1200	600	1.56	<b>CYDA-15</b>	.41	.20	.62	.31	150-3000
3900	2700	.47	<b>WMT-39</b>	.79	.54	.39	.27	150-5000
3900	2700	.98	<b>WMT-40</b>	.79	.54	.79	.54	150-5000

**Note:** - Seal material CYDA-15: Buna-N, Polyurethane  
 - Seal material WMT and WRT series: Buna-N, Polyurethane, Teflon.

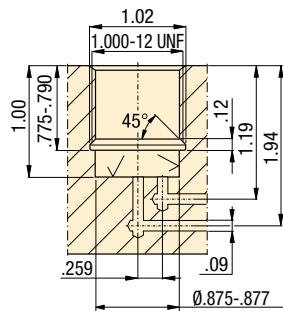


**Force: 1200-3900 lbs**  
**Stroke: .47-1.56 inch**  
**Pressure: 150-5000 psi**

- E** Cilindros roscados
- F** Vérins corps filetés
- D** Einschraubzylinder



Manifold dimensions using CYDA-15 without base (Cylinder Capacity 1200 lbs)



✓ Surface roughness must be 63 micro-inches

### Accessory chart

Body Thread	Mounting Flange	Flange Nut	Plunger Thread	Contact Bolt
D	Sold separately [87 ▶]	Sold separately [86 ▶]	K	Sold separately [86 ▶]
1.000-12 UN	MF-251	FN-251	0.250-28 UN	BS-61
1.375-18 UN	MF-351	FN-351	0.313-24 UN	BS-81

### Product dimensions in inches [ ]

Model number	A	B	C	C1	D	D1	E	F	G	H	H1	J	K	N	S	T	lbs
					UN	ø	ø						UNF				
<b>▼ Single acting</b>																	
<b>WRT-21</b>	3.75	3.25	2.95	-	1.375-18 UNEF	1.23	.75	1.06	SAE #2	.62	-	2.0	.250-28	-	.50	.32	1.2
<b>WRT-22</b>	4.75	3.75	3.45	-	1.375-18 UNEF	1.23	.75	1.06	SAE #2	.62	-	2.5	.250-28	-	.50	.32	1.4
<b>▼ Double acting</b>																	
<b>CYDA-15</b>	5.98	4.42	3.15	1.75	1.000-12 UNF	1.25	.50	.87	.125-27 NPT	.38	.20	1.00	.313-24	.31	.50	.41	1.2
<b>WMT-39</b>	3.74	3.27	2.99	-	1.375-18 UNEF	1.30	.56	1.06	.125-27 NPT	.73	-	2.05	.250-28	-	.47	.39	1.0
<b>WMT-40</b>	4.76	3.78	3.50	-	1.375-18 UNEF	1.30	.56	1.06	.125-27 NPT	.73	-	2.56	.250-28	-	.47	.39	1.2

### Options

Cylinder accessories

[86 ▶]



### Important

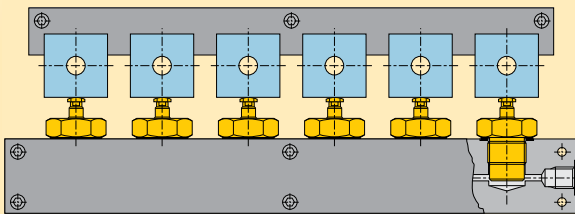
Apply Loctite 222 or equivalent to threads and torque CYDA-15 in cavity to 72-96 in-lbs. Cavity must be designed to withstand hydraulic forces.

# Manifold cylinders *Application & selection*

Shown: CSM-10131, CSM-571, CSM-18251



▶ These compact, fixture-integrated cylinders are designed for workpiece positioning, holding and ejecting applications where space is at a premium. No exposed tubing.



Six CSM series manifold cylinders are used to clamp piston blocks for machining. The hydraulic flow to the cylinders is side-ported in order to minimize the required manifold thickness.

■ Threaded cylinders are used here to position engine manifolds for drilling, tapping and mill finish.

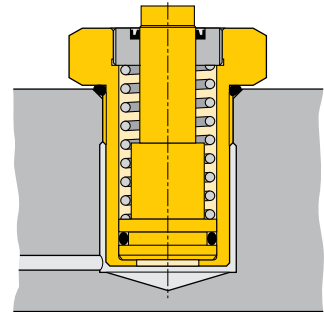


## Compact, fixture-integrated positioning and holding

- Design eliminates the need for fittings and tubing, minimizing space requirements and facilitating easy removal of chips and dirt
- Minimal cylinder height enables extremely compact fixture designs
- High-strength bodies and internal plunger wipers allow maintenance-free, high cycle performance
- Center-tapped plungers will hold workpiece contact buttons
- Standard SAE bodies make manifold cavity preparation easy

## i Manifold mount

Manifold cylinders are designed to be screwed directly into a manifold or fixture. Enerpac's manifold cylinders feature SAE dimensions, enabling the use of standard SAE porting tools for easy cavity preparation. An SAE O-ring, included with each cylinder, provides an effective seal between the cylinder and manifold.



## Product selection

Cylinder capacity at 5000 psi	Stroke	Model number	Effective area	Oil capacity
			in <sup>2</sup>	in <sup>3</sup>
380 lbs	0.28 in	<b>CSM-271</b>	0.08	0.02
380	0.51	<b>CSM-2131</b>	0.08	0.04
1190	0.28	<b>CSM-571</b>	0.24	0.07
1190	0.51	<b>CSM-5131</b>	0.24	0.12
2590	0.28	<b>CSM-1071</b>	0.50	0.14
2590	0.51	<b>CSM-10131</b>	0.50	0.26
2590	0.75	<b>CSM-10191</b>	0.50	0.38
3900	0.51	<b>CSM-18131</b>	0.79	0.40
3900	0.98	<b>CSM-18251</b>	0.79	0.77
6110	0.59	<b>CSM-27151</b>	1.22	0.72
6110	0.98	<b>CSM-27251</b>	1.22	1.20

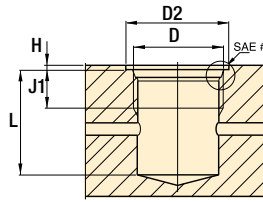
Note: - Seal material: Buna-N, Polyurethane.

Collet-Lok® product line  
Swing clamps  
Work supports  
Linear clamps

**Installation dimensions** in inches [ ]

Model number	D Thread SAE	D2 min. $\phi$	H max.	J1 min.	L min.
<b>CSM-271</b>	SAE#6 (9/16"-18 UN)	0.97	0.064	0.50	.96
<b>CSM-2131</b>	SAE#6 (9/16"-18 UN)	0.97	0.064	0.50	1.45
<b>CSM-571</b>	SAE#10 (7/8"-14 UN)	1.34	0.094	0.66	1.20
<b>CSM-5131</b>	SAE#10 (7/8"-14 UN)	1.34	0.094	0.66	1.53
<b>CSM-1071</b>	SAE#12 (1-1/16"-12 UN)	1.63	0.094	0.75	1.20
<b>CSM-10131</b>	SAE#12 (1-1/16"-12 UN)	1.63	0.094	0.75	1.44
<b>CSM-10191</b>	SAE#12 (1-1/16"-12 UN)	1.63	0.094	0.75	2.05
<b>CSM-18131</b>	SAE#16 (1-5/16"-12 UN)	1.91	0.125	0.75	1.57
<b>CSM-18251</b>	SAE#16 (1-5/16"-12 UN)	1.91	0.125	0.75	2.34
<b>CSM-27151</b>	SAE#20 (1-5/8"-12 UN)	2.27	0.125	0.80	1.66
<b>CSM-27251</b>	SAE#20 (1-5/8"-12 UN)	2.27	0.125	0.80	2.38

**Installation dimensions**



- Force: 380-6110 lbs**
- Stroke: .28-.98 inch**
- Pressure: 580-5000 psi**

- E Cilindros para colector**
- F Vérins pour bloc foré**
- D Einbauszylinder**

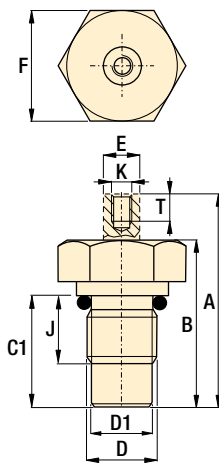


**Note:** - O-rings included. For additional cavity machining information, refer to SAE standards for straight internal thread, O-ring boss, or call Enerpac's Technical Service Department.

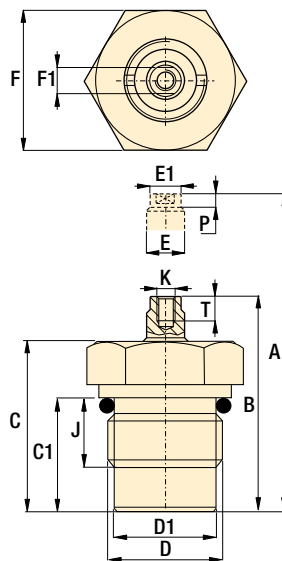
**Accessory chart**

Plunger Thread K	Contact Bolt $\square$ 86 ▶
#6-32 UN	BS-21
#8-32 UN	BS-41
0.313-24 UN	BS-81
0.375-16 UN	BS-91

**CSM-271, -2131**



**other models**



**Product dimensions** in inches [ ]

Model number	A Ext. height	B Retr. height	C	C1	D thread	D1 $\phi$	E $\phi$	E1 $\phi$	F	F1	J	K thread	P	T	lbs
<b>CSM-271</b>	1.61	1.33	-	0.91	.563-18 UN	0.47	0.19	-	0.75	-	0.48	#6-32 UN	-	0.19	0.2
<b>CSM-2131</b>	2.22	1.71	-	1.40	.563-18 UN	0.47	0.19	-	0.75	-	0.47	#6-32 UN	-	0.19	0.3
<b>CSM-571</b>	2.02	1.74	1.57	1.14	.875-14 UN	0.69	0.31	0.27	1.06	0.25	0.55	#8-32 UN	0.16	0.28	0.4
<b>CSM-5131</b>	2.58	2.07	1.91	1.48	.875-14 UN	0.69	0.31	0.27	1.06	0.25	0.55	#8-32 UN	0.16	0.28	0.6
<b>CSM-1071</b>	2.15	1.87	1.65	1.14	1.062-12 UN	0.94	0.47	0.43	1.25	0.35	0.59	.312-24 UN	0.22	0.32	1.1
<b>CSM-10131</b>	2.65	2.14	1.89	1.38	1.062-12 UN	0.94	0.47	0.43	1.25	0.35	0.59	.312-24 UN	0.22	0.31	1.3
<b>CSM-10191</b>	3.50	2.75	2.50	1.99	1.062-12 UN	0.94	0.47	0.43	1.25	0.35	0.63	.312-24 UN	0.22	0.31	1.4
<b>CSM-18131</b>	2.87	2.36	2.11	1.52	1.312-12 UN	1.17	0.63	0.59	1.61	0.50	0.79	.312-24 UN	0.26	0.47	1.1
<b>CSM-18251</b>	4.11	3.13	2.87	2.28	1.312-12 UN	1.18	0.63	0.59	1.61	0.50	0.79	.312-24 UN	0.26	0.47	1.3
<b>CSM-27151</b>	3.13	2.54	2.31	1.60	1.625-12 UN	1.52	0.71	0.67	2.17	0.57	0.79	.375-16 UN	0.26	0.47	1.50
<b>CSM-27251</b>	4.25	3.27	3.04	2.33	1.625-12 UN	1.52	0.71	0.67	2.17	0.57	0.79	.375-16 UN	0.26	0.47	2.00

**Options**

**Accessories**  
Contact bolts  $\square$  86 ▶

**Important**

**Tighten manifold cylinders according to specifications in the instruction sheet.**

**Return springs in single-acting cylinders should not be used to pull back heavy attachments.**

# Block cylinders *Application & selection*

Shown: CDB-10162, CDB-70502, CSB-18252



▶ Block cylinders are used for punching, pressing, riveting and bending applications. In general, these cylinders are used for moving, positioning, lifting, opening and closing.

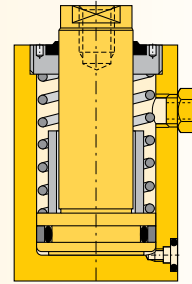
## Versatile, all purpose cylinder

- Six clamping capacities enable you to choose the right size for your application
- Variety of strokes, to meet design needs
- Double acting and Single acting (spring return), allows selection of cylinder that best conforms to your hydraulic system
- Oil connection alternatives: cylinders incorporate both manifold mount and plumbed options to meet your fixturing needs
- Compact cylinder design does not require large amounts of space on your fixture
- Integral wiper ring, keeps contaminants out of cylinder to extend life

## **i** Select your block cylinder type:

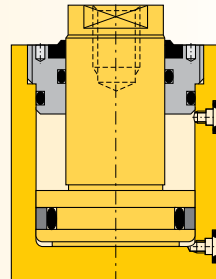
### **CSB series, Single acting**

- Internal threaded plunger
- Manifold O-ring ports
- Black oxide base
- Hard chrome-plated plunger
- BSPP oil port
- Strong return spring
- Filtered vent plug



### **CDB series, Double acting**

- Internal threaded plunger
- Manifold O-ring ports
- Black oxide base
- Hard chrome-plated plunger
- BSPP oil port



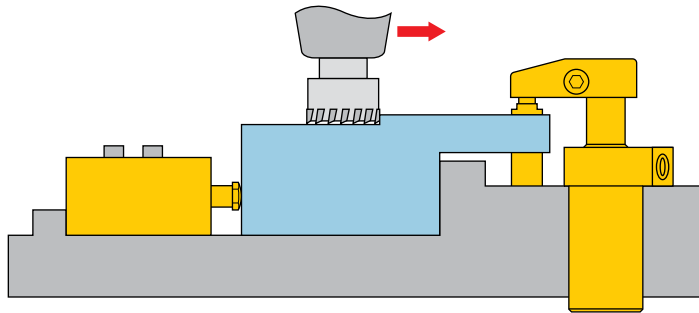
■ The versatile Enerpac block cylinders, fixture mounted for clamping applications.





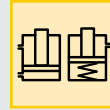
**i Application example**

Block cylinder positions workpiece against fixed point with further clamping coming from an Enerpac swing cylinder.



<b>Force:</b> 2400-60,850 lbs
<b>Stroke:</b> .59-2.20 inch
<b>Pressure:</b> 580-5000 psi

- E** Cilindros tipo bloque
- F** Vérins cube
- D** Blockzylinder



**Accessory chart**

Plunger Thread K	Contact Bolt □86 ▶
M6 X 1,0	BS-62
M8 X 1,25	BS-82
M16 X 2,0	BS-16
M20 X 2,5	BS-20
M30 X 3,5	BS-30
M36 X 4,0	BS-36

**Product selection**

Piston Ø	Rod Ø	Clamping force at 5000 psi		Stroke	Model number	Cylinder effective area		Cylinder oil capacity		Minimum spring return force	
		push	pull			push	pull	push	pull	lbs	lbs
in	in	lbs		in		in <sup>2</sup>		in <sup>3</sup>		lbs	
						push	pull	push	pull	lbs	lbs
<b>▼ Single acting</b>											
.78	.47	2400	–	.71	<b>CSB-10182</b>	.48	–	.35	–	24	2.6
.98	.63	3800	–	.98	<b>CSB-18252</b>	.76	–	.75	–	35	4.0
1.57	.98	9750	–	.98	<b>CSB-40252</b>	1.95	–	1.92	–	85	5.9
1.97	1.26	15,200	–	.98	<b>CSB-70252</b>	3.04	–	3.00	–	96	9.7
<b>▼ Double acting</b>											
.78	.47	2400	1550	.59	<b>CDB-10162</b>	.48	.31	.31	.20	–	2.0
.78	.47	2400	1550	1.38	<b>CDB-10362</b>	.48	.31	.69	.44	–	2.6
.98	.63	3800	2250	.79	<b>CDB-18202</b>	.76	.45	.60	.35	–	2.9
.98	.63	3800	2250	1.97	<b>CDB-18502</b>	.76	.45	1.50	.90	–	4.0
1.57	.97	9750	4900	.98	<b>CDB-40252</b>	1.95	.98	1.92	.96	–	4.2
1.57	.97	9750	4900	1.97	<b>CDB-40502</b>	1.95	.98	3.83	1.93	–	5.7
1.97	1.26	15,200	9000	.98	<b>CDB-70252</b>	3.04	1.80	3.00	1.77	–	7.1
1.97	1.26	15,200	9000	1.97	<b>CDB-70502</b>	3.04	1.80	5.99	3.54	–	9.5
3.15	1.97	38,900	23,700	.98	<b>CDB-180252</b>	7.80	4.74	7.66	4.67	–	20.5
3.15	1.97	38,900	23,700	1.97	<b>CDB-180502*</b>	7.80	4.74	15.33	9.34	–	25.4
3.93	2.48	60,850	36,650	2.20	<b>CDB-280562*</b>	12.17	7.33	26.83	16.18	–	40.1

\* This product is made to order. Please contact Enerpac for delivery information before specifying in your design.

# Block cylinders *Application & selection*

Shown: CDB-10162, -70502, CSB-18252



## CDB, CSB series

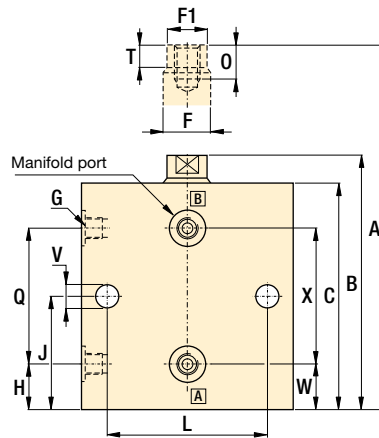
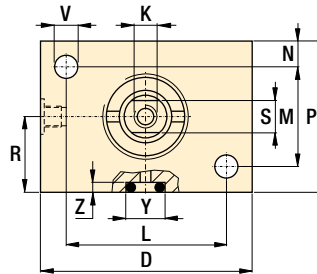
These compact block cylinders are easily mounted in horizontal or vertical position for a range of special tooling applications.

They can be used for positioning, clamping, pushing, pressing or punching operations. The plunger has an internal thread to accommodate accessories such as contact bolts.

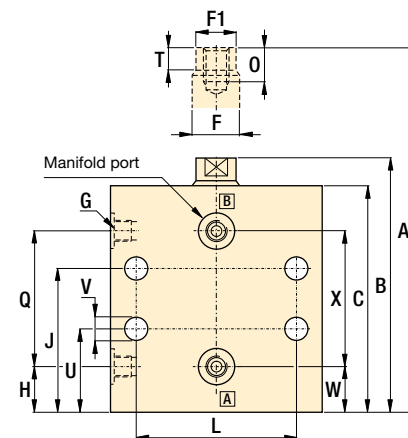
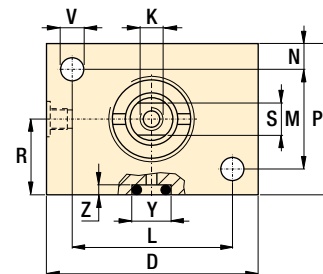
Block cylinder used for punching applications.



CDB-10162, -18202, -40252, -70252, -180252



All other models



## Dimensions in inches [ $\frac{1}{16}$ ]

Model number	A	B	C	D	F	F1	G	H	J	K	L	M
					ø	ø				ø		
▼ Single acting												
CSB-10182	3.94	3.23	2.91	2.36	.47	.43	G1/8"	.47	1.75	M6 x 1,0	1.77	.98
CSB-18252	4.92	3.94	3.62	2.56	.63	.59	G1/8"	.47	2.24	M8 x 1,25	1.97	1.18
CSB-40252	5.13	4.15	3.66	3.15	.98	.94	G1/8"	.39	2.26	M16 x 2,0	2.36	1.38
CSB-70252	5.63	4.65	4.09	3.94	1.26	1.22	G1/4"	.54	2.52	M20 x 2,5	3.15	1.77
▼ Double acting												
CDB-10162	3.03	2.44	2.15	2.36	.47	.43	G1/8"	.47	.96	M6 x 1,0	1.77	.98
CDB-10362	4.61	3.23	2.93	2.36	.47	.43	G1/8"	.47	1.75	M6 x 1,0	1.77	.98
CDB-18202	3.54	2.76	2.44	2.56	.63	.59	G1/8"	.47	1.06	M8 x 1,25	1.97	1.18
CDB-18502	5.91	3.94	3.62	2.56	.63	.59	G1/8"	.47	2.24	M8 x 1,25	1.97	1.18
CDB-40252	4.13	3.15	2.68	3.15	.97	.94	G1/8"	.37	1.26	M16 x 2,0	2.36	1.38
CDB-40502	6.11	4.15	3.67	3.15	.97	.94	G1/8"	.39	2.26	M16 x 2,0	2.36	1.38
CDB-70252	4.53	3.54	2.99	3.94	1.26	1.22	G1/4"	.53	1.42	M20 x 2,5	3.15	1.77
CDB-70502	6.61	4.65	4.09	3.94	1.26	1.22	G1/4"	.54	2.52	M20 x 2,5	3.15	1.77
CDB-180252	5.16	4.17	3.50	5.51	1.97	1.93	G1/4"	.59	1.63	M30 x 3,5	4.33	3.15
CDB-180502*	7.28	5.31	4.65	5.51	1.97	1.93	G1/4"	.47	2.78	M30 x 3,5	4.33	3.15
CDB-280562*	8.19	5.98	5.22	6.69	2.48	2.44	G1/4"	.70	3.05	M36 x 4,0	5.31	3.54

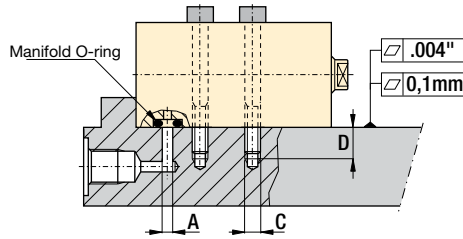
\* This product is made to order. Please contact Enerpac for delivery information before specifying in your design.

**i** Installation instructions

When operating above 2000 psi in applications as shown in the figure below, provide cylinder back-up using a support to eliminate shear loads on the mounting bolts.

**Manifold mounting**

When hydraulic connections are made through the standard integrated O-ring ports as shown in figure, the sealing surface must have a roughness of 63 micro-inches.



**Single-acting cylinders**

If the risk of machining coolants or debris being entering via the breather vent (port B) exists, it is recommended that this port be connected to a clean, remote termination point.

**A** Installation dimensions in inches [ ]

Clamping capacity	Oil channel diameter	Mounting thread	Min. thread length	Torque (bolt type 12.9 DIN 912)	Manifold O-ring <sup>1)</sup>	
					Inside Ø x thickness	ARP No.
lbs	A	mm C	D	Ft.lbs		
2400	.20	M6	.43	13	.31 x .06	568-011
3800	.20	M8	.51	30	.31 x .06	568-011
9750	.20	M10	.63	63	.31 x .06	568-011
15,200	.20	M12	.75	107	.31 x .06	568-011
38,900	.31	M16	.94	260	.38 x .09	568-110
60,850	.31	M20	1.10	498	.38 x .09	568-110

<sup>1)</sup> Manifold O-rings included

N	O	P	Q	R	S	T	U	V	W	X	Y	Z	Model number
min.													
													<b>Single acting ▼</b>
.30	.39	1.57	1.77	.79	.35	.22	.96	.27	.47	1.77	.44	.05	<b>CSB-10182</b>
.30	.49	1.77	2.36	.89	.51	.24	1.06	.35	.47	2.36	.44	.05	<b>CSB-18252</b>
.39	.98	2.17	2.46	1.08	.87	.37	1.07	.42	.39	2.46	.44	.05	<b>CSB-40252</b>
.41	1.18	2.60	2.63	1.30	1.06	.43	1.15	.49	.60	2.57	.44	.05	<b>CSB-70252</b>
													<b>Double acting ▼</b>
.30	.39	1.57	.98	.79	.35	.22	-	.27	.47	.98	.44	.05	<b>CDB-10162</b>
.30	.39	1.57	1.77	.79	.35	.22	.96	.27	.47	1.77	.44	.05	<b>CDB-10362</b>
.30	.49	1.77	1.18	.89	.51	.24	-	.35	.47	1.18	.44	.05	<b>CDB-18202</b>
.30	.49	1.77	2.36	.89	.51	.24	1.06	.35	.47	2.36	.44	.05	<b>CDB-18502</b>
.39	.98	2.17	1.48	1.08	.87	.37	-	.42	.37	1.48	.44	.05	<b>CDB-40252</b>
.39	.98	2.17	2.46	1.08	.87	.37	1.07	.42	.39	2.46	.44	.05	<b>CDB-40502</b>
.41	1.18	2.60	1.54	1.30	1.06	.43	-	.49	.49	1.57	.44	.05	<b>CDB-70252</b>
.41	1.18	2.60	2.63	1.30	1.06	.43	1.15	.49	.60	2.57	.44	.05	<b>CDB-70502</b>
.59	1.77	4.33	1.79	2.17	1.61	.57	-	.67	.61	1.77	.56	.07	<b>CDB-180252</b>
.59	1.77	4.33	3.05	2.17	1.61	.57	1.20	.67	.77	2.76	.56	.07	<b>CDB-180502*</b>
.69	1.97	4.92	3.16	2.46	1.97	.67	1.48	.83	.71	3.15	.56	.07	<b>CDB-280562*</b>

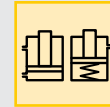
\* This product is made to order. Please contact Enerpac for delivery information before specifying in your design.

**Force: 2400-60,850 lbs**

**Stroke: .59-2.20 inch**

**Pressure: 580-5000 psi**

- E** Cilindros tipo bloque
- F** Vérins cube
- D** Blockzylinder



**! Important**

**Linear cylinder support is required at operating pressures above 2000 psi. Follow the instructions on this page.**

**💡 Options**

**Contact bolts** [86 ▶](#)

**Fittings** [194 ▶](#)

**Pressure gauges** [190 ▶](#)

**High pressure filters** [193 ▶](#)

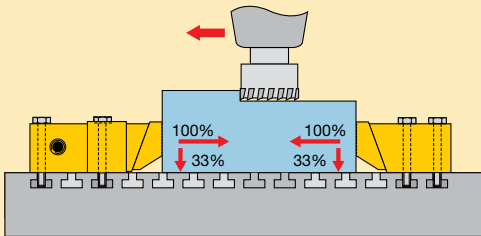
Linear cylinders Power sources Valves Pallet components System components Yellow pages

# Pull down clamps *Application & selection*

Shown: ECM-20, ECH-202, ECM-5, ECH-52



**Enerpac pull down clamps are designed to allow unobstructed top face machining. Independent horizontal and vertical movement achieves high lateral and pull down forces to hold the workpiece firmly down against the machine table or fixture. The pull down forces are approximately 33% of the clamping force.**



The pull down clamps can be permanently mounted using the supplied mounting bolts. Optional T-nuts can be used for adapting to varying workpiece sizes.

■ Enerpac hydraulic pull down clamps and their mechanical counter parts used to manufacture tie-rod cylinder end caps.

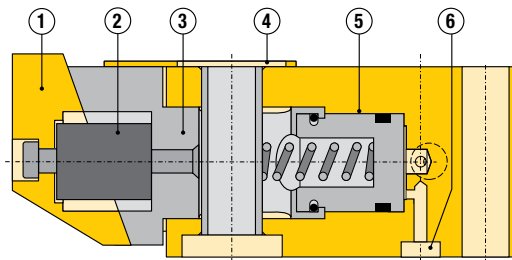


## Low profile clamp

.....for unobstructed top face machining

- Independent horizontal and vertical movement for a true pull down effect
- Compact size and low height allows more flexible and economic mounting than comparable dedicated vise
- Manifold and BSPP porting
- Investment high-alloy cast, heat-treated clamping jaw and plunger
- Contamination resistant design for low maintenance, removable guard for chip removal
- Oil ports on both sides for mounting flexibility
- Optional mechanical counter hold provides pull down on end stop for large parts
- Mounting bolts included for ease of installation

## **i** Pull down clamp operation



The moveable jaw ① and the flexible connection design ② allows lateral movement and eliminate any bending moment. Roller finished cylinder bore ③ improves seal life. The removable guard ④ prevents the entry of chips and allows easy cleaning. Heat treated, centerless ground plunger ⑤ for extremely close tolerances and long life. The clamps feature both manifold mount ⑥ and plumbed oil connection.

## **globe** Product selection

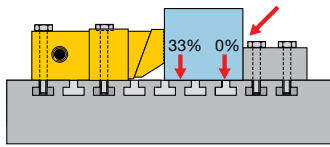
Lateral clamping force at 5000 psi	Pull down force at 5000 psi	Stroke	Model number	Effective area	Oil capacity	Mounting bolts <sup>1)</sup> (included)
lbs	lbs	in		in <sup>2</sup>	in <sup>3</sup>	mm
<b>▼ Hydraulic pull down clamps</b>						
870	290	.20	<b>ECH-52</b>	.18	.03	M8 x 45
3900	1300	.31	<b>ECH-202</b>	.78	.24	M12 x 80

Holding force	For pull down clamp model number	Model number	Mounting bolts included <sup>1)</sup> number	Replaceable ribbed jaws model
lbs			mm	
<b>▼ Mechanical counter holds</b>				
870	ECH-52	<b>ECM-5</b>	M8 x 35	ECJR-5
3900	ECH-202	<b>ECM-20</b>	M12 x 65	ECJR-20

<sup>1)</sup> Torque M8 with 18 Ft.lbs, M12 with 63 Ft.lbs. The use of T-nuts requires longer bolts.

Collet-Lok® product line  
Swing clamps  
Work supports  
Linear clamps

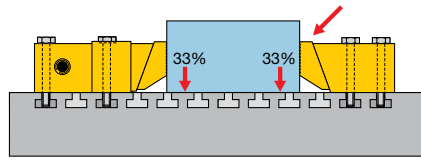
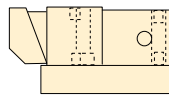
**i Pull down force**



**Fixed stop set-up**

A very workable set-up for workpieces that are not larger or wider than twice the width of the edge clamp. The pull down force of the hydraulic actuated edge clamp is sufficient to pull down and hold the product during actual machining.

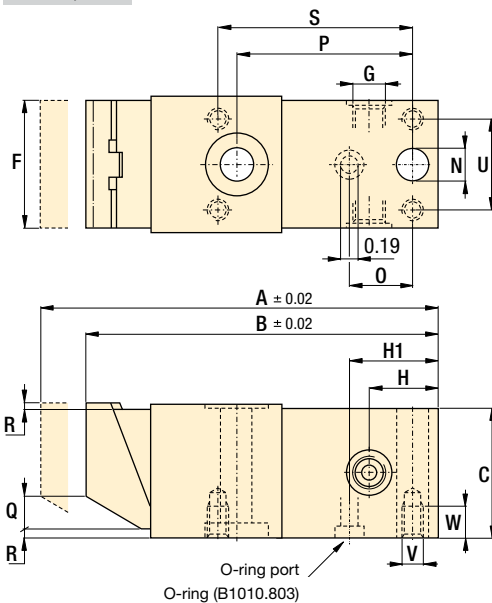
The mounting surface must extend out under the jaw.



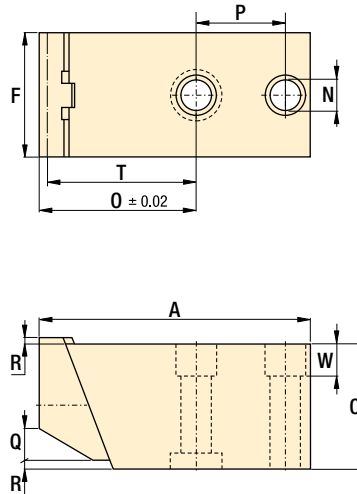
**Counter hold set-up**

For workpieces larger than twice the width of the edge clamp used, it is recommended to install a mechanical counter hold. The counter hold also produces a pull down force equal to 1/3 of the lateral force of the hydraulic edge clamp applied. In this way the grip on the workpiece is very tight. Another advantage of this set-up is the repeated accuracy of machining results.

ECH-52, -202



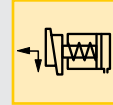
ECM-5, -20



**A Product dimensions in inches [  $\varnothing$  ]**

Model number	A	B	C	F	G	H	H1	N	O	P	Q	R	S	T	U	V	W	lbs
	mm																	
<b>▼ Hydraulic pull down clamps</b>																		
ECH-52	4.14	3.94	1.18	1.18	G1/8"	.75	.74	.33	.46	2.09	.12	.08	2.32	-	.87	M5 x 0,8	.24	1.5
ECH-202	5.62	5.31	1.97	1.97	G1/4"	.98	.93	.49	.54	2.64	.55	.12	2.91	-	1.42	M8 x 1,25	.47	5.5
<b>▼ Mechanical counter holds</b>																		
ECM-5	3.11	-	1.18	1.18	-	-	-	.33	1.65	1.02	.12	.08	-	1.61	-	-	.31	1.3
ECM-20	4.02	-	1.97	1.97	-	-	-	.49	2.36	1.18	.55	.12	-	2.32	-	-	.51	4.1

- Force: 870-3900 lbs
- Stroke: .20-.31 inch
- Pressure: 225-5000 psi
- E** Garras de empuje oblicuo
- F** Crampons plaqueurs
- D** Niederzugspanner



**i Options**

- Fittings** 194 ▶
- Threaded cylinders** 66 ▶
- Positive clamping cylinders** 80 ▶

**! Important**

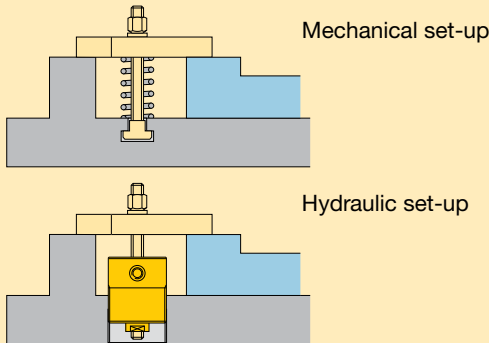
Do not allow the clamping jaw to extend below the lower surface of the clamp body.

# Hollow plunger cylinders *Application & selection*

Shown: HCS-20, RWH-121, RWH-202

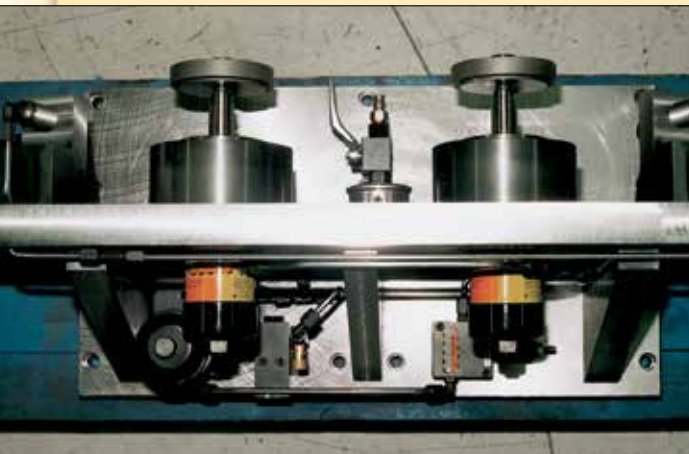


▶ These cylinders are regularly used for upgrading mechanical clamping to faster and easier hydraulic clamping. Other typical applications include production pressing, punching and crimping operations.



Traditional mechanical elements in a clamping fixture are replaced by a hollow plunger hydraulic cylinder.

■ Two Enerpac RWH-121 hollow cylinders mounted at the back side of a fixture.



## For high force push and pull applications on and around the fixture

- Load can be attached to either end of the cylinder, providing a choice of push or pull actions - both realizing full cylinder capacity
- Very high cylinder capacities contained within small dimensions allow compact fixture designs
- Spring return operation allows for easy unloading of the workpiece
- Threaded collars and base mounting holes allow mounting flexibility, including table-top surfaces and T-slots
- Nickel-plated plungers, plunger wipers and internal venting prevent corrosion and support longer operation life on all HCS models
- The CY series hollow plunger cylinders can be manifold mounted (except for CY-1254-25)

## Product selection

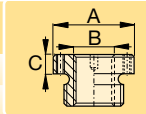
Cylinder capacity <sup>1)</sup>	Stroke	Center hole diameter	Model number	Effective area	Oil capacity	Operating pressure
				in <sup>2</sup>	in <sup>3</sup>	psi
2610	0.25	0.39	<b>CY1254-25</b>	0.87	0.22	3000
4000	0.33	0.53	<b>MRH-20</b>	1.33	0.41	3000
4000	0.33	0.53	<b>RWH-20</b>	1.33	0.41	3000
4000	0.33	0.53	<b>RWH-20T</b>	1.33	0.41	3000
4830	0.40	0.42	<b>HCS-20*</b>	0.96	0.38	5000
7410	0.31	0.77	<b>CY2129-25<sup>1)</sup></b>	2.47	0.77	3000
7410	0.63	0.77	<b>CY2129-5<sup>1)</sup></b>	2.47	1.56	3000
12,660	0.48	0.51	<b>HCS-50*</b>	2.52	1.19	5000
13,320	0.63	0.89	<b>CY2754-5</b>	4.44	2.80	3000
13,800	0.32	0.77	<b>MRH-120</b>	2.76	0.86	5000
13,800	0.32	0.77	<b>QDH-120</b>	2.76	0.86	5000
13,800	0.32	0.77	<b>RWH-120</b>	2.76	0.86	5000
13,800	1.02	0.77	<b>RWH-121</b>	2.76	2.76	5000
18,180	0.56	0.67	<b>HCS-80*</b>	3.63	1.99	5000
23,500	0.52	1.06	<b>RWH-200</b>	4.74	2.37	5000
23,500	2.02	1.06	<b>RWH-202</b>	4.74	9.48	5000
25,490	0.63	0.83	<b>HCS-110*</b>	5.06	3.19	5000
36,000	0.50	1.31	<b>RWH-300</b>	7.22	3.60	5000
36,000	1.00	1.31	<b>RWH-301</b>	7.22	7.22	5000
36,000	2.49	1.31	<b>RWH-302</b>	7.22	18.00	5000

<sup>1)</sup> At maximum operating pressure. **Note:** Seal material Buna-N, Polyurethane, Teflon.  
\* This product is made to order. Please contact Enerpac for delivery information before specifying in your design.

Collet-Lok® product line  
Swing clamps  
Work supports  
Linear clamps

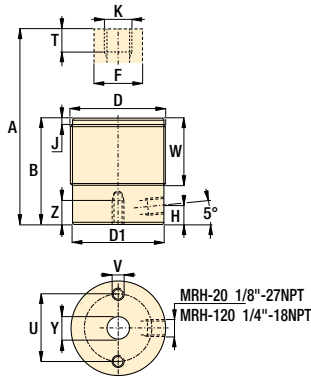
**i** Optional Heat Treated Hollow Saddles

Saddle type	Cylinder model number	Saddle model No.	Saddle Dimensions (in)		
			A	B	C
Threaded hollow	RWH-200, 202	HP-2015	2.11	1 - 8	.38
	RWH-300, 301, 302	HP-3015	2.49	1¼ - 7	.38

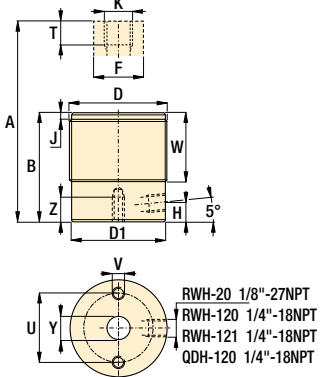


Smooth hollow saddles are standard on all RWH 20 and 30 ton models (12 ton models are not equipped with saddles).

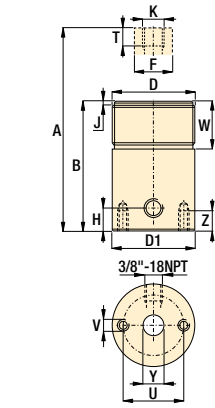
**MRH-20, 120**



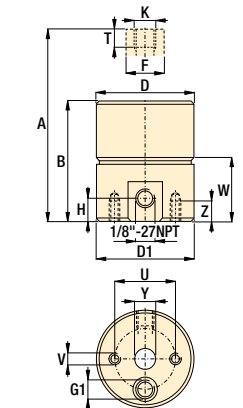
**RWH-20, 120, 121, QDH-20**



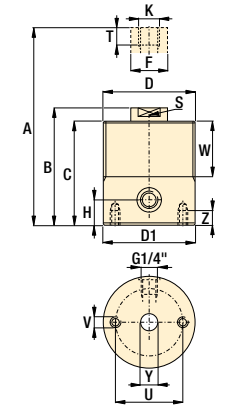
**other RWH model**



**CY models**

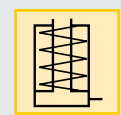


**HCS models**



- Force:** 2610-36,000 lbs
- Stroke:** .25-2.49 inch
- Pressure:** 800-5000 psi

- E** Cilindros de émbolo hueco
- F** Vérins a piston creux
- D** Hohlkolbenzylinder



**i** Options

**Flange nuts**

86 ▶

**! Important**

**Use Grade 8 (DIN12.9) bolt quality or better for pulling. Use Grade B7 (DIN10.9) threaded rod quality or better for pulling applications.**

**RWH cylinders can be used up to 10,000 psi maximum working pressure (except RWH-20 and RWH120).**

**A** Product dimensions in inches [ ]

Model number	A	B	C	D	D1	F	H	J	K	S	T	U	V	W	Y	Z	lbs
<b>CY1254-25</b>	2.25	2.00	-	Ø 1.75	1.75	0.56	0.29	-	.375-16 UNC	-	0.62	1.25	.250-20 UNC	0.97	Ø 0.39	0.38	1.0
<b>MRH-20</b>	2.39	2.06	-	M48 X 1.5	1.77	1.00	0.28	0.12	Ø .53	-	0.88	1.38	M6 X 1.0	1.50	Ø 0.50	0.25	1.3
<b>RWH-20</b>	2.39	2.06	-	1.875-16 UN	1.79	1.00	0.28	0.12	Ø .53	-	0.87	1.38	.250-20 UNC	1.50	.500-20 UNF	0.25	1.4
<b>RWH-20T</b>	2.39	2.06	-	1.875-16 UN	1.79	1.00	0.28	0.12	.500-20 UNF	-	0.49	1.38	.250-20 UNC	1.50	Ø 0.53	0.25	1.4
<b>HCS-20</b>	3.43	2.93	2.60	M58 X 1.5	2.28	0.71	0.43	-	M10 X 1.5	0.55	1.01	1.57	M6 X 1.0	1.57	Ø 0.42	0.39	2.4
<b>CY2129-25<sup>1)</sup></b>	2.31	2.00	-	Ø 2.63	2.50	1.13	0.31	-	.750-10 UNC	-	1.13	1.75	.375-16 UNC	0.80	Ø 0.77	0.34	2.5
<b>CY2129-5<sup>1)</sup></b>	3.36	2.73	-	Ø 2.63	2.50	1.13	0.31	-	.750-10 UNC	-	1.13	1.75	.375-16 UNC	1.54	Ø 0.77	0.44	3.0
<b>HCS-50</b>	3.80	3.32	2.95	M65 X 1.5	2.56	1.10	0.55	-	M12 X 1.75	0.87	0.95	1.77	M8 X 1.25	1.77	Ø 0.51	0.47	3.3
<b>CY2754-5</b>	3.63	3.00	-	Ø 3.5	3.13	1.25	0.44	-	.875-9 UNC	-	1.25	2.12	.375-16 UNC	1.61	Ø 0.89	0.44	6.0
<b>MRH-120</b>	2.54	2.20	-	M70 X 1.5	2.76	1.38	0.39	0.19	M18 X 1.5	-	0.60	2.00	M6 X 1.0	0.68	Ø 0.77	0.25	3.1
<b>QDH-120</b>	2.54	2.22	-	2.750-16 UN	2.75	1.38	0.39	0.19	.750-10 UNC	-	0.62	2.00	.312-18 UNC	0.68	Ø 0.77	0.25	3.0
<b>RWH-120</b>	2.54	2.22	-	2.750-16 UN	2.75	1.38	0.39	0.19	.750-16 UNF	-	0.61	2.00	.312-18 UNC	0.68	Ø 0.77	0.25	3.1
<b>RWH-121</b>	4.24	3.22	-	2.750-16 UN	2.75	1.38	0.53	0.19	.750-16 UNF	-	0.73	2.00	.312-18 UNC	0.68	Ø 0.77	0.25	4.8
<b>HCS-80</b>	4.31	3.75	3.35	M75 X 1.5	2.95	1.26	0.67	-	M16 X 2.0	0.94	1.27	2.17	M8 X 1.25	1.97	Ø 0.67	0.47	5.1
<b>RWH-200</b>	5.39	4.88	-	3.875-12 UN	3.88	2.12	0.75	0.19	Ø 1.06	-	0.88	3.25	.375-16 UNC	1.50	Ø 1.06	0.38	13.6
<b>RWH-202</b>	8.39	6.37	-	3.875-12 UN	3.88	2.12	0.75	0.19	Ø 1.06	-	0.88	3.25	.375-16 UNC	1.50	Ø 1.06	0.38	17.0
<b>HCS-110</b>	4.74	4.11	3.66	M90 X 2.0	3.54	1.57	0.75	-	M20 X 2.5	1.26	1.44	2.56	M10 X 1.5	2.36	Ø 0.83	0.59	7.9
<b>RWH-300</b>	5.52	5.02	-	4.500-12 UN	4.49	2.54	0.85	0.19	Ø 1.31	-	0.88	3.62	.375-16 UNC	1.66	Ø 1.31	0.62	19.0
<b>RWH-301</b>	6.52	5.52	-	4.500-12 UN	4.49	2.54	0.85	0.19	Ø 1.31	-	0.88	3.62	.375-16 UNC	1.66	Ø 1.31	0.62	21.5
<b>RWH-302</b>	9.52	7.03	-	4.500-12 UN	4.49	2.54	0.85	0.19	Ø 1.31	-	0.88	3.62	.375-16 UNC	1.66	Ø 1.31	0.62	24.0

<sup>1)</sup> For these models G1 = manifold and .125-27 NPTF

Linear cylinders  
Power sources  
Valves  
Pallet components  
System components  
Yellow pages

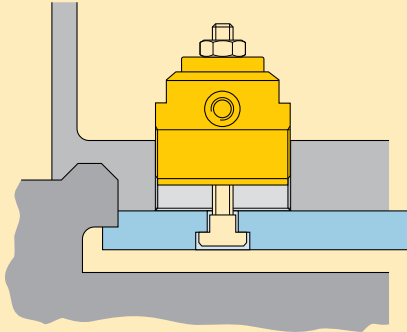
# Positive clamping cylinder *Application & selection*

Shown: MRS-1, MRS-1001, MRS-5001



▶ These cylinders are designed for prolonged clamping applications in moveable machine parts, tools, fixtures, pallets and workpieces.

The mechanical clamping force of this cylinder is ideal for FMS applications. Hydraulic pressure is used to release the workpiece and is not required to maintain the clamping force on the workpiece. Internal high strength springs produce the required clamping force.



■ When pressure is released, the Enerpac MRS cylinders clamp the workpiece by pushing it against the frame that is attached to the fixture.

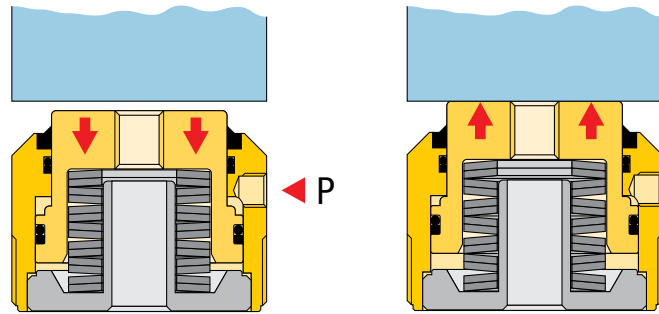
## Ideal for palletized applications

- Heavy disk springs maintain the clamping force - hydraulic pressure is used for release
- Single-acting design allows easy setup of hydraulic system
- Hollow plunger design allows easy retrofit for mechanical clamping
- Custom buttons can be fitted into the plunger for clamping directly against a workpiece
- Threaded body allows easy cylinders mounting directly into fixture plate
- Internal threaded plunger allows accessories to be used easily for retrofit applications

## i Positive clamping operation

The applied clamping force is determined by how far the cylinder's plunger is being retracted when engaging contact with the workpiece (referred to as the effective clamping stroke).

Use the diagrams on the next page as a guide to your fixture set-up. Note that in order to load and unload the workpiece, the plunger must be retracted somewhat further than the effective clamping stroke.



### Hydraulic pressure applied

- Plunger retracts
- Work piece is released
- New work piece is loaded

### Hydraulic pressure released

- Springs apply force
- Workpiece is clamped
- Machining can take place

## Product selection

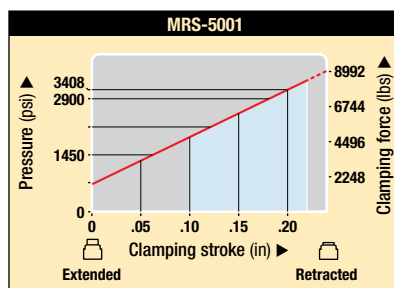
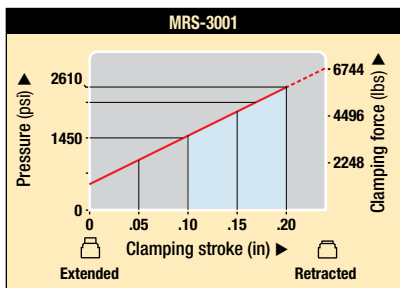
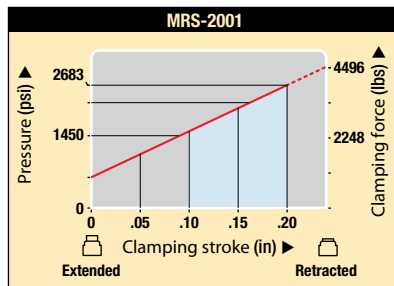
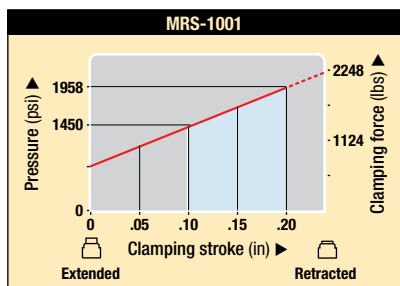
Cylinder capacity at 5000 psi	Effective clamping stroke	Model number	Required operating pressure <sup>1)</sup>	Max. tensioning stroke	Oil capacity
lbs	in		psi	in	in <sup>3</sup>
2700	.09	<b>MRS-1</b>	5000	.09	.05
6000	.09	<b>MRS-2</b>	5000	.09	.26
11,500	.09	<b>MRS-5</b>	5000	.09	.50
1900	.10	<b>MRS-1001</b>	2000	.20	.54
3700	.10	<b>MRS-2001</b>	2700	.20	.73
5800	.10	<b>MRS-3001</b>	2600	.20	1.22
8500	.12	<b>MRS-5001</b>	3400	.22	1.35

<sup>1)</sup> Minimum operating pressure to fully retract the plunger.  
**Note:** Seal material Buna-N, Polyurethane.

Collet-Lok® product line  
Swing clamps  
Work supports  
Linear clamps

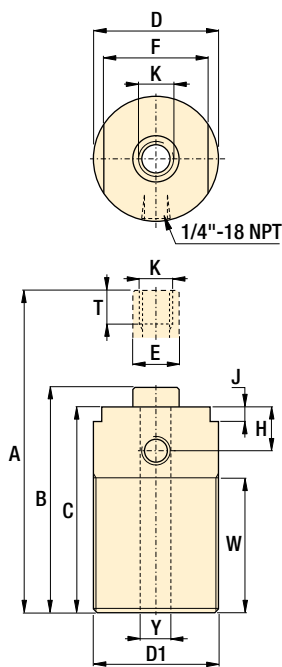


**Stroke/force diagrams** for MRS-1001, -2001, -3001, -5001

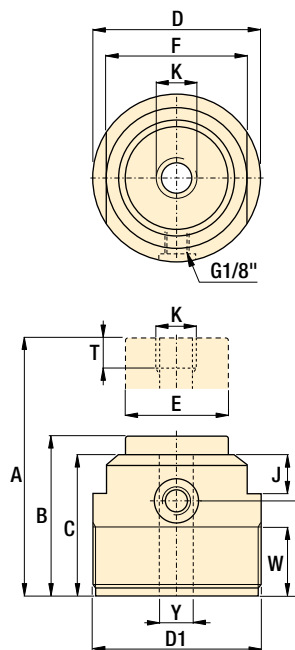


■ = Suggested Clamping Range

**MRS-1, 2, 5**



**other MRS models**



**Product dimensions** in inches [ ]

Model number	A	B	C	D	D1	E	F	H	J	K	T	W	Y	lbs
MRS-1	3.35	3.26	3.11	1.42	M36 x 1,5	.50	1.18	.71	.24	M8 x 1,25	1.42	1.97	.35	1.1
MRS-2	3.54	3.46	3.31	1.89	M48 x 1,5	.68	1.57	.79	.28	M10 x 1,50	1.50	1.97	.43	2.0
MRS-5	4.92	4.83	4.69	2.36	M60 x 2,0	.87	1.97	.83	.28	M16 x 2,0	1.57	3.35	.67	4.0
MRS-1001	2.44	2.24	2.09	2.56	M65 x 1,5	1.57	2.17	1.38	.59	M12 x 1,75	.79	.98	.51	2.6
MRS-2001	2.56	2.36	2.24	3.15	M80 x 2,0	2.16	2.56	1.50	.59	M16 x 2,0	.79	1.14	.67	4.6
MRS-3001	2.91	2.72	2.60	3.74	M95 x 2,0	2.36	3.15	1.81	.67	M20 x 2,5	.79	1.46	.83	6.6
MRS-5001	3.78	3.56	2.66	3.74	M95 x 2,0	2.36	3.15	1.81	.67	M20 x 2,5	.79	1.46	.83	7.7

- Force: 1900-11,500 lbs
- Stroke: .09-.22 inch
- Pressure: 2000-5000 psi

- E** Cilindros de amarre
- F** Vérins de bridage positif
- D** Federspannzylinder



**Options**

**Contact bolts** 86 ▶

**Flange nuts** 86 ▶

**Collet-Lok® work supports** 16 ▶

**Important**

Be sure to refer to the force/stroke chart when selecting cylinders for an application. Piece parts with a large variation at the clamping point may be prone to having variations in clamping force.

Depending on the cycle usage of the application and amount of deflection, the internal disk springs may need to be replaced at scheduled intervals.

# Universal cylinders - Single acting *Application & selection*

Shown: RW-50, RW-104

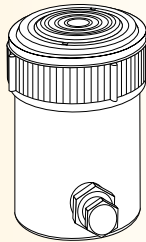


Used when high cylinder forces or long strokes are required in a confined area. Can handle a wide range of production tooling applications.

## Block and cylindrical models

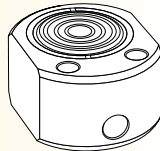
### Cylindrical models

- Long stroke
- Flexible in fixture design
- Variety of attachments



### Block models

- Easily mounted
- Compact design



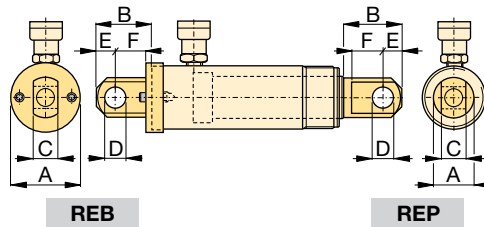
Enerpac RW-101 cylinders used in a high pressure toggle style clamping set-up.



## Heavy-duty cylinders

...handle a variety of applications

- High pressure design when additional force is required
- Long stroke lengths in a compact design, well suited for welding applications
- Collar mounting threads and base mounting holes allow flexible mounting options
- Cylinders are provided with hardened saddles for additional plunger protection
- Snap-in saddles are easily removed for adapting to different plunger devices
- Chrome plated plunger with bronze upper and lower bearing provides a long cylinder life



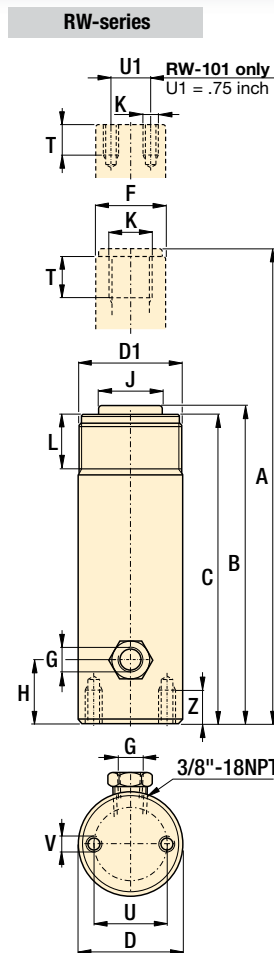
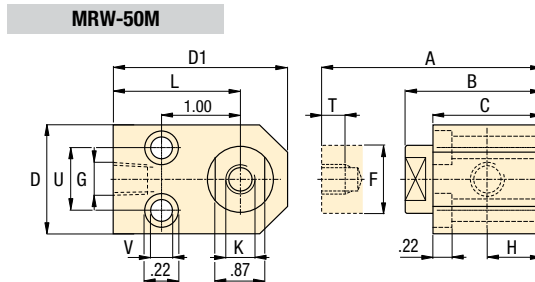
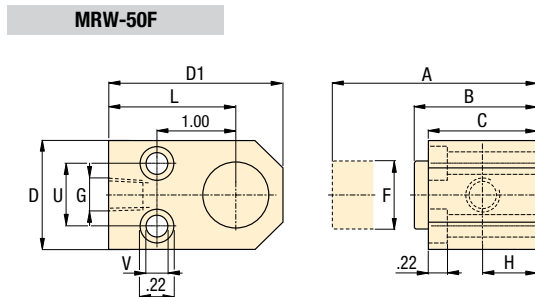
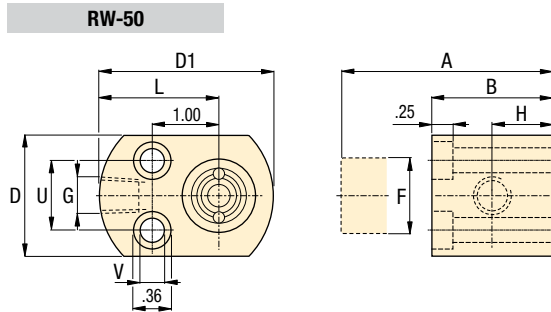
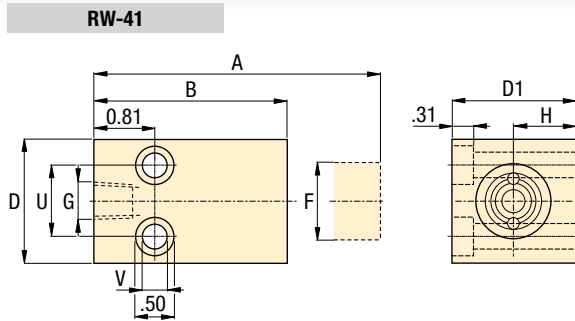
Type	Model number	Clevis eye dimensions (in)						Pin to pin* in
		A	B	C	D	E	F	
Base <sup>1)</sup>	REB-5	1.75	1.88	.56	.63	.63	1.00	2.37
	REB-10	2.50	2.63	1.00	.88	1.00	1.38	3.07
Plunger	REP-5	1.13	1.62	.56	.63	.63	.75	—
	REP-10	1.69	2.43	1.00	.88	1.00	1.13	—

\* Pin to Pin- REB and REP Clevises fitted. Add cylinder stroke length.  
<sup>1)</sup> Mounting screws are included.

## Product selection

Cylinder capacity at 5000 psi	Stroke	Model number	Effective area	Oil capacity	Operating pressure
<b>▼ Block models</b>					
4970	0.62	RW-41	0.99	0.62	85-8000
4970	0.62	RW-50	0.99	0.62	600-10,000
4970	0.59	MRW-50F	0.99	0.62	85-10,000
4970	0.59	MRW-50M	0.99	0.62	85-10,000
<b>▼ Cylindrical models</b>					
4970	1.01	RW-51	0.99	0.99	600-10,000
4970	3.17	RW-53	0.99	2.97	600-10,000
4970	5.17	RW-55	0.99	4.95	600-10,000
11,180	0.99	RW-101	2.23	2.23	600-10,000
11,180	2.18	RW-102	2.23	4.75	600-10,000
11,180	4.18	RW-104	2.23	9.21	600-10,000
11,180	6.11	RW-106	2.23	13.67	600-10,000
11,180	10.13	RW-1010	2.23	22.59	600-10,000

Note: Seal material Buna-N, Polyurethan.



- Force: 4970-11,180 lbs
- Stroke: .59-10.13 inch
- Pressure: 600-5000 psi

- E** Cilindros universales
- F** Vérins universels
- D** Universelle Linearzylinder



**Options**

Cylinder accessories

86 ▶



**Important**

These cylinders are intended for medium cycle applications. The return spring is intended for retracting the plunger and heavy devices should not be attached to it.

Plungers should be shielded in welding applications to prevent splatter from sticking to chrome plating.

Do not use these cylinders continuously at full stroke or damage to return spring may result.

**Product dimensions in inches** [ ]

Model number	A	B	C	D	D1	F	G	H	J	K	L	T	U	V	Z	lbs
<b>▼ Block models</b>																
RW-41	3.18	2.56	-	1.62	1.62	1.00	.250-18	0.81	-	-	-	-	1.00	0.35	-	1.8
RW-50	2.24	1.62	-	1.62	2.32	1.00	.375-18	0.75	-	-	1.50	-	1.12	0.22	-	1.8
MRW-50F	2.20	1.61	1.61	1.62	2.56	1.00	.375-18	0.81	-	-	1.75	-	1.12	0.22	-	1.8
MRW-50M	2.60	2.01	1.61	1.62	2.56	1.00	.375-18	0.81	-	M8x1,25	1.75	0.24	1.12	0.22	-	1.8
<b>▼ Cylindrical models</b>																
RW-51	5.42	4.41	4.09	1.50	1.500-16 UN	1.00	.250-18	0.75	1	.750-16 UNF	1.18	0.61	1.00	.250-20 UNC	0.55	2.1
RW-53	9.73	6.56	6.25	1.50	1.500-16 UN	1.00	.250-18	0.75	1	.750-16 UNF	1.18	0.61	1.00	.250-20 UNC	0.55	3.1
RW-55	13.74	8.57	8.25	1.50	1.500-16 UN	1.00	.250-18	0.75	1	.750-16 UNF	1.18	0.61	1.00	.250-20 UNC	0.55	3.9
RW-101	4.53	3.54	3.41	2.25	2.250-14 UNS	1.50	.250-18	0.75	-	#10-24 UNC	1.15	0.24	1.56	.312-18 UNC	0.49	3.8
RW-102	6.97	4.79	4.53	2.25	2.250-14 UNS	1.50	.250-18	0.75	1.38	1.000-8 UNC	1.15	0.68	1.56	.312-18 UNC	0.49	4.9
RW-104	10.97	6.79	6.53	2.25	2.250-14 UNS	1.50	.250-18	0.75	1.38	1.000-8 UNC	1.15	0.68	1.56	.312-18 UNC	0.49	7.0
RW-106	15.82	9.71	9.5	2.25	2.250-14 UNS	1.50	.250-18	0.75	1.38	1.000-8 UNC	1.15	0.68	1.56	.312-18 UNC	0.49	9.6
RW-1010	23.88	13.75	13.50	2.25	2.250-14UN	1.50	.250-18	0.75	1.38	1.000-18UN	1.13	0.75	1.56	.312-18un	0.50	13.8

# Universal cylinders - Double acting *Application & selection*

Shown: RD-2510, RD-96, RD-256, RD-41, RD-166



Used when high cylinder forces with a powered return stroke is required in a confined area.

Cylinders can push or pull a workpiece into position and the threaded plunger allows adapting standard clevis attachments.

Clamping application using Enerpac RD cylinders (with clevis eye attachments on both ends) for their high pressure capability and mounting flexibility.

Collet-Lok® product line  
Swing clamps  
Work supports  
Linear clamps

## Heavy-duty cylinders

...provide push as well as pull forces

- High pressure design when additional force is required for push or pull applications
- Long strokes in a compact design are well suited for custom toggle style clamping
- Various features for mounting
- Threaded plunger allows a wide range of mounting adapter devices
- Chrome plated plunger provides a long cylinder life

## Optional cylinder attachments

For added cylinder flexibility, a selection of interchangeable mountings is available to fit plunger or cylinder threads.



### Foot mounting

Mounts onto cylinder collar thread. Retainer nut included. Mounting screws not included.



### Flange mounting

Mounts onto cylinder collar thread. Retainer nut included. Mounting screws not included.



### Retainer nut

Locking foot or flange mountings. Mounts onto cylinder base or collar threads. Included with foot and flange mountings.



### Clevis eye

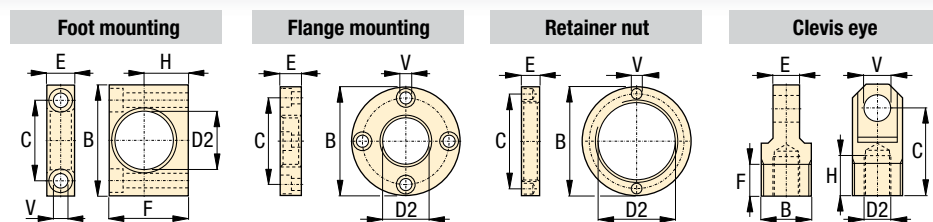
Threads onto plunger or base.

## Product selection

Cylinder capacity at 5000 psi	Stroke		Model number	Effective area		Oil capacity	
	in			in <sup>2</sup>		in <sup>3</sup>	
	push lbs	pull		push	pull	push	pull
3900	1720	1.11	<b>RD-41</b>	.79	.34	.89	.40
3900	1720	3.11	<b>RD-43</b>	.79	.34	2.47	1.10
3900	1720	6.11	<b>RD-46</b>	.79	.34	4.84	2.10
9000	4910	1.15	<b>RD-91</b>	1.77	.98	2.00	1.10
9000	4910	3.15	<b>RD-93</b>	1.77	.98	5.54	3.00
9000	4910	6.15	<b>RD-96</b>	1.77	.98	10.88	6.00
9000	4910	10.15	<b>RD-910</b>	1.77	.98	17.94	9.90
15,500	8300	6.24	<b>RD-166</b>	3.15	1.66	19.67	10.40
15,500	8300	10.24	<b>RD-1610</b>	3.15	1.66	32.26	17.00
24,500	10,750	6.30	<b>RD-256</b>	4.92	2.15	30.73	13.40
24,500	10,750	10.28	<b>RD-2510</b>	4.92	2.15	50.40	22.00



98\_049



**Cylinder attachments in inches** [ ]

Cylinder capacity at		D2	Model number	B	C	E	F	H	V	ø	lbs
5000 psi	10,000 psi										
lbs	lbs										
<b>▼ Foot mounting with retainer nut</b>											
3900	7800	1.38	<b>AD-141</b>	3.00	2.00	0.75	2.25	1.25	0.41	0.9	
9000	18,000	2.00	<b>AD-171</b>	4.00	2.88	1.00	3.25	1.75	0.53	2.6	
15,500	31,000	2.63	<b>AD-181</b>	5.00	3.75	1.38	4.00	2.06	0.78	6.4	
24,500	49,000	3.25	<b>AD-191</b>	6.25	4.62	1.75	4.88	2.50	1.03	9.9	
<b>▼ Flange mounting with retainer nut</b>											
3900	7800	1.38	<b>AD-142</b>	3.88	3.09	0.75	-	-	0.41	2.2	
9000	18,000	2.00	<b>AD-172</b>	4.75	3.88	1.00	-	-	0.41	4.6	
15,500	31,000	2.63	<b>AD-182</b>	5.63	4.56	1.38	-	-	0.53	8.4	
24,500	49,000	3.25	<b>AD-192</b>	6.50	5.34	1.75	-	-	0.66	13.2	
<b>▼ Retainer nut</b>											
3900	7800	1.375-12 UNF	<b>AD-143</b>	2.25	1.81	0.38	-	-	0.25	0.2	
9000	18,000	2.000-12 UN	<b>AD-173</b>	3.00	2.50	0.50	-	-	0.27	0.7	
15,500	31,000	2.625-16 UN	<b>AD-183</b>	3.63	3.13	0.75	-	-	0.27	1.3	
24,500	49,000	3.250-16 UN	<b>AD-193</b>	4.25	3.75	1.00	-	-	0.27	1.8	
<b>▼ Clevis eye</b>											
3900	7800	.500-20 UNF	<b>AD-150</b>	1.125-20 UN	2.06	0.62	0.75	0.94	0.63	0.5	
9000	18,000	.750-16 UNF	<b>AD-151</b>	1.688-18 UNF	2.25	1.00	1.00	0.94	0.75	1.3	
15,500	31,000	1.125-12 UNF	<b>AD-152</b>	2.187-16 UNS	3.06	1.25	1.00	1.19	1.00	2.9	
24,500	49,000	1.500-12 UNF	<b>AD-153</b>	2.750-16 UN	3.06	1.50	1.00	1.06	1.25	4.6	

**Force: 3900-24,500 lbs**

**Stroke: 1.11-10.28 inch**

**Pressure: 500-10,000 psi**

- E** Cilindros universales
- F** Vérins universels
- D** Universelle Linearzylinder



**Options**

**Cylinder accessories**

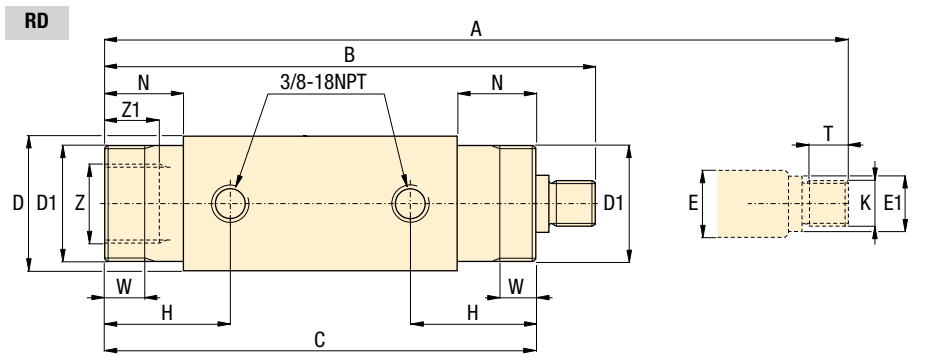
86 ▶

**Important**

**Be certain that the mounting devices can handle forces in the push and pull direction.**

**RD series cylinders are designed for a maximum operating pressure of 10,000 psi.**

**When applying 10,000 psi cylinder capacities double as well.**



**Product dimensions in inches** [ ]

Model number	A	B	C	D	D1	E	E1	H	K	N	T	W	Z	Z1	ø
					UN			UN				UN		lbs	
<b>RD-41</b>	8.41	7.30	6.39	2.00	1.375-12	0.75	0.69	1.85	.500-20	1.14	0.76	0.43	1.125-20	0.47	4.8
<b>RD-43</b>	12.41	9.30	8.39	2.00	1.375-12	0.75	0.69	1.85	.500-20	1.14	0.76	0.43	1.125-20	0.47	6.4
<b>RD-46</b>	18.41	12.30	11.39	2.00	1.375-12	0.75	0.69	1.85	.500-20	1.14	0.76	0.43	1.125-20	0.47	9.0
<b>RD-91</b>	9.93	8.78	7.81	2.50	2.000-12	1.00	0.94	2.27	.750-16	1.50	0.77	0.56	1.688-18	0.63	9.0
<b>RD-93</b>	13.93	10.78	9.81	2.50	2.000-12	1.00	0.94	2.27	.750-16	1.50	0.77	0.56	1.688-18	0.63	11.0
<b>RD-96</b>	19.93	13.78	9.81	2.50	2.000-12	1.00	0.94	2.27	.750-16	1.50	0.77	0.56	1.688-18	0.63	14.0
<b>RD-910</b>	27.93	17.78	16.81	2.50	2.000-12	1.00	0.94	2.27	.750-16	1.50	0.77	0.56	1.688-18	0.63	19.0
<b>RD-166</b>	21.57	15.33	14.13	3.00	2.625-16	1.37	1.26	2.90	1.125-12	2.12	1.00	0.88	2.187-16	1.00	22.0
<b>RD-1610</b>	29.57	19.33	18.13	3.00	2.625-16	1.37	1.26	2.90	1.125-12	2.12	1.00	0.88	2.187-16	1.00	29.0
<b>RD-256</b>	22.98	16.68	15.63	3.54	3.250-16	1.87	1.77	3.50	1.500-12	2.76	0.90	1.12	2.750-16	0.99	36.0
<b>RD-2510</b>	30.95	20.67	19.61	3.54	3.250-16	1.87	1.77	3.50	1.500-12	2.76	0.90	1.12	2.750-16	0.99	46.0

Linear cylinders  
Power sources  
Valves  
Pallet components  
System components  
Yellow pages

# Cylinder accessories

Shown: Cylinder accessories



These accessories are provided so that you can effectively position, mount and actuate Enerpac hydraulic cylinders according to your specific fixturing or production applications.

Enerpac worksupport locked in position using an FN series self-locking flange nut.



## For optimum mounting and fixture flexibility

...to match specific applications

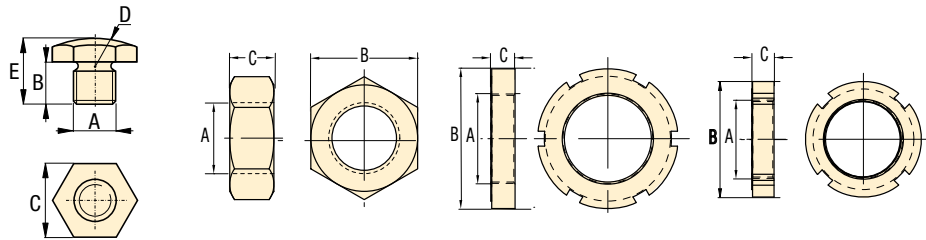
- **Contact bolts**  
Allow cylinders to act as a datum point in your clamping applications, and protect the piston when cylinders are used for pushing applications
- **Cylindrical flange nuts**  
For mounting threaded body cylinders in any position
- **Mounting brackets**  
For bolting cylinders to suit the application

All BS Models

FN-121, 201, 251

FN-48, 55, 65, 80

All Other FN Models

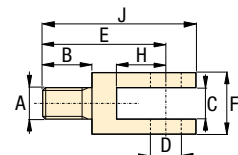


## Product dimensions in inches [ ]

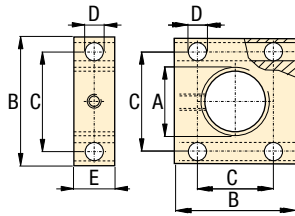
A	Model number	B	C	D	E	A	Model number	B	C
thread		rad.				thread			
<b>▼ Spherical contact bolts</b>									
#6-32 UNC	<b>BS-21</b>	.20	.25	.24	.35	0.500-20 UNF	<b>FN-121</b>	0.75	0.31
#8-32 UNC	<b>BS-41</b>	.28	.31	.31	.43	M12 x 1,5	<b>FN-122</b>	1.10	0.24
M4 x 0,7	<b>BS-42</b>	.28	.31	.31	.43	0.750-16 UNF	<b>FN-201</b>	1.13	0.42
.250-28 UNF	<b>BS-61</b>	.31	.44	.44	.55	M20 x 1,5	<b>FN-202</b>	1.12	0.31
M6 x 1,0	<b>BS-62</b>	.31	.44	.44	.55	1.000-12 UNF	<b>FN-251</b>	1.50	0.55
.313-24 UNF	<b>BS-81</b>	.39	.56	.55	.67	1.125-16 UN	<b>FN-281</b>	1.75	0.39
M8 x 1,25	<b>BS-82</b>	.39	.55	.55	.67	M28 x 1,5	<b>FN-282</b>	1.97	0.39
.375-16 UNC	<b>BS-91</b>	.39	.63	.63	.67	1.250-16 UN	<b>FN-301</b>	1.88	0.39
.500-13 UNC	<b>BS-101</b>	.39	.69	.67	.71	M30 x 1,5	<b>FN-302</b>	1.97	0.39
M10 x 1,5	<b>BS-102</b>	.26	.67	.91	.43	1.313-16 UN	<b>FN-331</b>	1.88	0.25
M16 x 2,0	<b>BS-162</b>	.47	.87	.87	.94	1.375-18 UNF	<b>FN-351</b>	1.88	0.25
M20 x 2,5	<b>BS-202</b>	.47	.94	.87	.94	M35 x 1,5	<b>FN-352</b>	2.17	0.43
<b>▼ Jam nuts</b>									
						1.625-16 UN	<b>FN-421</b>	2.25	0.31
						M42 x 1,5	<b>FN-422</b>	2.44	0.47
						1.875-16 UN	<b>FN-481</b>	2.50	0.51
						M48 x 1,5	<b>FN-482</b>	2.95	0.51
						2.125-16 UN	<b>FN-551</b>	3.13	0.38
						M55 x 1,5	<b>FN-552</b>	3.15	0.51
						2.500-16 UN	<b>FN-651</b>	3.25	0.39
						M65 x 1,5	<b>FN-652</b>	3.74	0.55
						3.125-16 UN	<b>FN-801</b>	4.13	0.51
						M80 x 2,0	<b>FN-802</b>	4.53	0.63

## Product dimensions in inches [ ]

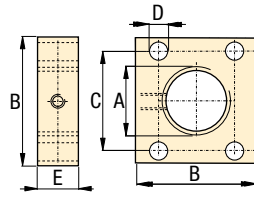
A	Model number	B	C	D	E	F	H	J
thread		ø						
<b>▼ Yoke</b>								
.313-24 UNF	<b>Y-3121</b>	.50	.31	.31	1.25	.63	.50	1.56



**MF and AW-51 models**



**other AW models**



- E** Accesorios de cilindro
- F** Accessoires pour vérins
- D** Zubehör für Zylinder

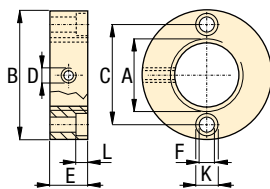
**Product dimensions** in inches [ ]

A thread	Model number	B	C	D ø	E
-------------	-----------------	---	---	--------	---

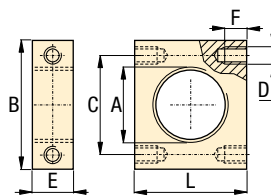
▼ Mounting flanges – Rectangular

1.375-18 UNEF	<b>AW-5</b>	1.75	1.34	0.27	0.50
1.500-16 UN	<b>AW-51</b>	2.25-2.75	1.62-2.12	0.41	1.00
1.875-16 UN	<b>AW-89</b>	2.25	1.77	0.33	1.00
2.500-16 UN	<b>AW-19</b>	3.25	2.17	0.35	0.98
3.125-16 UN	<b>AW-90</b>	3.75x4.75	2.38x3.50	0.64	1.25
0.500-20 UNF	<b>MF-121</b>	1.50	1.00	0.27	1.00
M12 x 1,5	<b>MF-122</b>	1.57	0.98	0.25	0.98
0.750-16 UNF	<b>MF-201</b>	2.25	1.50	0.40	1.50
M20 x 1,5	<b>MF-202</b>	2.56	1.77	0.40	1.57
1.000-12 UNF	<b>MF-251</b>	2.50	1.75	0.40	1.50
1.125-16 UN	<b>MF-281</b>	2.75	2.00	0.40	1.50
M28 x 1,5	<b>MF-282</b>	2.95	1.97	0.40	1.57
1.313-16 UN	<b>MF-331</b>	3.00	2.25	0.40	1.50
1.375-18 UNEF	<b>MF-351</b>	3.00	2.25	0.40	1.50
M35 x 1,5	<b>MF-352</b>	3.15	2.24	0.40	1.57
1.625-16 UN	<b>MF-421</b>	3.25	2.50	0.40	1.50
M42 x 1,5	<b>MF-422</b>	3.54	2.48	0.40	1.57
1.875-16 UN	<b>MF-481</b>	3.50	2.75	0.40	1.50
M48 x 1,5	<b>MF-482</b>	3.74	2.76	0.40	1.57
2.125-16 UN	<b>MF-551</b>	4.00	3.00	0.46	1.75
M55 x 1,5	<b>MF-552</b>	4.33	3.23	0.47	1.77
2.500-16 UN	<b>MF-651</b>	4.50	3.50	0.46	1.75
M65 x 1,5	<b>MF-652</b>	4.53	3.50	0.47	1.77
3.125-16 UN	<b>MF-801</b>	5.00	4.00	0.46	1.75
M80 x 2,0	<b>MF-802</b>	5.31	4.25	0.47	1.77

**AW-53, -121**



**AW-102**



**Product dimensions** in inches [ ]

A thread	Model number	B ø	C	D thread	E ø	F ø	K ø	L
-------------	-----------------	--------	---	-------------	--------	--------	--------	---

▼ Mounting flanges – Cylindrical

1.500-16 UN	<b>AW-53</b>	2.88	2.25	.250-20 UNC	.75	.28	.41	0.31
2.750-16 UN	<b>AW-121</b>	4.50	3.63	.250-20 UNC	.75	.34	.50	.38

▼ Mounting flanges – Rectangular

2.250-14 UNS	<b>AW-102</b>	4.00	3.00	.438-20 UNF	1.25	.62	–	3.25
--------------	---------------	------	------	-------------	------	-----	---	------

# 5000 psi Tie Rod Cylinders

Shown: TRFM-1506, TRFL-3210 and TRCM-3206



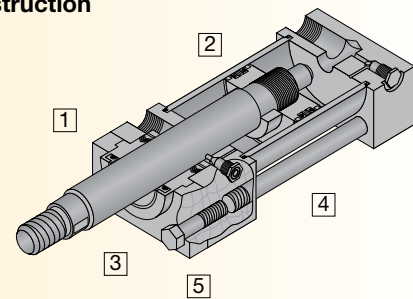
**Enerpac 5000 psi Tie Rod cylinders provide a variety of mounting options for pushing and positioning workpieces and fixtures on a machine. Enerpac tie rod cylinders are designed to the highest industry standards to provide long life and worry-free performance in the most demanding applications.**

## Performance tested design features at 5000 psi

- Rod seal (1) uses spring loaded multiple lip vee rings, a supporting bronze bearing ring bushing and a double lip wiper
- Piston seal (2) combines two bi-directional sealing cast iron piston rings with two block vee seals with back-up rings
- Hardened chrome plated piston rod (3) resists scoring and corrosion, assuring maximum life
- Steel tubing barrel (4), honed to a fine finish assures superior sealing, minimum friction and maximum seal life
- Rod bushing and seals can be serviced by merely removing the retainer plate (5) on most models

### Tie Rod cylinder construction

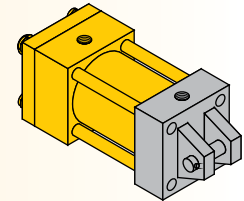
- 1 Rod Seal
- 2 Piston Seal
- 3 Piston Rod
- 4 Barrel
- 5 Retainer Plate



## Tie Rod cylinder mounting styles

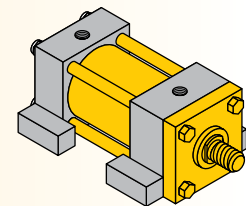
### Clevis Mount – TRCM Series

- NFPA style MP1
- Allows cylinder to pivot
- Requires provision for pivoting on rod end



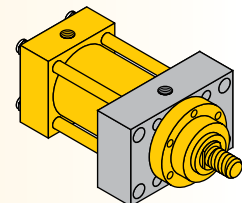
### Foot mount – TRFM series

- NFPA style MS2
- Allows easy mounting with only four bolts
- Backup key included in design to ensure long life



### Flange mount – TRFL series

- NFPA style ME5
- Allows cylinder length to be buried in machine
- Strongest, most rigid mount



## Standard bore sizes

Bore diameter in	Rod diameter in	Capacity at 5000 psi		Effective area	
		Push lbs	Pull lbs	Push in <sup>2</sup>	Pull in <sup>2</sup>
1.50	1.00	8,850	4,900	1.77	0.98
2.00	1.38	15,700	8,300	3.14	1.66
2.50	1.75	24,550	12,500	4.91	2.50
3.25	2.00	41,500	25,800	8.30	5.16
4.00	2.50	62,850	38,300	12.57	7.66

## Additional bore sizes

Bore diameter in	Rod diameter in	Capacity at 5000 psi	
		Push lbs	Pull lbs
5.00	3.50	98,170	50,060
6.00	4.00	141,400	78,550
7.00	5.00	192,400	94,220
8.00	5.50	251,400	132,600

Contact Enerpac for ordering information on additional bore sizes.



## Product selection

Piston diameter	Rod diameter	Stroke	Clevis mount	Foot mount	Flange mount
in	in	in			
1.50	1.00	2	TRCM-1502	TRFM-1502	TRFL-1502
1.50	1.00	4	TRCM-1504	TRFM-1504	TRFL-1504
1.50	1.00	6	TRCM-1506	TRFM-1506	TRFL-1506
1.50	1.00	10	TRCM-1510*	TRFM-1510	TRFL-1510
1.50	1.00	12	TRCM-1512*	TRFM-1512	TRFL-1512
2.00	1.38	2	TRCM-2002	TRFM-2002	TRFL-2002
2.00	1.38	4	TRCM-2004	TRFM-2004	TRFL-2004
2.00	1.38	6	TRCM-2006	TRFM-2006	TRFL-2006
2.00	1.38	10	TRCM-2010	TRFM-2010	TRFL-2010
2.00	1.38	12	TRCM-2012	TRFM-2012	TRFL-2012
2.50	1.75	2	TRCM-2502	TRFM-2502	TRFL-2502
2.50	1.75	4	TRCM-2504	TRFM-2504	TRFL-2504
2.50	1.75	6	TRCM-2506	TRFM-2506	TRFL-2506
2.50	1.75	10	TRCM-2510	TRFM-2510	TRFL-2510
2.50	1.75	12	TRCM-2512	TRFM-2512	TRFL-2512
3.25	2.00	2	TRCM-3202	TRFM-3202	TRFL-3202
3.25	2.00	4	TRCM-3204	TRFM-3204	TRFL-3204
3.25	2.00	6	TRCM-3206	TRFM-3206	TRFL-3206
3.25	2.00	10	TRCM-3210	TRFM-3210	TRFL-3210
3.25	2.00	12	TRCM-3212	TRFM-3212	TRFL-3212
4.00	2.50	2	TRCM-4002	TRFM-4002	TRFL-4002
4.00	2.50	4	TRCM-4004	TRFM-4004	TRFL-4004
4.00	2.50	6	TRCM-4006	TRFM-4006	TRFL-4006
4.00	2.50	10	TRCM-4010	TRFM-4010	TRFL-4010
4.00	2.50	12	TRCM-4012	TRFM-4012	TRFL-4012

Cushions are available for all cylinder models. Cushions slow down heavy loads prior to end of stroke, preventing damage to the cylinder of the machine. To add cushions to your Enerpac Tie Rod cylinder, simply add the letter "C" to the end of any model number. Note: the addition of cushions does not affect the outside dimensions of the cylinder.

\* These models are only rated to 4000 psi due to constraints on the mechanical properties of the rod.

## Custom build your Tie Rod cylinder

TR	CM	15	12	C
1	2	3	4	5
<b>1 Product Type</b> TR = Tie Rod		<b>3 Bore Diameter</b> 15 = 1.5" 20 = 2.0" 25 = 2.5" 32 = 3.25" 40 = 4.0"	<b>4 Stroke</b> 02 = 2" 04 = 4" 06 = 6" 10 = 10" 12 = 12"	<b>5 Cushions</b> Blank = None C = Cushions both ends
<b>2 Mounting</b> CM = Clevis Mount FM = Foot Mount FL = Flange Mount				

## Seal and repair kits

Seal kits include piston, rod and barrel seals. Repair kits include seal kit plus rod bushing and rear bearing ring.

## Product dimensions in inches

Bore diameter in	Rod diameter in	Seal kit	Repair kit
1.50	1.00	TR15SK	TR15RK
2.00	1.38	TR20SK	TR20RK
2.50	1.75	TR25SK	TR25RK
3.25	2.00	TR32SK	TR32RK
4.00	2.50	TR40SK	TR40RK

Force: 8850-62,850 lbs.

Stroke: 2-12 inches

Pressure: 500-5000 psi

**E** Cilindros Atirantados

**F** Vérins à tirants

**D** Zugankerzylinder

## Options

### Accessories

93 ▶



### ZW Series Pumps

114 ▶



### VP Series Valves

136 ▶



### Fittings

194 ▶



## Important

Consult individual product selection pages for application and installation criteria specific to each mounting style. If you are unsure of an application, contact Enerpac directly.

Enerpac can provide many other tie rod cylinders in a wide variety of mounting styles, bore and stroke sizes. Contact Enerpac directly and talk to our Custom Products group for a quotation.

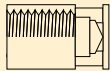
Shown: TRCM-3204



## TR series clevis mount

Enerpac clevis mount 5000 psi Tie Rod cylinders provide for motion in two axis, increasing the range of motion on your machine with only one cylinder.

## Special rod ends

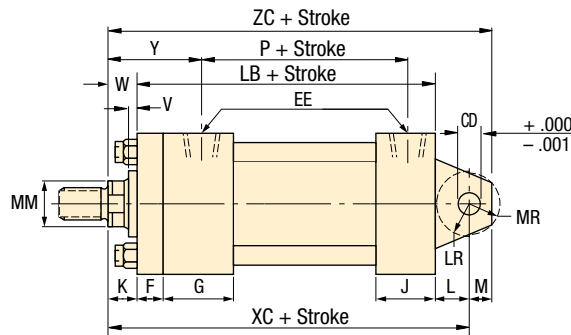
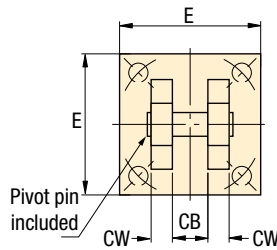


- Either internal or external threads available
- Custom designs to match your tooling requirements

## Flexibility of motion

- Clevis mount cylinders include pivot pin for mounting in your machine
- Standard rod eyes and rod clevises available for each bore size.
- NFPA style MP1
- Designed to carry shear loads
- Pivot pins should be carried by rigidly held bearings and closely fit for the entire length of the pin

TRCM models Clevis mount



Force: 8850-62,850 lbs.

Stroke: 2-12 inches

Pressure: 500-5000 psi

**E** Cilindros Atirantados

**F** Vérins à tirants

**D** Zugankerzylinder

## Options

### Accessories

93 ▶



### ZW Series Pumps

114 ▶



### VP Series Valves

136 ▶



### Fittings

194 ▶



## Dimensions in inches [ ]

Bore diameter	Rod diameter	Model number	A	B	C	CB	CD	CW	D*	E	EE	F	G	J	K
1.50	1.00	TRCM-15xx**	1.13	1.50	0.50	0.75	0.50	0.50	0.88	2.50	SAE #10	0.38	1.75	1.50	0.50
2.00	1.38	TRCM-20xx	1.63	2.00	0.63	1.25	0.75	0.63	1.13	3.00	SAE #10	0.63	1.75	1.50	0.63
2.50	1.75	TRCM-25xx	2.00	2.38	0.75	1.25	0.75	0.63	1.50	3.50	SAE #10	0.63	1.75	1.50	0.63
3.25	2.00	TRCM-32xx	2.25	2.63	0.88	1.50	1.00	0.75	1.69	4.50	SAE #12	0.75	2.00	1.75	0.75
4.00	2.50	TRCM-40xx	3.00	3.13	1.00	2.00	1.38	1.00	2.06	5.00	SAE #12	0.88	2.00	1.75	0.75

\* D = Distance across plunger wrench flats.

\*\* 10 and 12 inch models are rated at only 4000 psi.

Bore diameter	Rod diameter	Model number	KK2	L	LB	LR	M	MM	MR	NA	P	V	W	XC	Y	ZC	lbs
1.50	1.00	TRCM-15xx	3/4"-16	0.75	5.00	0.63	0.50	1.00	0.66	0.97	2.13	0.50	1.00	6.75	2.38	7.25	***
2.00	1.38	TRCM-20xx	1"-14	1.25	5.25	1.13	0.75	1.38	0.94	1.34	2.88	0.38	1.00	7.50	2.63	8.25	***
2.50	1.75	TRCM-25xx	1-1/4"-12	1.25	5.38	1.13	0.75	1.75	0.94	1.70	3.00	0.50	1.25	7.88	2.88	8.63	***
3.25	2.00	TRCM-32xx	1-1/2"-12	1.50	6.25	1.25	1.00	2.00	1.19	1.95	3.59	0.38	1.25	9.00	3.09	10.00	***
4.00	2.50	TRCM-40xx	1-7/8"-12	2.13	6.63	1.88	1.38	2.50	1.38	2.45	3.88	0.38	1.38	10.13	3.31	11.50	***

\*\*\* For product weights, please reference the price list or contact Enerpac customer service for more information.

Collet-Lok® product line  
Swing clamps  
Work supports  
Linear clamps

**Force: 8850-62,850 lbs.**

**Stroke: 2-12 inches**

**Pressure: 500-5000 psi**

**E Cilindros Atirantados**

**F Vérins à tirants**

**D Zugankerzylinder**

## Options

### Accessories

93 ▶



### ZW Series Pumps

114 ▶



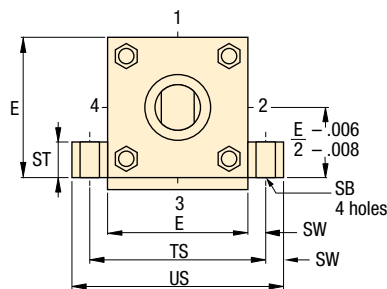
### VP Series Valves

136 ▶



### Fittings

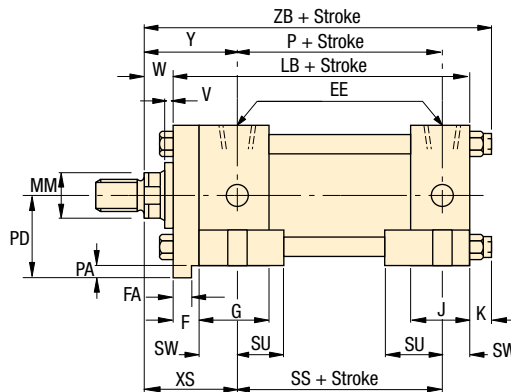
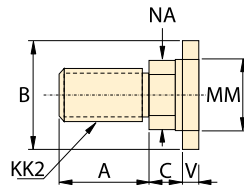
194 ▶



## Ease of installation

- Foot mount cylinders provide simplest mounting option with just four bolt holes required
- Standard key mount is included ensuring proper mounting and adding rigidity
- NFPA style MS2
- Compact mounting fits in tight spaces where other cylinders cannot

TRFM models Foot Mount



## Dimensions in inches [ ]

Bore diameter	Rod diameter	Model number	A	B	C	D*	E	EE	F	FA	G	J	K	KK2	LB	MM
1.50	1.00	TRFM-15xx	1.13	1.50	0.50	0.88	2.50	SAE #10	0.38	0.310-0.312	1.75	1.50	0.50	3/4"-16	5.00	1.00
2.00	1.38	TRFM-20xx	1.63	2.00	0.63	1.13	3.00	SAE #10	0.63	0.560-0.562	1.75	1.50	0.63	1"-14	5.25	1.38
2.50	1.75	TRFM-25xx	2.00	2.38	0.75	1.50	3.50	SAE #10	0.63	0.560-0.562	1.75	1.50	0.63	1-1/4"-12	5.38	1.75
3.25	2.00	TRFM-32xx	2.25	2.63	0.88	1.69	4.50	SAE #12	0.75	0.684-0.687	2.00	1.75	0.75	1-1/2"-12	6.25	2.00
4.00	2.50	TRFM-40xx	3.00	3.13	1.00	2.06	5.00	SAE #12	0.88	0.809-0.812	2.00	1.75	0.75	1-7/8"-12	6.63	2.50

\* D = Distance across plunger wrench flats.

Bore diameter	Rod diameter	Model number	NA	P	PA	PD	SB	SS	ST	SU	SW	TS	US	V	W	XS	Y	ZB	
1.50	1.00	TRFM-15xx	0.97	2.88	0.19	1.44	0.44	3.88	0.50	0.94	0.38	3.25	4.00	0.50	1.00	1.75	2.38	6.50	***
2.00	1.38	TRFM-20xx	1.34	2.88	0.31	1.81	0.56	3.63	0.75	1.25	0.50	4.00	5.00	0.38	1.00	2.13	2.63	6.88	***
2.50	1.75	TRFM-25xx	1.70	3.00	0.31	2.06	0.81	3.38	1.00	1.56	0.69	4.88	6.25	0.50	1.25	2.56	2.88	7.25	***
3.25	2.00	TRFM-32xx	1.95	3.59	0.38	2.63	0.81	4.13	1.00	1.56	0.69	5.88	7.25	0.38	1.25	2.69	3.09	8.25	***
4.00	2.50	TRFM-40xx	2.45	3.88	0.44	2.94	1.06	4.00	1.25	2.00	0.88	6.75	8.50	0.38	1.38	3.13	3.31	8.75	***

\*\*\* For product weights, please reference the price list or contact Enerpac customer service for more information.

Shown: TRFM-1506



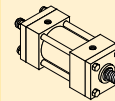
## TR series foot mount

Enerpac foot mount 5000 psi Tie Rod cylinders provide a high quality positioning solution using a minimal amount of space.

## Important

Some custom options may require reduction of working pressure or special installation considerations. Contact Enerpac Technical Service to discuss your application.

## Special rod ends



### Double rod ends

- Available on all models except clevis mounts
- The two rod ends can be different on the same cylinder

98-037

Linear cylinders

Power sources

Valves

Pallet components

System components

Yellow pages

Shown: TRFL-3206



**TR series flange mount**  
Enerpac flange mount 5000 psi Tie Rod cylinders provide the most rigid mounting ensuring long life and high accuracy on your machine.

## Extra strong

- Flange mount is part of the cylinder end cap, providing maximum strength and rigidity
- Allows length of cylinder to be mounted inside the machine
- NFPA style ME5
- Simple four bolt mounting pattern makes installation easy
- Mounting is best suited for tensioning applications

**Force: 8850-62,850 lbs.**

**Stroke: 2-12 inches**

**Pressure: 500-5000 psi**

**E Cilindros Atirantados**

**F Vérins à tirants**

**D Zugankerzylinder**

## Options

### Accessories

86 ▶



### ZW Series Pumps

114 ▶



### VP Series Valves

136 ▶

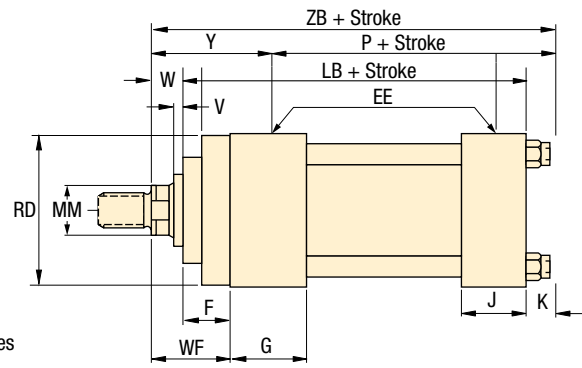
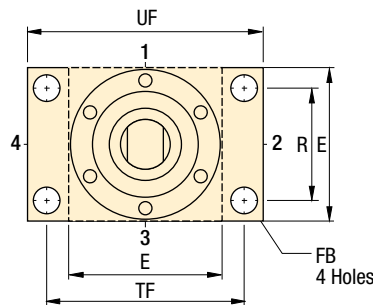
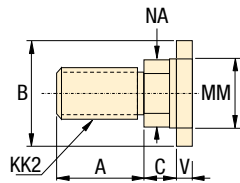


### Fittings

194 ▶



### TRFL models Flange Mount



## Special rod ends

### Rod boots

- Rod boots are made from neoprene coated fabric
- Impervious to oil grease and water
- Rated for temperatures from 0° F to 200° F

### Metallic wipers

- Recommended in applications where contaminants tend to cling to the rod surface
- Available on all rod diameters

## Dimensions in inches [ ]

Bore diameter	Rod diameter	Model number	A	B	C	D*	E	EE	F	FB	G	J	K	KK2
1.50	1.00	TRFL-15xx	1.13	1.50	0.50	0.88	2.50	SAE #10	0.38	0.44	1.75	1.50	0.50	3/4"-16
2.00	1.38	TRFL-20xx	1.63	2.00	0.63	1.13	3.00	SAE #10	0.63	0.56	1.75	1.50	0.63	1"-14
2.50	1.75	TRFL-25xx	2.00	2.38	0.75	1.50	3.50	SAE #10	0.63	0.56	1.75	1.50	0.63	1-1/4"-12
3.25	2.00	TRFL-32xx	2.25	2.63	0.88	1.69	4.50	SAE #12	0.75	0.69	2.00	1.75	0.75	1-1/2"-12
4.00	2.50	TRFL-40xx	3.00	3.13	1.00	2.06	5.00	SAE #12	0.88	0.69	2.00	1.75	0.75	1-7/8"-12

\* D = Distance across plunger wrench flats.

Bore diameter	Rod diameter	Model number	LB	MM	NA	P	R	RD	TF	UF	V	W	WF	Y	ZB	lbs
1.50	1.00	TRFL-15xx	5.00	1.00	0.97	2.88	1.63	-	3.44	4.25	0.50	1.00	1.38	2.38	6.50	***
2.00	1.38	TRFL-20xx	5.25	1.38	1.34	2.88	2.05	-	4.13	5.13	0.38	1.00	1.63	2.63	6.88	***
2.50	1.75	TRFL-25xx	5.38	1.75	1.70	3.00	2.55	-	4.63	5.63	0.50	1.25	1.88	2.88	7.25	***
3.25	2.00	TRFL-32xx	6.25	2.00	1.95	3.59	3.25	4.00	5.88	7.13	0.38	1.25	2.00	3.09	8.25	***
4.00	2.50	TRFL-40xx	6.63	2.50	2.45	3.88	3.82	4.50	6.38	7.63	0.38	1.38	2.25	3.31	8.75	***

\*\*\* For product weights, please reference the price list or contact Enerpac customer service for more information.

Collet-Lok® product line  
Swing clamps  
Work supports  
Linear clamps

## For high production applications

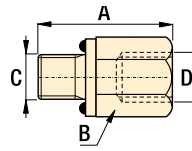
- Fit any style of Enerpac tie-rod cylinder
- Rod eyes and rod clevises
  - Required for proper mounting of TRCM series cylinders
  - Pivot pins supplied separately
- Pivot pins for rod eyes and clevises
  - Provided with cotter pins
  - Must be ordered separately
- Linear alignment coupler
  - Prevents binding caused by misalignment
  - Reduces rod seal and bearing wear

Shown: RRE-15, TRCC-15, TRPP-15, TRAC-15

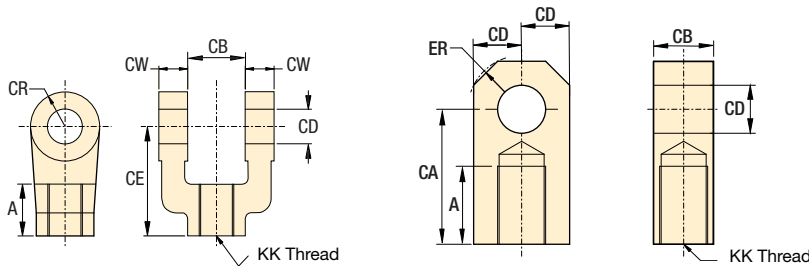


### Fittings dimensions in inches [ ]

From	To	Model number	A	B	C	D
SAE #10	3/8" NPT	<b>FZ2077</b>	1.31	1.00	SAE #10	3/8" NPT
SAE #12	3/8" NPT	<b>FZ2078</b>	1.00	1.25	SAE #12	3/8" NPT
SAE #10	SAE #6	<b>FZ2079</b>	1.26	1.00	SAE #10	SAE #6
SAE #12	SAE #6	<b>FZ2080</b>	1.00	1.25	SAE #12	SAE #6

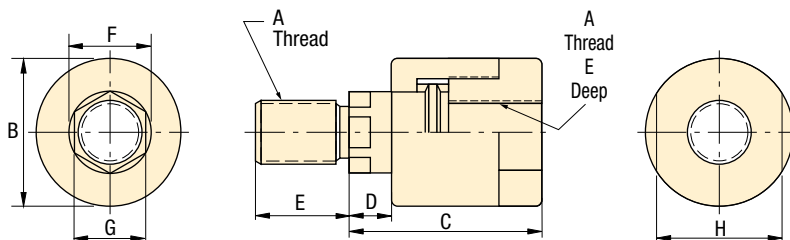


Enerpac 5000 psi Tie-Rod cylinder accessories allow you to complete your design making installation on your machine a simple project.



### Rod Clevis and Rod Eye dimensions in inches [ ]

Rod clevis model number	Rod eye model number	Maximum tension load lbs	KK	A	CA	CB	CD	CE	CR	CW	ER	Clevis Pin
<b>TRRC-15</b>	<b>TRRE-15</b>	12,372	3/4"-16	1.13	2.06	1.25	0.75	2.38	0.75	0.63	0.94	<b>TRPP-15</b>
<b>TRRC-20</b>	<b>TRRE-20</b>	20,433	1"-14	1.63	2.81	1.50	1.00	3.13	1.00	0.75	1.13	<b>TRPP-20</b>
<b>TRRC-25</b>	<b>TRRE-25</b>	30,483	1-1/4"-12	2.00	3.44	2.00	1.38	4.13	1.38	1.00	1.56	<b>TRPP-25</b>
<b>TRRC-32</b>	<b>TRRE-32</b>	49,479	1-1/2"-12	2.25	4.00	2.50	1.75	4.50	1.63	1.25	1.88	<b>TRPP-32</b>
<b>TRRC-40</b>	<b>TRRE-40</b>	70,095	1-7/8"-12	3.00	5.00	2.50	2.00	5.50	2.00	1.25	2.00	<b>TRPP-40</b>



### Linear Alignment Coupler in inches [ ]

Model number	Maximum tension load lbs	A	B	C	D	E	F	G	H
<b>TRAC-15</b>	8500	3/4"-16	1.75	2.31	0.50	1.13	0.97	0.88	1.50
<b>TRAC-20</b>	16,000	1"-14	2.50	2.94	0.50	1.63	1.38	1.16	2.25
<b>TRAC-25</b>	19,500	1-1/4"-12	2.50	2.94	0.50	1.63	1.38	1.16	2.25
<b>TRAC-32</b>	33,500	1-1/2"-12	3.25	4.38	0.81	2.25	1.75	1.50	3.00
<b>TRAC-40</b>	60,000	1-7/8"-12	3.75	5.44	0.88	3.00	2.00	1.88	3.50

## Power sources

### Power sources

Whether you need to run your parts once a day or 24 hours a day, Enerpac has the power source to help you get the job done. Power sources range from simple manual pumps to air operated, to fully customizable electric motor driven units.

With a wide variety of accessories to choose from, Enerpac power units are easily the most versatile and reliable in the industry.




















### Technical support

Refer to the “Yellow Pages” of this catalog for:

- Safety instructions
- Basic hydraulic information
- Advanced hydraulic technology
- FMS (Flexible Machining Systems) technology
- Conversion charts and hydraulic symbols

 197 ▶

	▼ series	▼ page	
Choosing a Pump		96 - 97	
Turbo II air-hydraulic pumps	PA	98 - 101	
Air-hydraulic pumps	ZAJ	102	
Air-hydraulic pumps	PA	103	
Air-hydraulic boosters	AHB, B	104 - 105	
Air valves and accessories	VA, VR RFL	106 - 107	
Economy electric pumps	WU	108 - 109	
Electric submerged pumps and ordering matrix	WE	110 - 113	
Electric pumps and ordering matrix	ZW	114 - 117	
Return line filter kit and heat exchanger kits	ZPF, ZHE	118 - 119	
Level/temp switch and pressure transducer	ZLS ZPT, ZPS	120	
Valve manifold	ZW	121	
Pallet coupling pumps	ZW	122 - 123	
Continuous connection pumps	ZW	124 - 125	
Single station D03 pumps	ZW	126 - 127	
Electric driven workholding pump	ZW5	128 - 131	
Hand pumps	P, SP	132	
Enerpac system solutions		133	

# Choosing a pump

Flow rate: 40-640 in<sup>3</sup>/min

Pressure: 960-10,000 psi

Reservoir: Up to 10 gal

## Options

### Manual valves



▣ 143, 148-151 ▶

### Electric valves



▣ 136-142 ▶

### Air operated valves



▣ 140 ▶

## Important

231 cubic inches = 1 US gal.

61 cubic inches = 1 liter

1 US gallon = 3.785 liters

## Select your pump type

### Air operated pump

Best choice for medium circuits with intermittent or medium duty applications. Air operated pumps have lower flow rates than electric pumps, but are more economical.

▣ 98-103 ▶



### Air hydraulic booster

Best choice for small circuits with intermittent or medium-duty applications. Air hydraulic boosters provide a single shot of oil to your circuit at high pressure.

▣ 104-105 ▶



### Economy electric operated pump

The Economy pump is best suited to power small to medium size fixtures. Its lightweight and compact design makes it ideal for applications which require easy transport of the pump. The universal motor works well on long extension cords.

▣ 108-109 ▶



### Electric submerged pump

Enerpac two stage electric submerged pumps are a quiet, economical workholding power source. Submerged in oil the motor stays cooler when used on an intermittent basis.

▣ 110-113 ▶



### Electric operated pump

Best choice for large circuits with medium or high-duty applications. Electric operated pumps have the highest flow rates available and can be configured with many different accessories.

▣ 114-131 ▶



## Select your pump options

### Reservoir size

Choose a reservoir size that holds enough oil to fill all of your lines, manifolds and cylinders, with enough reserve for future needs. Each Enerpac cylinder has an oil capacity listed on its product page, and each power unit has a reservoir capacity listed.

### Valve type

Directional valves allow you control over what portion of the circuit receives oil. Valves can be operated manually, by electric solenoid or by air pilot pressure. Multiple valves can be used with one power unit to control multiple circuits.

### Accessories

For increased automation, electric pumps can be outfitted with additional accessories, including pressure switches, level switches, and control pendants. These options can either be factory installed or added to an existing power unit in the future.



## **i** Factors to consider when choosing a pump

- ? Is an air or electric pump preferred
- ? How frequently will the pump cycle
- ? Are there size constraints where the pump would be mounted
- ? What is the oil volume of the clamps actuated together in each group
- ? Is there an accumulator? What is the oil volume
- ? Are there sequence valves? What is the setting of the first one
- ? Are the control valves to be controlled by the machine controller

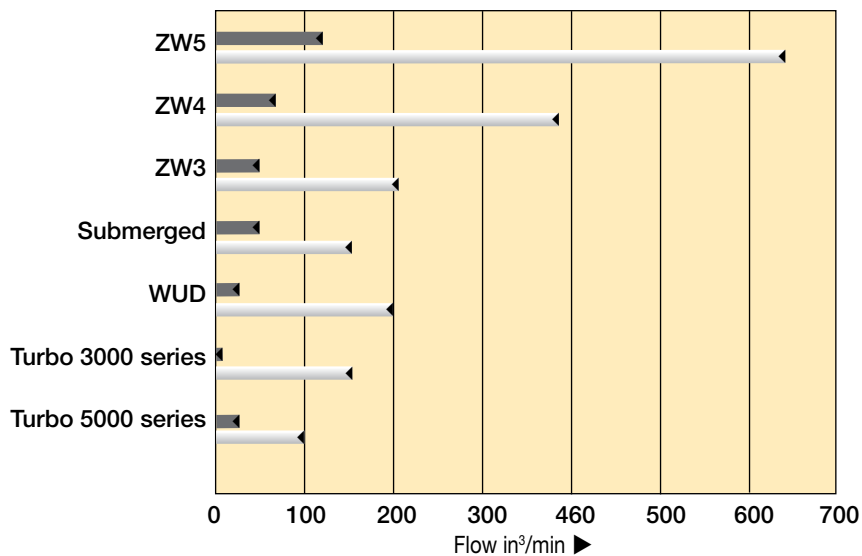
Flow: 40-640 in<sup>3</sup>/min

Pressure: 5000 psi max

Reservoir: up to 10 gallons

## ENERPAC Workholding Pump Comparison Chart

### **i** What flow is right for you?



High Pressure Flow

Low Pressure Flow

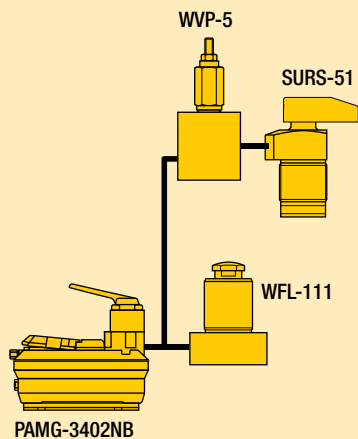
Type of pump	High pressure flow (in <sup>3</sup> /min)	Low pressure flow (in <sup>3</sup> /min)
ZW5	120	640
ZW4	60	380
ZW3	40	205
Submerged	40	150
WUD	20	200
Turbo 3000 series	5	150
Turbo 5000 series	20	100

Shown: PAMG-5402NB, PACG-3102NB, PATG-3102NB, PATG-5105NB



**Turbo II air hydraulic pumps generate the hydraulic pressure you need using the air pressure you have available. The Air Saver Piston reduces air consumption and operating costs.**

They are ideal for providing the power and speed desired in simple clamping circuits. Turbo II air-hydraulic pumps are best suited to medium and lower cycle applications. At only 75 dBA, the Turbo II series helps to keep noise level to a minimum.



## Quick and powerful hydraulic supply in an economical air-powered unit

- On-demand stall-restart operation maintains system pressure, providing clamping security
- External adjustable pressure relief valve (behind sight glass)
- Internal pressure relief valve provides overload protection
- Reduced noise level to 75 dBA
- Operating air pressure: 50-125 psi – enables pump to start at low air pressure\*\*
- Reinforced heavy-duty lightweight reservoir for applications in tough environments
- Five valve mounting options provide flexibility in setup and operation
- Fully serviceable air motor assembly

## Select the required output

### 3000 series

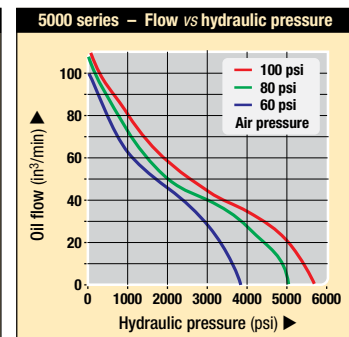
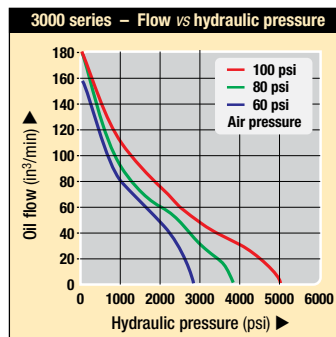
- Hydraulic to air ratio: 45:1

### 5000 series

- Hydraulic to air ratio: 60:1

**\*\* NOTE:** From 50-125 psi air inlet pressure. Performance is significantly diminished below 50 psi. Performance may vary compared to listed values due to seal friction, internal pressure drops and manufacturing tolerances. Be sure to allow some flexibility on air inlet pressure.

## Output oil flow vs pressure

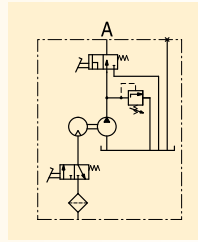


Collet-Lok® product line  
 Swing clamps  
 Work supports  
 Linear clamps  
 Power sources

 **Select the required output:**

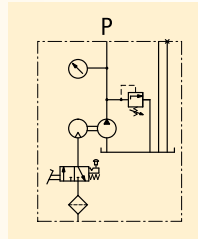
**PATG series**

- Momentary air inlet treadle for operation of single-acting cylinders
- Provides advance, hold and retract functions



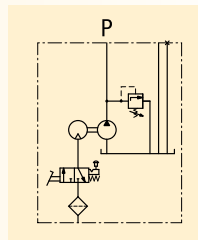
**PACG series**

- Momentary or continuous air inlet treadle
- A remote valve is required for operation of cylinders



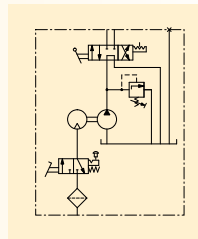
**PASG series**

- Momentary or continuous air inlet treadle
- Suitable for mounting any single- or double-acting valve with a DO3 mounting configuration
- Available with multiple valve manifold (2-gallon only)



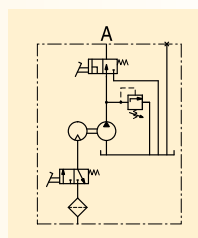
**PAMG series**

- Momentary or continuous air inlet treadle
- Manual 4-way, 3-position, tandem center valve for single- or double-acting operation



**PARG series**

- Includes 15 ft. air pendant for remote control of single-acting cylinders
- Provides advance, hold and retract functions



Oil Flow: 180 in<sup>3</sup>/min

Pressure: 5000 psi max

Sound level: 75 dBA

Air: 12 scfm

Reservoir: 70-462 in<sup>3</sup>

- E** Bombas hidroneumáticas
- F** Pompes hydro-pneumatiques
- D** Lufthydraulische pumpen


 **Options**

Gauges and accessories

 190 ▶



Regulator-filter-lubricator

 106,158 ▶



 **Important**

**For high cycle applications electric pumps are recommended.**



Shown: PACG30S8S-WM10



## 2 Gallon Turbo Pump

The 2 gallon Turbo pump models feature a drawn steel reservoir with an oil level sight glass. Choose from models with a P & T manifold for use with remote mount valves, a single station D03 manifold, the standard treadle or manual 4 way valve models. The PARG series uses an air operated pendant to control the pump functions. Or build a system pump with multiple Enerpac VP valve series, VP03 series or VSS/VST series D03 mount valves. The VMMD series D03 Manual valves can also be used.

All dimensions in inches.

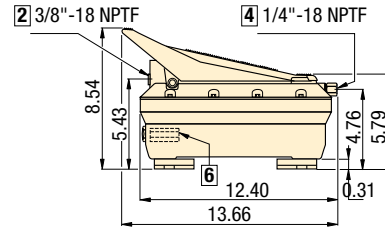
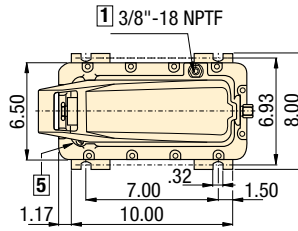
- 1 Auxiliary vent/tank fill port
- 2 Hydraulic output
- 3 Gauge mounting port
- 4 Swivel air input with filter
- 5 Filtered permanent tank vent
- 6 Adjustable pressure relief valve
- 7 Air pendant air input

## Product selection

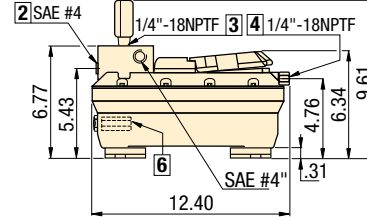
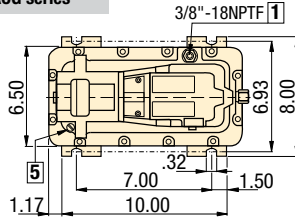
Description	Model numbers 3000 series	Model numbers 5000 series	Usable oil capacity <sup>2)</sup>		Air pressure range	Air consumption	
			horizontal mount	vertical mount			
	180 in <sup>3</sup> min <sup>-1</sup>	120 in <sup>3</sup> min <sup>-1</sup>	in <sup>3</sup>	in <sup>3</sup>	psi	scfm	lbs
<b>▼ Factory supplied valves</b>							
Hand/foot 3-way	PATG-3102NB	PATG-5102NB	127	70	50-125	12	19
Hand 4-way	PAMG-3402NB	PAMG-5402NB	127	70	50-125	12	25
Remote 3-way pendant	PARG-3102NB	PARG-5102NB	127	70	50-125	12	23
<b>▼ User supplied valves</b>							
Remote mount	PACG-3002SB	PACG-5002SB	127	70	50-125	12	19
Pump mount, single DO3 Valve	PASG-3002SB	PASG-5002SB	127	70	50-125	12	19

## 1/2 Gallon reservoir

### PATG series

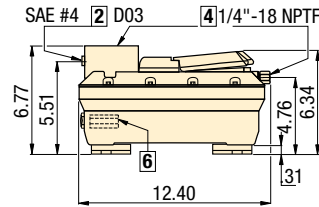
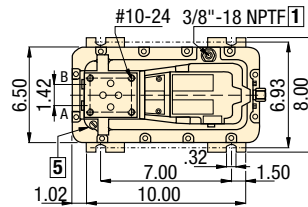


### PACG series

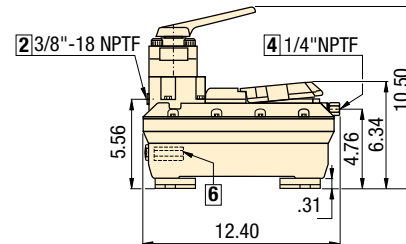
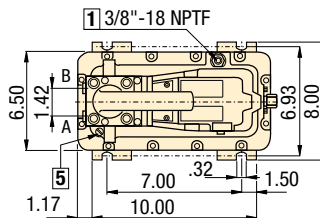


PACG series include pressure gauge G-2517L.

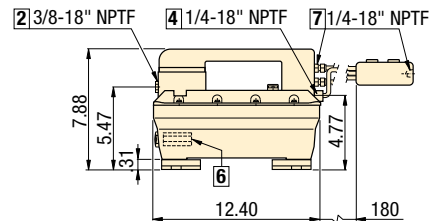
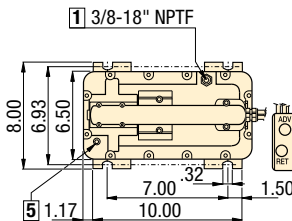
### PASG series



### PAMG series



### PARG series

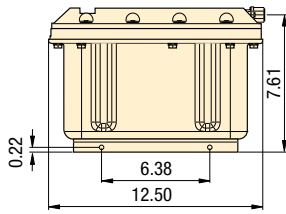


<sup>1)</sup> At 0 psi hydraulic and 100 psi air pressure.  
<sup>2)</sup> Turbo air-hydraulic pumps are also available with 305 in<sup>3</sup> reservoir. To order replace 2 in model number with 5.

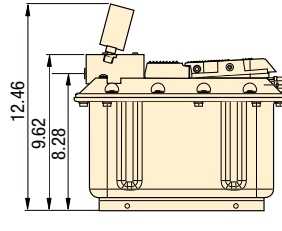
Collet-Lok® product line  
Swing clamps  
Work supports  
Linear clamps  
Power sources

**2-Gallon reservoir**

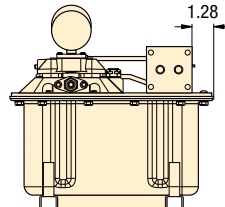
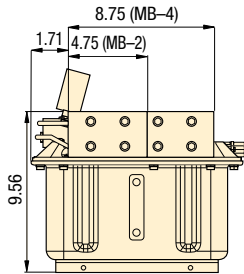
All models



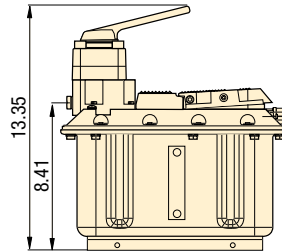
PACG series



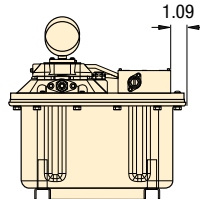
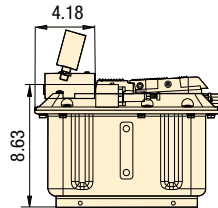
PACG with MB2 or MB4



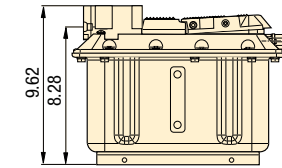
PAMG series



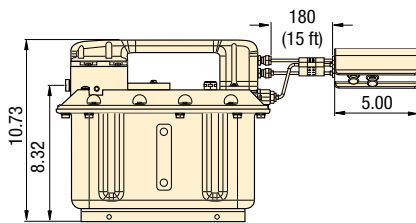
PACG with WM10



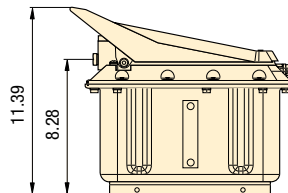
PASG series



PARG series



PATG series



Oil Flow: 180 in<sup>3</sup>/min

Pressure: 5000 psi max

Sound level: 75 dBA

Air: 12 scfm

Reservoir: 70-462 in<sup>3</sup>

- E** Bombas hidroneumáticas
- F** Pompes hydro-pneumatiques
- D** Lufthydraulische pumpen

**Options**

Gauges and accessories

190 ▶



Regulator-filter-lubricator

106,158 ▶



**Product selection**

Description	Model numbers 3000 series	Model numbers 5000 series	Usable oil capacity	Air pressure range	Air consumption	
	180 in <sup>3</sup> min <sup>1)</sup>	120 in <sup>3</sup> min <sup>1)</sup>	in <sup>3</sup>	psi	scfm	lbs
<b>▼ Factory supplied valves</b>						
Hand/foot 3-way	PATG-31S8N	PATG-51S8N	462	50-125	12	54
Hand 4-way	PAMG-34S8N	PAMG-54S8N	462	50-125	12	60
Remote 3-way pendant	PARG-31S8N	PARG-51S8N	462	50-125	12	58
<b>▼ User supplied valves</b>						
Remote mount	PACG-30S8S	PACG-50S8S	462	50-125	12	54
Pump mount, Single DO3 Valve	PASG-30S8S	PASG-50S8S	462	50-125	12	54
Pump mount, Two DO3 Valves	PACG-30S8S-MB2	PACG-50S8S-MB2	462	50-125	12	58
Pump mount, Four DO3 Valves	PACG-30S8S-MB4	PACG-50S8S-MB4	462	50-125	12	61
Pump mount, (1-8) VP Valves	PACG-30S8S-WM10	PACG-50S8S-WM10	462	50-125	12	56

<sup>1)</sup> At 0 psi hydraulic and 100 psi air pressure.

Shown: ZAJ-06505S2C



## ZAJ-065 series air driven pump

These heavy-duty air driven pumps are well suited for use in production applications.

Available with a P & T manifold for use with remote mounted VP, VP03, VSS or VST zero leakage class valves, or with either single or dual pump mounted 2-position/3-way Normally Closed valves 24 VDC solenoid valves.

## Heavy-duty Air Powered Pump

- Suited for use in production applications
- 1-gallon steel reservoir with sight glass, mounting flange

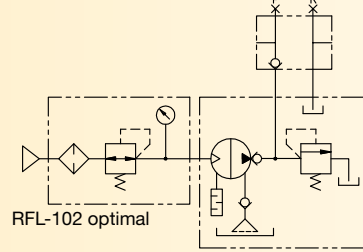
Flow: 124 in<sup>3</sup>/min at 100 psi  
62 in<sup>3</sup>/min at 2000 psi

Pressure: 5000 psi max

- Ⓔ Bombas hidroneumáticas
- Ⓕ Pompes hydro-pneumatiques
- Ⓖ Lufthydraulische pumpen

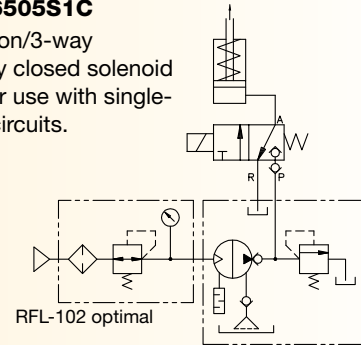
### ZAJ-06505M1

Pressure and tank manifold for use with remote mounted valves.



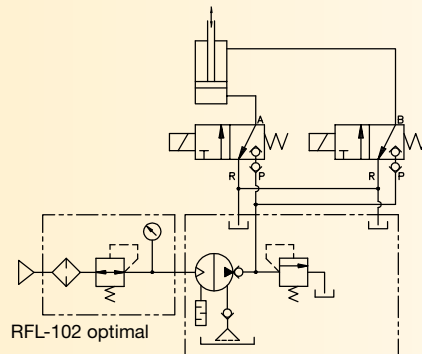
### ZAJ-06505S1C

2-position/3-way normally closed solenoid valve for use with single-acting circuits.



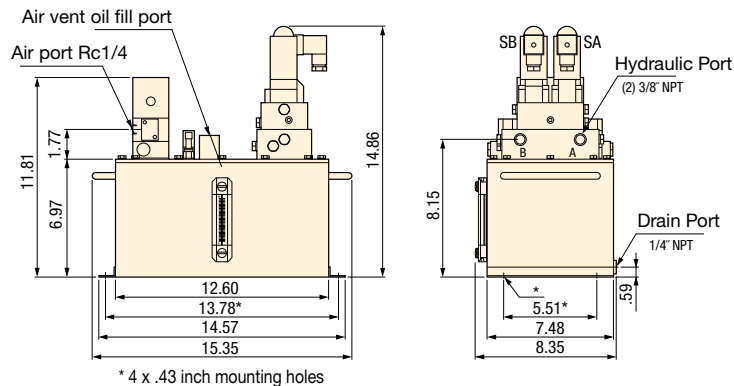
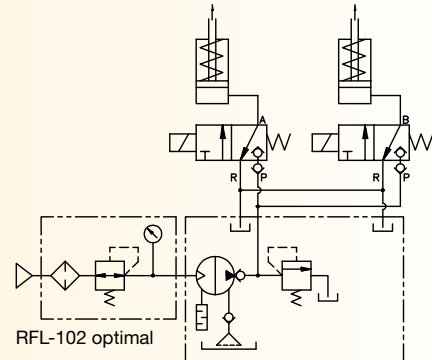
### ZAJ-06505S2C

Dual 2 position/3 way normally closed solenoid valves for use with double-acting circuits.



### ZAJ-06505S2C

Dual 2 position/3 way normally closed solenoid valves for use with two independent single-acting circuits.



Supplied valving	Valve solenoid voltage	Model number	Air pressure range	Oil ports	Air consumption	
					scfm	lbs
Pressure and tank manifold	—	<b>ZAJ-06505M1</b>	15-100	3/8" NPT	18	49
Single 2 pos./3 way solenoid valve	24 VDC	<b>ZAJ-06505S1C</b>	15-100	3/8" NPT	18	49
Dual 2 pos./3 way solenoid valve	24 VDC	<b>ZAJ-06505S2C</b>	15-100	3/8" NPT	18	49

Collet-Lok® product line  
Swing clamps  
Work supports  
Linear clamps  
Power sources

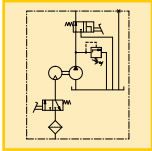
Max. flow: 60-120 in<sup>3</sup>/min

Pressure: 5000 psi max

Air: 12 scfm

Reservoir: 36.6 in<sup>3</sup>

- E** Bombas hidroneumáticas
- F** Pompes hydro-pneumatiques
- D** Lufthydraulische pumpen



## Portable air hydraulic power

- Patented air saver design - minimal air usage for lower cost operation
- Quiet internal air muffler 80 dBa
- 360° swivel oil and air fittings for easier system setup
- External adjustable relief valve
- Built-in 3-way, 2-position valve provides advance-retract cycle operation for single-acting cylinders

Shown: PA-135, -136



## Options

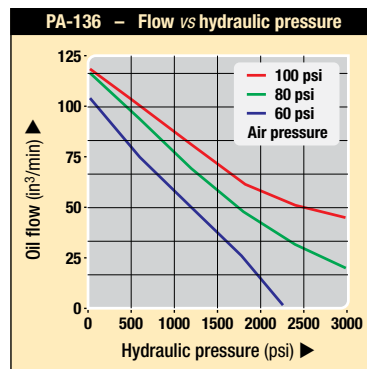
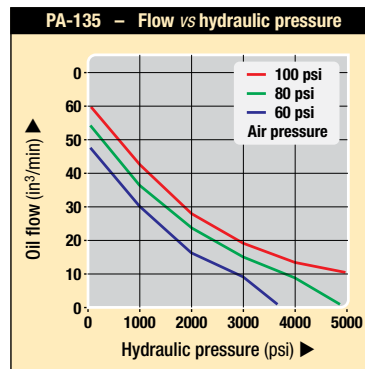
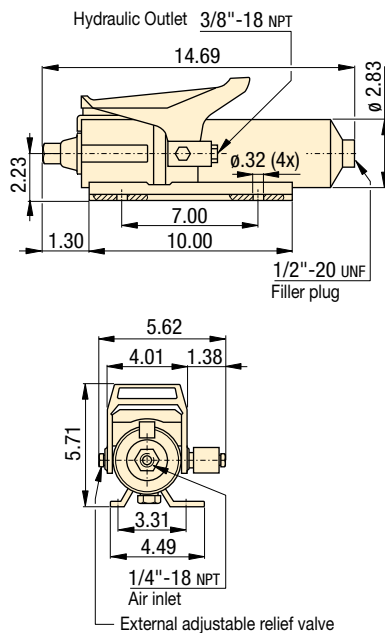
**Regulator-filter-lubricator**

106,158 ▶



**Fittings**

194 ▶



## PA series

Compact, lightweight, air driven power source. Treadle start on pump activates pump operation. Best choice for single-acting cylinders.

These PA series air hydraulic pumps operate in all positions. Here, a PA-135 is mounted vertically to a clamping fixture.



## Product selection

Usable oil capacity	Max. oil flow <sup>1)</sup>	Max. hydraulic pressure	Model number	Valve function	Air pressure range	Air consumption	
in <sup>3</sup>	in <sup>3</sup> /min	psi			psi	scfm	lbs
36.6	60	5000	PA-135	Advance/Retract	60-100	12	14.3
36.6	120	3000	PA-136	Advance/Retract	60-100	12	14.3

<sup>1)</sup> At 0 psi hydraulic pressure.

Note: Seal material: Buna-N, Teflon, Polyurethane.

[www.enerpacwh.com](http://www.enerpacwh.com)

# Air hydraulic boosters *Application & selection*

Shown: AHB-46, B-5003, B-3006



## **AHB and B series boosters**

Large effective area of air piston allows compressed air to generate high output hydraulic pressure.

## For high production applications

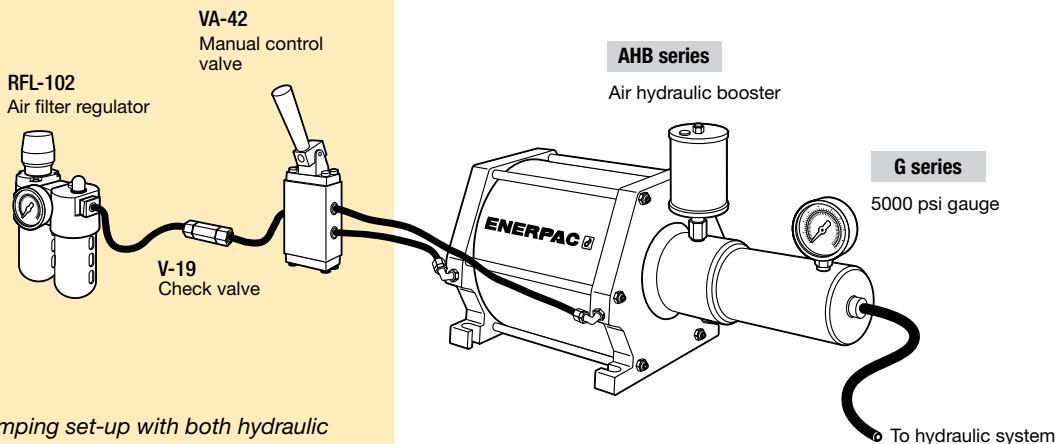
- High speed operation
- Extended service life
- Constant hydraulic output
- Large oil delivery per stroke allows quick filling of cylinders for clamping or punching

### AHB series boosters

- Fiberglass wound air chamber eliminates possibility of rust due to moisture in air system
- Designed for fully automated production applications
- Double-acting, one-shot, high speed operation of air piston

### B series boosters

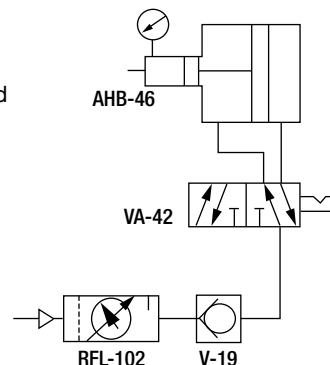
- One-shot spring return
- Steel and cast iron construction
- Built-in stroke sensor for automatic cycle operation  
30 VDC switch closes 1 inch before end of full air piston stroke
- Internal self-bleeding  
Automatically purges air from system when booster piston is at highest point in circuit



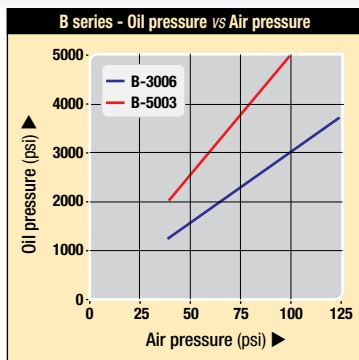
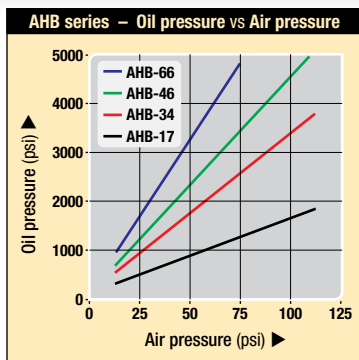
**I** In an automated clamping set-up with both hydraulic and pneumatic components, AHB series boosters are used as a power source for the hydraulic system.

## **i** Hydraulic system schematics

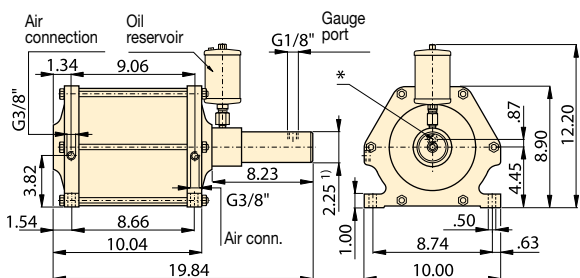
Complete power systems eliminate the guesswork of selecting valves and other system components. Plug in your 15 to 115 psi shop air line and connect your hydraulic components for a total system.





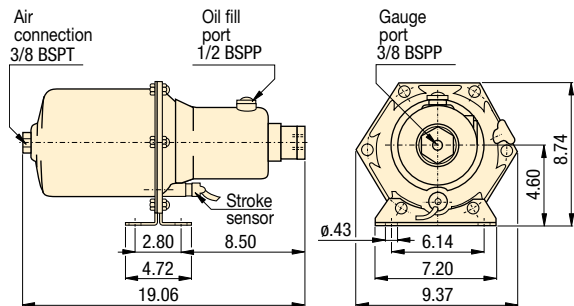


**AHB series**



<sup>1)</sup> Ø 2.83\* for model AHB-17  
 \* Oil connection (G1/4")  
 \*\*\* Adapter to 3/8" NPT air connection is included.  
 NOTE: FZ-2060 Adaptor available for gauge port.

**B series**



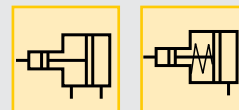
**Selection chart**

Oil pressure		Oil volume per stroke in <sup>3</sup>	Air to oil pressure ratio	Model number	Air consumption per cycle <sup>1)</sup> ft <sup>3</sup> at 85 psi air	Air piston diameter in	Hydraulic piston diameter in	Hydraulic stroke in	Air operating pressure psi	🏋️ lbs
at 75 psi air pressure	at 100 psi air pressure									
<b>▼ AHB series</b>										
1200	1600	18.0	1:16	<b>AHB-17</b>	2.2	8.00	2.00	5.71	15-115	41.4
2550	3460	8.5	1:34	<b>AHB-34</b>	2.2	8.00	1.38	5.71	15-115	37.2
3450	4600	6.1	1:46	<b>AHB-46</b>	2.2	8.00	1.18	5.71	15-115	36.1
4800	-	4.5	1:64	<b>AHB-66</b>	2.2	8.00	1.00	5.71	15-75	35.4
<b>▼ B series</b>										
2250	3000	6.2	1:30	<b>B-3006</b>	.95	7.10	1.22	5.20	40-125	31.0
3750	5000	3.7	1:50	<b>B-5003</b>	.95	7.10	.94	5.20	40-125	31.0

<sup>1)</sup> One cycle = advance + retract stroke.  
 Note: Seal material: Buna-N, Polyurethane.

- Ratio: 1:16-1:64
- Pressure: 1600-5000 psi
- Oil flow: 3.7-18.0 in<sup>3</sup>/stroke
- Air: .95-2.2 scfm/cycle

- E** Multiplicadores
- F** Multiplicateurs
- D** Druckübersetzer



**Options**

**Air valves**

📄 106,158 ▶

**Regulator-filter-lubricator**

📄 106,158 ▶

**Fittings**

📄 194 ▶

**Important**

**Boosters can provide high oil flow rates based on the volume of in-coming air.**  
**Do not exceed the flow rate requirements of the components being used.**

**For vertical mounting of booster, an elbow fitting is recommended for the oil reservoir.**

Shown: VA-42, VAS-42



## Air valves

Enerpac's line of directional air valves and accessories complete your workholding system. Used to control air operated hydraulic units, they increase your productivity and efficiency.

### Application

VA-series directional air valves provide either manual or electric control to air operated hydraulic units. Accessories such as rapid exhaust, check valves, silencers and regulators complete the air control system.

- Accessory valves provide greater safety and more efficient clamping cycles
- Recommended for use with all air powered units
- Directional valves to control booster and pump air supply
- Remote air valve permits either hand or foot operation

## Important

**Valving help**  
See Basic System Set-up and Valve information in our "Yellow Pages".

## To control and regulate air supply

### VA-42 Manual operated air valve 5-way, 2-position

- For control of boosters
- Viton seals standard

### VAS-42 Solenoid operated air valve 5-way, 2-position

- For control of pump and boosters air supply
- Viton seals standard
- Solenoid: 120 VAC, 50/60Hz  
Amperage: inrush .11 Amps, holding .07 Amps
- Maximum cycle rate: 600 cycles per minute

### VR-3 Rapid exhaust valve

- Enables booster to advance and retract faster
- Instantly exhaust air supply from booster to atmosphere

### V-19 Air check valve

- Prevent rapid drop of air pressure to the booster in the event of sudden loss of input air

### RFL-102 Regulator-Filter-Lubricator

- Regulates air pressure
- Filter air input
- Lubricates air motors with a fine oil vapor mist
- Maximum air flow 48 scfm

### HV-1000A Air pilot holding valve

- Holds fluid under pressure offering independent control of different branches of the same fixture
- Valve can control the pilot air and the booster in sequence
- Max. oil flow 305 in<sup>3</sup>/min
- Works with the VA-42 four-way air valve and a booster

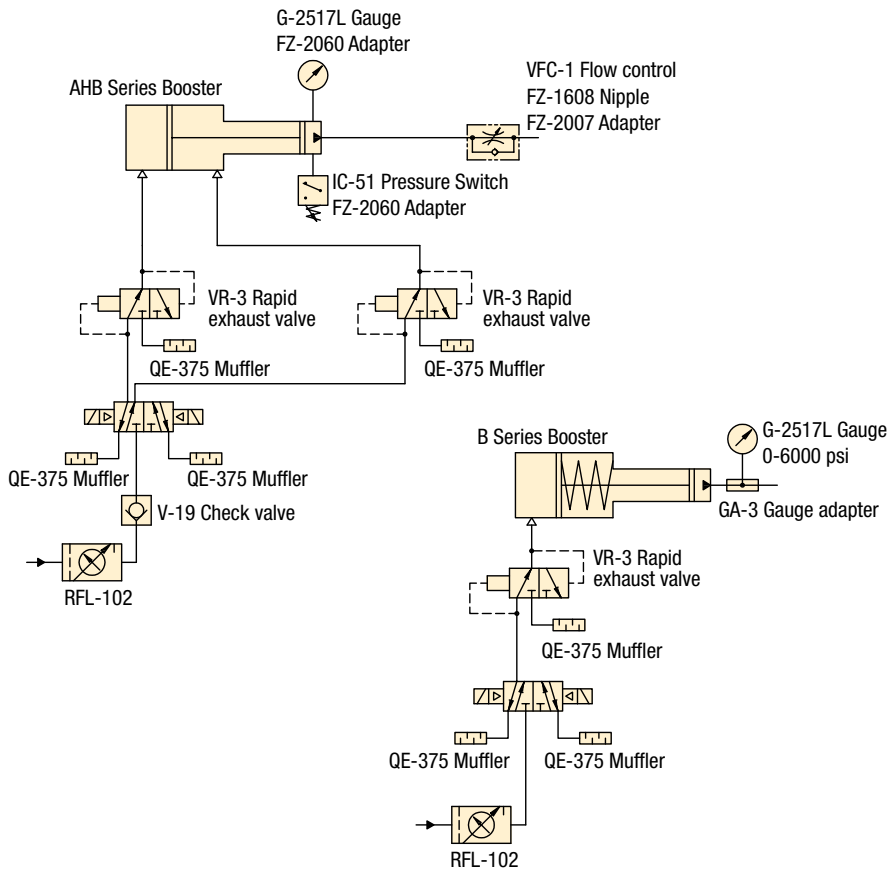
### QE-375 Muffler

- Use with VR-3 or VAS/VA-42
- Reduces noise level of exhaust air from pump

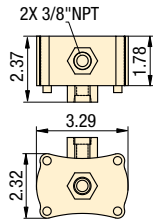
## Product selection

Maximum pressure psi	Model number
<b>▼ Air valves</b>	
30-150	VA-42
30-150	VAS-42
0-100	VR-3
0-100	V-19
<b>▼ Holding Valve</b>	
0-100	HV-1000A*
<b>▼ Accessories</b>	
0-125	RFL-102
0-125	QE-375

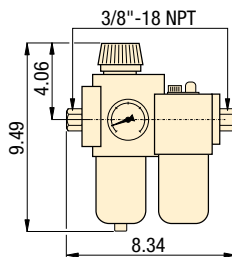
\* Maximum hydraulic pressure: 3000 psi.



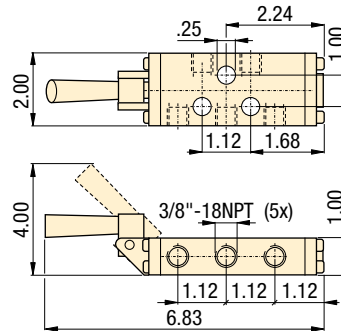
**VR-3**



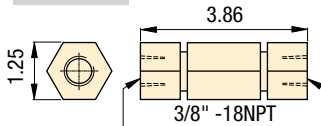
**RFL-102**



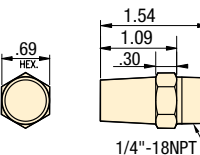
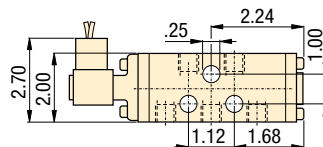
**VA-42**



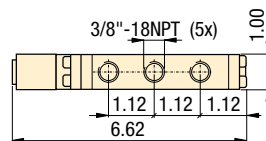
**V-19**



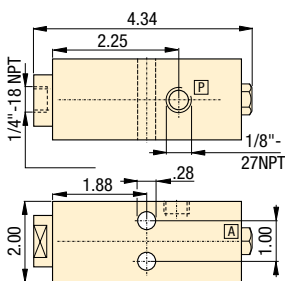
**VAS-42**



**QE-375**

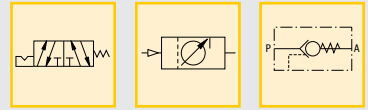


**HV-1000A**



**Air Pressure: 0-150 psi**

- E** Válvulas de aire
- F** Valves à air
- D** Luftventile



## Options

**Gauges and adaptors**

190 ▶



**Hoses**

192 ▶



**Fittings**

194 ▶



## Important

**Valving help**  
See Basic System Set-up and Valve information in our "Yellow Pages".

197 ▶

Shown: WUD-1301B



The Economy pump is best suited to power small to medium size fixtures. Its lightweight and compact design makes it ideal for applications which require easy transport of the pump. The universal motor works well on long extension cords.

## Heavy on performance, light on weight

- Lightweight and compact design, 26 lbs
- Large easy-carry handle for maximum portability
- Two-speed operation reduces cycle times for improved productivity
- 115 VAC 50/60- or 220 VAC 50/60-cycle universal motor will operate on voltage as low as 60 volts
- 24 VDC remote motor control, 10-ft length for operator safety
- Starts under full load
- High strength molded shroud with integral handle, protects motor from contamination and damage
- Designed for intermittent duty cycle

### WUD-1100 series

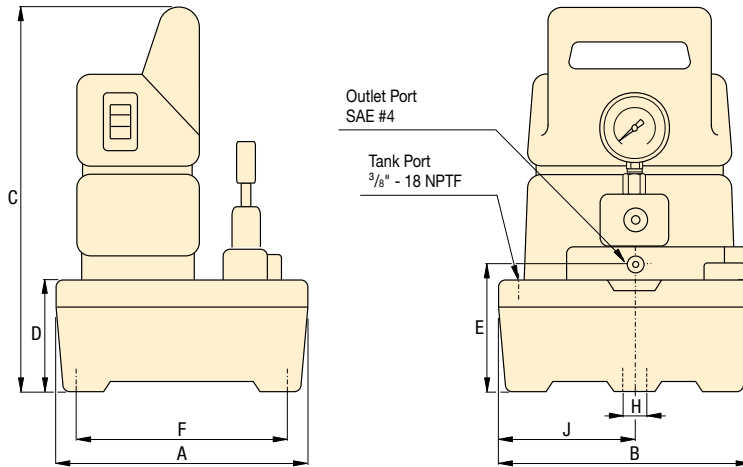
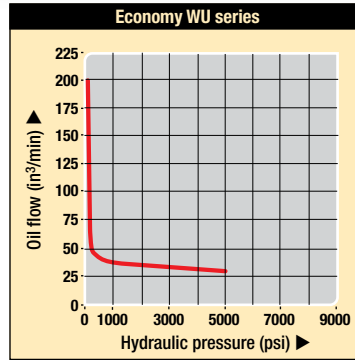
- Provides advance/auto-retract of single-acting cylinders
- 10-foot pendant controls motor and valve operation
- Use with AP500

### WUD-1300 series

- Provides advance/hold/retract of single-acting cylinders
- 10-foot pendant controls motor and valve operation
- Ideal for applications requiring remote valve operation
- Use with ACBS22 or ACBS202

## Product selection

Model number	Used with cylinder	Pressure rating (psi)	
		1st stage	2nd stage
<b>WUD-1100B</b>	single-acting	200	5,000
<b>WUD-1101B</b>	single-acting	200	5,000
<b>WUD-1100E</b>	single-acting	200	5,000
<b>WUD-1101E</b>	single-acting	200	5,000
<b>WUD-1300B</b>	single-acting	200	5,000
<b>WUD-1301B</b>	single-acting	200	5,000
<b>WUD-1300E</b>	single-acting	200	5,000
<b>WUD-1301E</b>	single-acting	200	5,000



- Flow: 25 in<sup>3</sup>/min
- Pressure: 5000 psi max
- Motor: .5 hp
- Reservoir: 0.5-1 gallon

- E** Bombas eléctricas
- F** Centrale hydraulique
- D** Tauchpumpe

## Standard equipment

### Gauge, filter and pressure switch



Pumps are supplied with a manifold mounted 6000 psi gauge for convenient reading of pump pressure.

A filter at the pressure port helps to protect the pump from contamination.

A manifold mounted adjustable pressure switch provides control of the pump shut-off pressure.

## Product dimensions in inches [ ]

Usable oil capacity	Model number	A	B	C	D	E	F	H	J	
gal										lbs
.50	<b>WUD-1100B</b>	9.62	9.62	14.25	4.00	4.72	8.00	.40	5.25	26
1.0	<b>WUD-1101B</b>	14.50	12.18	14.72	4.15	5.12	12.74	.40	5.62	35
.50	<b>WUD-1100E</b>	9.62	9.62	14.25	4.00	4.72	8.00	.40	5.25	26
1.0	<b>WUD-1101E</b>	14.50	12.18	14.72	4.15	5.12	12.74	.40	5.62	35
.50	<b>WUD-1300B</b>	9.62	9.62	14.25	4.00	4.72	8.00	.40	5.25	26
1.0	<b>WUD-1301B</b>	14.50	12.18	14.72	4.15	5.12	12.74	.40	5.62	35
.50	<b>WUD-1300E</b>	9.62	9.62	14.25	4.00	4.72	8.00	.40	5.25	26
1.0	<b>WUD-1301E</b>	14.50	12.18	14.72	4.15	5.12	12.74	.40	5.62	35

	Output flow rate		Valve type	Current draw	Motor voltage	Sound level	Model number
	1st stage	2nd stage					
	200	25	Dump*	9.5	115	85	<b>WUD-1100B</b>
	200	25	Dump*	9.5	115	85	<b>WUD-1101B</b>
	200	25	Dump*	9.5	220	85	<b>WUD-1100E</b>
	200	25	Dump*	9.5	220	85	<b>WUD-1101E</b>
	200	25	Dump and Hold	9.5	115	85	<b>WUD-1300B</b>
	200	25	Dump and Hold	9.5	115	85	<b>WUD-1301B</b>
	200	25	Dump and Hold	9.5	220	85	<b>WUD-1300E</b>
	200	25	Dump and Hold	9.5	220	85	<b>WUD-1301E</b>

\* Electric dump valve for auto-retract of cylinders.

# Electric submerged pumps

Shown: WEM-1401B



## WE series

Enerpac two stage electric submerged pumps are a quiet, economical workholding power source. Submerged in oil the motor stays cooler when used on an intermittent basis.

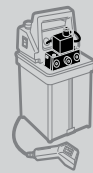
## Best performance for mid-range cylinders

- Reduce cycle times for improved productivity
- Two-speed pump unit provides rapid cylinder advance
- Submerged dual voltage induction motor, runs cooler and quieter (60-70 dBA)
- Available with heat exchanger for higher duty cycle applications
- Externally adjustable relief valve – no need to open pump when reducing pressure
- Reservoir mounting holes for easy mounting to fixed surface
- Full length side tube for easy monitoring of oil level
- Auxiliary return port, eliminates the need for a separate adapter

## Select your pump type

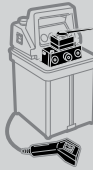
### WED-series with dump valve

- For use when load holding is not required
- Ideal for palletized workholding for single acting circuits
- Motor is on only during work cycle



### WEJ-series with remote jog

- Manual valve control
- Motor can be turned on and off by remote pendant for jogging capability



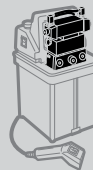
### WEM-series with manual valve

- Manual valve control
- Manual motor control
- Simple and economical solution to your workholding power source needs



### WER-series with remote actuated solenoid

- Solenoid directional with shear seal design
- Remote valve operation



### WES/WET-series with pressure switch

- Pressure switch turns motor on and off
- Used when pressure must be maintained over a period of time
- With pressure gauge



Pressure switch specifications: - Classification NEMA 1  
 - Pressure range: IC-51: 3000-7500 psi  
 IC-31: 500-3500 psi

Flow: 40 in<sup>3</sup>/min

Pressure: 5,000 psi max

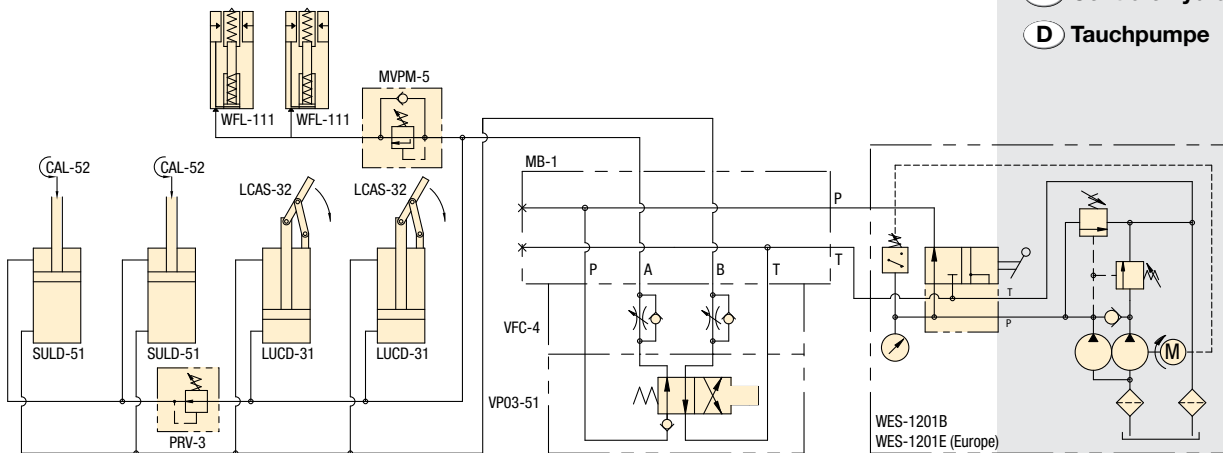
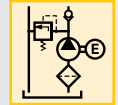
Motor: .5 hp

Reservoir: 1.5 gal

**E** Bombas eléctricas

**F** Centrale hydraulique

**D** Tauchpumpe



	Used with cylinder	Valve function	Valve type	Model number	Motor voltage 50/60 Hz	Heat exchanger
	Single-Acting	Advance / Retract	Dump	<b>WED-1101B</b>	115V	
	Single-Acting	Advance / Retract	Dump	<b>WED-1101E</b>	230V	
	Single-Acting	Advance / Retract	Jog	<b>WEJ-1201B</b>	115V	
	Single-Acting	Adv. / Hold / Retr.	Jog	<b>WEJ-1301B</b>	115V	
	Double-Acting	Adv. / Hold / Retr.	Jog	<b>WEJ-1401B</b>	115V	
	Single-Acting	Advance / Retract	Manual 3/2	<b>WEM-1201B</b>	115V	
	Single-Acting	Advance / Retract	Manual 3/2	<b>WEM-1201D</b>	115V	●
	Single-Acting	Advance / Retract	Manual 3/2	<b>WEM-1201E</b>	230V	
	Single-Acting	Advance / Retract	Manual 3/2	<b>WEM-1201F</b>	230V	●
	Single-Acting	Adv. / Hold / Retr.	Manual 3/3	<b>WEM-1301B</b>	115V	
	Single-Acting	Adv. / Hold / Retr.	Manual 3/3	<b>WEM-1301F</b>	230V	●
	Double-Acting	Adv. / Hold / Retr.	Manual 4/3	<b>WEM-1401D</b>	115V	●
	Double-Acting	Adv. / Hold / Retr.	Manual 4/3	<b>WEM-1401E</b>	230V	
	Single-Acting	Adv. / Hold / Retr.	Solenoid	<b>WER-1301B</b>	115V	
	Single-Acting	Adv. / Hold / Retr.	Solenoid	<b>WER-1301D</b>	115V	●
	Single-Acting	Adv. / Hold / Retr.	Solenoid	<b>WER-1301E</b>	230V	
	Double-Acting	Adv. / Hold / Retr.	Solenoid	<b>WER-1401B</b>	115V	
	Double-Acting	Adv. / Hold / Retr.	Solenoid	<b>WER-1401D</b>	115V	●
	Double-Acting	Adv. / Hold / Retr.	Solenoid	<b>WER-1401F</b>	230V	●
	Single-Acting	Advance / Retract	Manual 3/2	<b>WES-1201B</b>	115V	
	Single-Acting	Advance / Retract	Manual 3/2	<b>WET-1201B</b>	115V	
	Single-Acting	Adv. / Hold / Retr.	Manual 3/3	<b>WES-1301B</b>	115V	
	Single-Acting	Adv. / Hold / Retr.	Manual 3/3	<b>WES-1301E</b>	230V	
	Double-Acting	Adv. / Hold / Retr.	Manual 4/3	<b>WES-1401B</b>	115V	
	Double-Acting	Adv. / Hold / Retr.	Manual 4/3	<b>WES-1401E</b>	230V	

## Options

**G-series pressure gauges**

☐ 190 ▶



**FL-series high-pressure filters**

☐ 193 ▶



**FZ-series fittings**

☐ 194 ▶



**HF-series hydraulic oil**

☐ 193 ▶



## ! Important

Oil should be replaced every 500 working hours to ensure long life. Change filters when changing oil or 4 times a year whichever comes first.

Heat exchanger cools oil in pumps used in higher duty cycle applications.

Output flow rate should be matched to hydraulic components used in the system.

# WE-Series, Submerged Electric Pumps

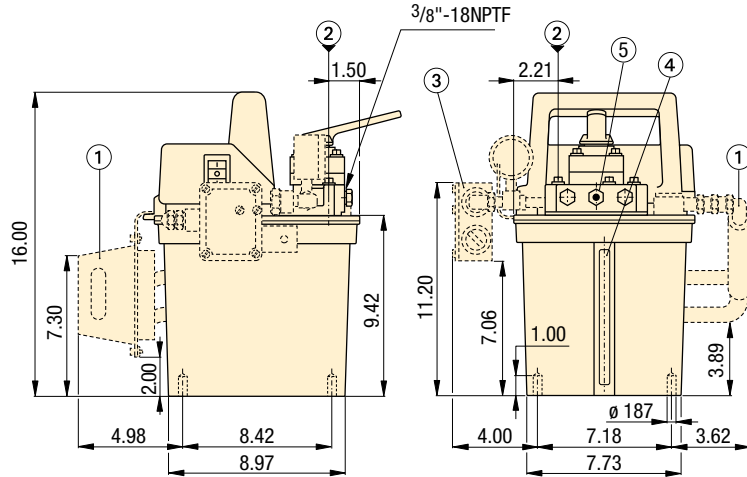
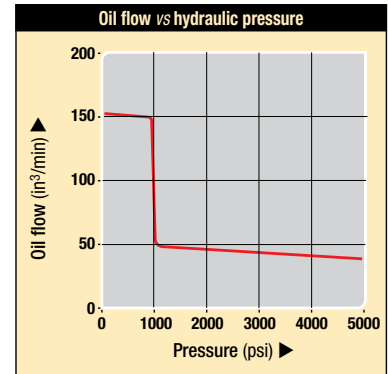
Shown: WEM-1401B



## WER series

Enerpac submerged motor pumps are available in a wide range of configurations to fit any requirement.

◀ For full features see page 110.



Dimensions shown in inches.

- ① Heat Exchanger (optional for all models)
- ② Fill Port
- ③ Pressure Switch (WES-Series, optional for other models)
- ④ Oil Level Indicator
- ⑤ Adjustable Relief Valve

## Product selection

Motor voltage	Motor capacity	Amperage draw	Maximum oil flow**		Pressure rating		Usable oil capacity	Adjustable relief valve	Weight
			1st stage	2nd stage	1st stage	2nd stage			
50/60 Hz 1 ph	hp	amps	1st stage	2nd stage	1st stage	2nd stage	gal	psi	lbs
115V-1ph	.50	13.5	150	40	1000	5000	1.5	1000 - 5000	63 <sup>1)</sup>
230V-1ph	.50	6.75	150	40	1000	5000	1.5	1000 - 5000	63 <sup>1)</sup>

<sup>1)</sup> Weight for WES and WET models is 83 lbs.

\*\* All flow data at 60 Hz, 50 Hz data will be 5/6 th this number.

Collet-Lok® product line  
Swing clamps  
Work supports  
99\_088  
Linear clamps  
Power sources



 Custom build your submerged pump

▼ This is how a submerged pump model number is built up:

If the submerged pump that would best fit your application cannot be found in the chart on page 111, you can easily build your custom submerged pump here.



**1 Product Type**

**W** = Workholding Pump

**2 Motor Type**

**E** = Electric motor

**3 Pump Type**

**D** = Dump

**J** = Jog

**M** = Manual

**R** = Remote (solenoid)

**S** = Pressure switch (IC-51)

**T** = Pressure switch (IC-31)

**4 Pump Series**

**1** = .5 hp 10,000 psi

**5 Valve Type**

**0** = No valve (WER only)

**1** = Dump

**2** = 3-way, 2-position, normally open

**3** = 3-way, 3-position, tandem center

**4** = 4-way, 3-position, tandem center

**5** = Custom VE-series valve (WER only)

See example 2 below.

**6 Reservoir Capacity**

**01** = 1.5 gallon

**7 Motor Voltage and Heat Exchanger**

**B** = 115 V, 1 Ph, 50/60 Hz

**D** = 115 V, 1 Ph, 50/60 Hz with heat exchanger

**E** = 230 V, 1 Ph, 50/60 Hz

**F** = 230 V, 1 Ph, 50/60 Hz with heat exchanger

**I** = 230 V, 1 Ph, 60 Hz\*

\* To order WER models, for 60 Hz applications, replace the "E" suffix for "I".

Ordering example 1



Examples

**Model number:**

**WER-1301B**

The **WER-1301B** is a .5 hp, 5,000 psi, submerged electric pump, with 1.5 gallon usable oil capacity, a 3-way, 3-position modular, remote solenoid valve (VEF-series) and a 115 V, 1 Phase, 50/60 Hz motor.

**Model number:**

**WER-1501B- VED15000D**

The **WER-1501B** is a .5 hp, 5,000 psi, submerged electric pump, with 1.5 gallon usable oil capacity. The valve, model **VED15000D** is a 115 V, 60 Hz solenoid valve. (For details and options for all VE-series valves see pages 146-147.)

Flow: 40 in<sup>3</sup>/min

Pressure: 5,000 psi max

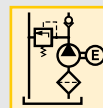
Motor: .5 hp

Reservoir: 1.5 gal

**E** Bombas eléctricas

**F** Centrale hydraulique

**D** Tauchpumpe



 Important

**WER series pumps use the VE-series valves shown on page 146. WER-13 series uses VEF-series valve. WER-14 series uses VEC-series valve.**

**WES series pumps use IC-51 pressure switch, adjustable from 3000-7500 psi.**

**WET series pumps use IC-31 pressure switch, adjustable from 500-3500 psi.**

Shown: ZW5020HB-FT21



## The standard for workholding applications

- Features Z-Class high-efficiency pump design; higher oil flow and by-pass pressure, cooler running and requires 18% less current than comparable pumps
- Totally enclosed, fan cooled industrial electric motors supply extended life and stand up to harsh industrial environments
- Multiple valve and reservoir configurations provide application specific models to match the most demanding workholding applications
- High-strength, molded electrical enclosure protects electronics, power supplies and LCD readout from coolant and contamination

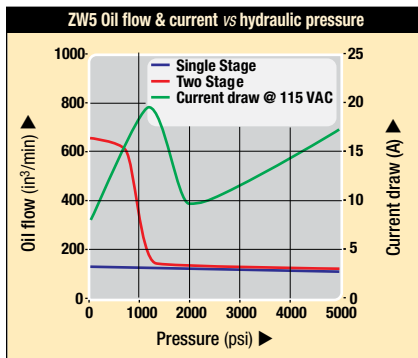
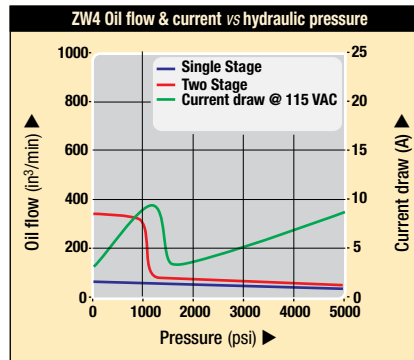
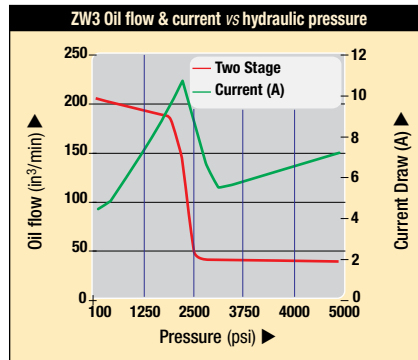
**Z-Class electric pumps are designed for use in the harshest manufacturing environments. The pumps provide reliable and durable performance in a wide variety of configurations.**

### Basic configurations

All pumps listed in this chart include LCD electrical box, 5 gallon reservoir, return line filter and either 0-6000 psi pressure gauge or pressure transducer (solenoid valve models). For additional options, see the complete pump matrix on page 117.

	Pump type	Valve/manifold type	Motor voltage
			50/60 Hz
<b>ZW-Series with manifold</b> <ul style="list-style-type: none"> <li>• Used when supplying pressure to multiple valve circuits</li> <li>• Valves must be supplied separately</li> </ul>		Pressure and tank ports	230 VAC, 3 ph
		Single station DO3	230 VAC, 3 ph
		Enerpac VP-series	230 VAC, 3 ph
		Two station DO3	230 VAC, 3 ph
		Four station DO3	230 VAC, 3 ph
<b>ZW-Series with pallet coupling valve</b> <ul style="list-style-type: none"> <li>• Provides momentary pressure and flow to fixture</li> <li>• Ideal for pallet disconnect systems</li> </ul>		4-way, 3-pos. solenoid operated	115 VAC, 1 ph
		4-way, 3-pos. solenoid operated	230 VAC, 3 ph
		4-way, 3-pos. solenoid operated	460 VAC, 3 ph
<b>ZW-Series with continuous connection valve</b> <ul style="list-style-type: none"> <li>• Provides solenoid control of one single or double-acting circuit</li> <li>• Control valve supplied with integrated pilot operated check to ensure positive pressure holding</li> </ul>		4-way, 3-pos. solenoid operated	115 VAC, 1 ph
		4-way, 3-pos. solenoid operated	230 VAC, 3 ph
		4-way, 3-pos. solenoid operated	460 VAC, 3 ph
<b>ZW-Series with manual valve</b> <ul style="list-style-type: none"> <li>• Provides manual control of one single or double-acting circuit</li> <li>• Control valve supplied with center holding function to ensure positive position holding</li> </ul>		4-way, 3-pos. manually operated	115 VAC, 1 ph
		4-way, 3-pos. manually operated	230 VAC, 3 ph
		4-way, 3-pos. manually operated	460 VAC, 3 ph

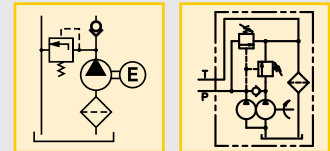
## Output oil flow and current draw



ZW3 Series Output oil flow at 5000 psi 40 in³/min	ZW4 Series Output oil flow at 5000 psi 60 in³/min	ZW5 Series Output oil flow at 5000 psi 120 in³/min
LCD Electric Model Number	LCD Electric Model Number	LCD Electric Model Number
ZW3020HG-FG01	ZW4020HG-FG01	ZW5020HG-FG01
ZW3020HG-FG11	ZW4020HG-FG11	ZW5020HG-FG11
ZW3020HG-FG12	ZW4020HG-FG12	ZW5020HG-FG12
ZW3020HG-FG21	ZW4020HG-FG21	ZW5020HG-FG21
ZW3020HG-FG41	ZW4020HG-FG41	ZW5020HG-FG41
ZW3420DB-FT	ZW4420DB-FT	ZW5420DB-FT
ZW3420DG-FT	ZW4420DG-FT	ZW5420DG-FT
ZW3420DJ-FT	ZW4420DJ-FT	ZW5420DJ-FT
ZW3420FB-FT	ZW4420FB-FT	ZW5420FB-FT
ZW3420FG-FT	ZW4420FG-FT	ZW5420FG-FT
ZW3420FJ-FT	ZW4420FJ-FT	ZW5420FJ-FT
ZW3420LB-FG	ZW4420LB-FG	ZW5420LB-FG
ZW3420LG-FG	ZW4420LG-FG	ZW5420LG-FG
ZW3420LJ-FG	ZW4420LJ-FG	ZW5420LJ-FG

- Flow rate: 40-120 in³/min
- Pressure: 5000 psi max
- Motor: 1.0 & 1.5 hp
- Reservoir: 2-10 gal

- E** Bombas eléctricas
- F** Centrale hydraulique
- D** Tauchpumpe



### Important

All Z-Class electric pumps are CSA and CE compliant.



LCD electrical package is required for pumps utilizing electric valves, or optional accessories such as the pressure transducer, level switch, pressure switch or heat exchanger.

Single-stage pumps provide constant flow throughout the entire pressure range via a radial piston pump. Two-stage pumps provide high flow via a gear pump until the bypass pressure is reached. At pressures above the bypass setting, the radial piston pump provides flow to the maximum pressure.

Shown: ZW5020HB-FT21



## ZPF series

The oil filter kit removes contaminants from the return oil flow before allowing it back into the reservoir, reducing component damage.

- Efficient design reduces heat generation and reduces power consumption
- Balanced pump section reduces vibration improving durability and sound levels
- Optional back-lit LCD readout provides hour and cycle counts, low voltage warnings and pressure read-out when used with pressure transducer
- Low-voltage pendant on solenoid valve models with sealed switches improves operator safety
- **Z-Class** electric pumps can be supplied with factory installed accessories such as valve manifold, pressure transducer, and return line filter, creating a complete power unit solution

<b>Flow:</b> 40-120 in <sup>3</sup> /min
<b>Pressure:</b> 5000 psi
<b>Motor:</b> 1.0 & 1.5 hp
<b>Reservoir:</b> 2-10 gallon

- (E) Bombas eléctricas
- (F) Centrale hydraulique
- (D) Tauchpumpe

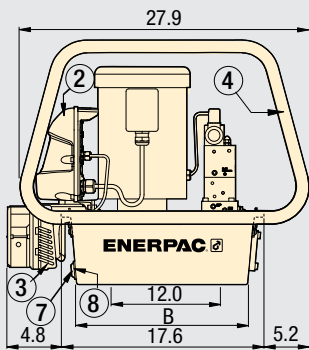
## Options

### User adjustable relief valve

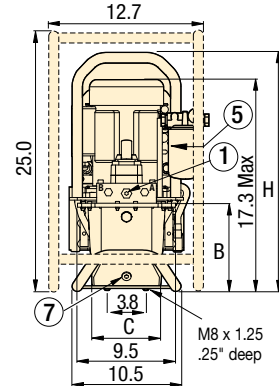
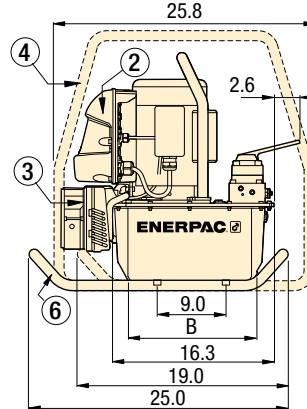
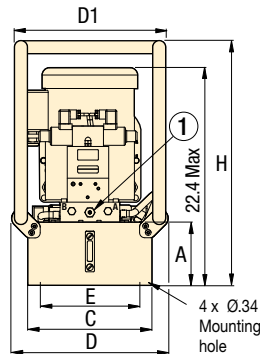


All ZW-Series have a user adjustable relief valve to allow the operator to easily set the optimum working pressure.

2.5, 5, 10 gallon



2 gallon



- ① Pump mounted manifold
  - User adjustable relief valve
  - 3/8" NPTF on A and B ports
  - 1/4" NPTF on auxiliary ports
- ② Electric Box (Optional w/manual valve)
- ③ Heat Exchanger (Optional)
- ④ Roll Bar (Optional)
- ⑤ Return Line Filter (Optional)
- ⑥ Skid Bar (Optional)
- ⑦ Oil Drain
- ⑧ Oil Level/Temperature Switch (Optional)

## Product dimensions in inches [ ]

Usable oil capacity	ZW Series pump dimensions (in)						
	A	B	C	D	D1	E	H
2.0	8.1	11.3	6.6	-	-	-	22.6
2.5	6.1	16.5	12.0	15.1	14.6	11.0	23.6
5.0	7.1	16.5	16.6	19.7	19.2	15.6	24.6
10.0	10.6	15.7	19.9	22.7	22.5	18.9	28.1

## Product selection

Output flow rate in <sup>3</sup> /min					Pump series	Motor size hp	Relief Valve adjustment range psi	Sound level dBA
100 psi	700 psi	1700 psi	3000 psi	5000 psi				
203	196	170	40	<b>40</b>	ZW3*	1.0	1,000-5,000	75
350	305	-	63	<b>60</b>	ZW4	1.0	1,000-5,000	75
650	602	-	123	<b>120</b>	ZW5	1.5	1,000-5,000	75

\* Constant flow rate for single-stage models.

Collet-Lok® product line  
Swing clamps  
Work supports  
Linear clamps  
Power sources

## Custom build your pump

▼ This is how a ZW series Model number is built:

<b>Z</b>	<b>W</b>	<b>4</b>	<b>0</b>	<b>20</b>	<b>H</b>	<b>G</b>	<b>-FG</b>	<b>01</b>
1	2	3	4	5	6	7	8	9
Product Type	Motor Type	Flow Group	Valve Type	Usable Oil Capacity	Valve Operation	Voltage	Options	Manifold Options

### 1 Product type

**Z** = Z-Class Pump

### 2 Motor type

**W** = Workholding Electric

### 3 Flow group

**3** = 40 in<sup>3</sup>/min

**4** = 60 in<sup>3</sup>/min

**5** = 120 in<sup>3</sup>/min

### 4 Valve type

**0** = No valve or valve manifold

**2** = 3-way, 2-position, manual valve

**3** = 3-way, 3-position, manual valve

**4** = 4-way, 3-position, manual or solenoid valve

**6** = 3-way, 3-position, tandem center w/P.O. check (manual only)

**8** = 4-way, 3-position, tandem center w/P.O. check (manual only)

### 5 Usable oil capacity

**8** = 8 Liters (2 gallon)

**10** = 10 Liters (2.5 gallon)

**20** = 20 Liters (5 gallon)

**40** = 40 Liters (10 gallon)

### 6 Valve operation

**D** = Solenoid valve (pallet coupling) with pendant and LCD (valve type **4**)

**F** = Solenoid valve (continuous connection) with pendant and LCD (valve type **4**)

**G** = Valve manifold without LCD (valve type **0**)

**H** = Valve manifold with LCD (valve type **0**)

**L** = Manual valve with LCD (without pendant, valve type **2, 3, 4, 6** or **8**)

**M** = Manual valve without LCD (valve type **2, 3, 4, 6** or **8**)

**N** = No valve, without LCD (valve type **0**)

**W** = No valve with LCD (valve type **0**)

### 7 Power supply

Single Phase

**B** = 115V, 1 ph, 50-60 Hz<sup>3</sup>

**E** = 208-240V, 1 ph, 50-60 Hz  
European plug

**I** = 208-240V, 1 ph, 50-60 Hz  
USA plug

Three Phase

**M** = 190-200V, 3 ph, 50/60 Hz

**G** = 208-240V, 3 ph, 50/60 Hz

**W** = 380-415V, 3 ph, 50/60 Hz

**K** = 440V, 3 ph, 50/60 Hz

**J** = 460-480V, 3 ph, 50/60 Hz

**R** = 575V, 3 ph, 50/60 Hz

### 8 Options<sup>2</sup>

**F** = Return line filter, 25 micron

**G** = 0-6000 psi pressure gauge, 21/2"<sup>5</sup>

**H** = Heat exchanger<sup>4</sup>

**L** = Level/temperature switch<sup>4</sup>

**N** = No handles (lifting eyes only)<sup>2</sup>

**P** = Pressure switch<sup>4</sup>

**R** = Roll bars

**S** = Single stage

**T** = Pressure transducer<sup>4</sup>

**U** = Foot switch<sup>4</sup>

### 9 Manifold options<sup>5</sup> (Pump types G and H only)

**01** = Pressure & tank porting manifold

**11** = Single station D03

**12** = VP series manifold

**13** = Single station CETOP

**21** = 2 station D03

**22** = 2 station CETOP

**41** = 4 station D03

**42** = 4 station CETOP

<sup>1</sup> Options should be specified in alphabetical order.

<sup>2</sup> Unless specified, all pumps are supplied with reservoir handles.

<sup>3</sup> 115 volt pumps are supplied with CE and CSA approved 15 amp plug for intermittent use. 20 A circuit recommended for frequent full pressure use.

<sup>4</sup> These options require LCD electrical package.

<sup>5</sup> Pressure gauge not available on pump models with pressure transducer. Pressure transducer provides digital pressure readout on LCD display.

<sup>6</sup> Pressure switch option is only used as input to a customer control. It is not used with the LCD electrical package.

Flow: 40-120 in<sup>3</sup>/min

Pressure: 5000 psi max

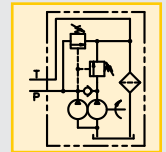
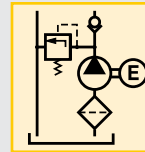
Motor: 1.0 & 1.5 hp

Reservoir: 2.0-10 gal.

**E** Bombas eléctricas

**F** Centrale hydraulique

**D** Modulare Spannumpme



## Example

**ZW4020GB-FGS21** is a 60 in<sup>3</sup>/min, single-stage pump with a 2 station D03 manifold, standard electric without LCD, 5 gallon reservoir, 115 volt, 50/60 Hz motor, return line filter and 0-6000 psi pressure gauge.

**ZW4410DJ-T** is a 60 in<sup>3</sup>/min, 2-stage pump with a pallet de-coupling valve, LCD electrical box, 2.5 gallon reservoir, 460-480 volt 3-phase motor and pressure transducer.

**ZW5040HJ-FGL01** is a 120 in<sup>3</sup>/min, 2-stage pump with a pressure and tank manifold, LCD electrical box, 10 gallon reservoir, 460-480 volt 3-phase motor, return line filter, 0-6000 psi pressure gauge and level and temperature shutdown switch.

## Example

The **ZW5810LG-FT** is a 120 in<sup>3</sup>/min, 2-stage pump with a manual 4-way, 3 position tandem center valve, integrated P.O. check, LCD electrical box, 2.5 gallon reservoir, 208-240 volt 3-phase motor, return line filter and pressure transducer.

Shown: ZPF



### ZPF series

The oil filter kit removes contaminants from the return oil flow before allowing it back into the reservoir, reducing component damage.

## Extend life of hydraulic components

...increase system reliability

- 25 micron nominal filter cleans oil to increase system life
- Internal bypass valve to prevent damage if the filter is dirty
- All installation components included
- Kit assembles quickly and easily to Enerpac pump and manifold
- Maintenance indicator included

Filtration: 25 micron

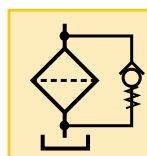
Pressure: max. 200 psi

Max. flow: 12.0 GPM

**E** Filtro

**F** Filtre

**D** Filter

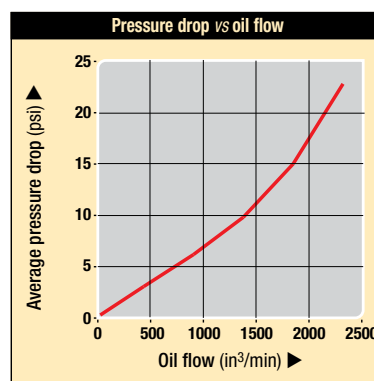


### Options


PF-25 replacement filter element



For best performance, replace filter element on a regular basis. Change filters when changing oil or four times a year, whichever comes first.



### Product selection

Nominal filtration	Model number	Maximum pressure	Maximum oil flow	Bypass pressure setting	Filter gauge service indicator	
micron		psi	gpm	psi		lbs
25	ZPF	200	12.0	25	✓	3.2

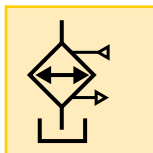
Collet-Lok® product line  
Swing clamps  
Work supports  
Linear clamps  
Power sources

**Transfer: 900 Btu/h**

**Pressure: max. 300 psi**

**Voltage: 24V**

- E** Intercambiador de calor
- F** Échangeur de chaleur
- D** Wärmetauscher



## Extends system life

- Electrical connector factory installed
- All installation components included
- Stabilizes oil temperature at a maximum of 130° F at 70° F ambient temperature
- Stabilizes oil viscosity, increasing oil life and reduces wear of pump and other hydraulic components

Shown: ZHE-E10



### ZHE series

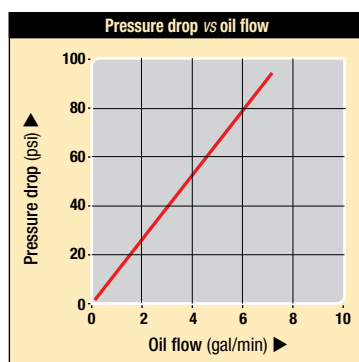
Heat exchanger removes heat from the return oil to provide cooler operation.

### Important

#### ZHE- Series Heat Exchangers

Heat exchanger stabilizes oil temperature at 130° F at 70° F ambient temperature. Thermal transfer at 5 GPM and 70° F ambient temperature: 900 Btu/hour.

**Do not exceed maximum oil flow of 7.0 GPM and maximum pressure of 300 psi. Not suitable for water-glycol or high water based fluids.**



## Product selection

Voltage	Model number	Thermal transfer*		Amperage draw	Maximum pressure	Maximum oil flow	
		Btu/h	kJoule				
24 VDC	<b>ZHE-E10</b>	900	950	.95	300	7.0	9.0

\*At 0.5 g/min and ambient temperature of 70° F.

Collet-Lok® product line  
Swing clamps  
Work supports  
Linear clamps  
Power sources

Shown: ZLS-U4



## ZLS series

Oil level indicator for pump reservoir. If the pump is mounted in a remote area that does not provide visual access to the external oil level sight glass, the level/temp switch will turn off the pump before internal damage can occur due to cavitations.

## Electronic level/temp switch for feedback on pump oil level

- Drop-in design allows for easy installation to pump reservoir
- Electrical connector included
- Built-in thermal sensing provides feedback on oil temperature
- Senses low oil level in pump reservoir

Temp. set point: 175 °F

Voltage: 24 VDC

- (E) Indicador del nivel/temp.
- (F) Interrupteur de niveau/temp.
- (D) Ölstand/Temperaturschalter



## Product Selection

Fixed temperature signal	Model number	Voltage	Thermostat rating setting	Maximum pressure	
°F			Amps	psi	lbs
175	ZLS-U4	24 VDC	2.6	150	0.11

Shown: ZPT-U4, ZPS-W4



## ZPT/ZPS series

ZPT pressure transducer provides constant pressure monitoring for automated pump control. ZPS can be used to provide a pressure signal to an external control.

## Control your pump, monitor pressure

### ZPT pressure transducer

- More durable than analog gauges (against mechanical and hydraulic shock)
- More accurate than analog gauges (0.5% full scale)
- Calibration can be fine tuned for certification
- “Auto-mode” provides automatic pressure make-up
- Display pressure in psi, bar or MPa

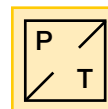
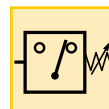
### ZPS-E3 pressure switch

- Includes glycerin filled gauge, G2536L
- Can be used to provide pressure input to customer provided controls
- Not to be used with LCD control
- For pressure based input to the LCD control, use the ZPT-U4 transducer

Pressure: 50-10,000 psi

Voltage: 115 VAC / 24 VDC

- (E) Presión transductor
- (F) Pressostats
- (D) Druckschalter



## Product Selection

Adjustable pressure range	Electrical specification	Model number	Accuracy (full scale)	Deadband	
psi				psi	lbs
50-10,000	4-20 mA	ZPT-U4	0.5%	50	0.3
500-10,000	115 VAC/ 24 VDC N.O.	ZPS-W4	2%	115-550	2.7

▼ Mechanical adjustment

Note: Electrical harness included with kit. ZPS-W4 includes 0-6000 psi pressure gauge.

## Important

The pressure transducer is factory installed in the “A” port on pumps supplied with valves, and in the “P” port on models with manifolds.

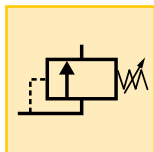


**Pressure: 5000 psi**

**Stations: 1-4 valves horizontal**

**Stations: 1-8 valves vertical**

- E** Colectores
- F** Manifolds
- D** Verkettungsblöcke



## Increased flexibility for complex systems

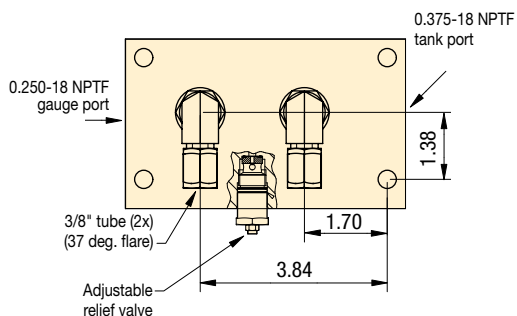
- Manifolds provide hydraulic connection to remote or pump mounted valves
- Used when multiple valves are required for controlling several independent circuits
- Available for 2 and 4 station DO3 as well as Enerpac VP series mounting
- Pressure and tank porting manifold available for use with remote valve sticks
- Manifolds include integrated relief valve for system pressure control

Shown: MB-2, -4

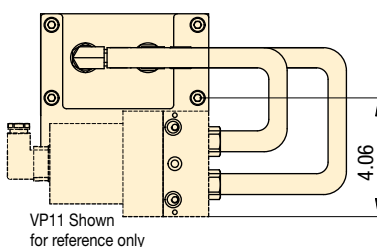


Manifolds allow the use of multiple valves powered by a single hydraulic pump. Manifolds are available factory installed on your Z-Class workholding power unit, or separately for future system upgrades.

### Option 01



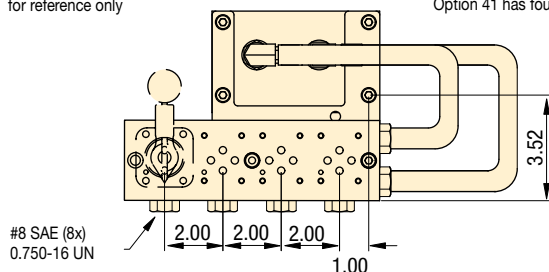
### Option 12



### Option 21, 41

VMMD-001 Shown for reference only

Option 21 has two valve stations  
Option 41 has four valve stations



## Product Selection

Valve mounting pattern	Option code (see page 117)	Number of stations	Coverplate model number
Porting manifold, SAE ports	01	-	-
Enerpac VP Series	12	1-8	-
2 station DO3	21	2	MC-1
4 station DO3	41	4	MC-1
2 station CETOP3	22	2	MC-3
4 station CETOP3	42	4	MC-3

## Options

**Pressure transducer**

120 ▶



**Level switch**

120 ▶



■ Enerpac porting manifold provides pressure and tank line to remote mounted valve stack on a machining center.



Shown: ZW4420DB-FT



**The new Enerpac Pallet Coupling Pump provides three modes of operation:**

### Manual mode

Pump runs as long as operator holds down pendant button.

### AUTO mode *without timer*

Pump runs until user-adjustable pressure setting is reached.

### AUTO mode *with timer*

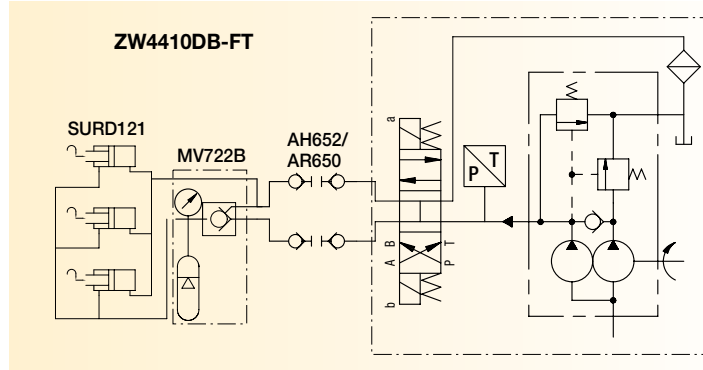
Pump runs until pressure setting is reached, and adjustable timer runs out.

## Automatic pressure control for palletized fixtures

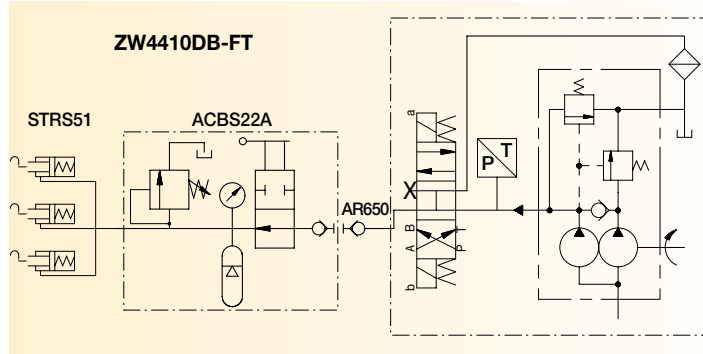
- Programmable clamp and unclamp pressure settings increase automation capability
- Programmable dwell settings ensure desired pressure level is maintained on large circuits or circuits with accumulators
- Low-voltage pendant features sealed switches and operates at 15 VDC for improved operator safety
- Backlit LCD provides pump usage information, hour and cycle counts

## Example Circuits

- Double-acting circuit



- Single-acting circuit



■ **ZW5410DB-FT** used to connect and disconnect a palletized fixture.



## Product selection

Output flow rate @ max. pressure	Motor size	Motor voltage	Model number	Pressure range	Sound level	Usable oil capacity	
in <sup>3</sup> /min	hp			psi	dBA	gal	lbs
40	1.0	115-1-60	<b>ZW3408DB-FT</b>	1000-5000	75	2	115
		115-1-60	<b>ZW3410DB-FT</b>		75	2.5	134
		230-1-60	<b>ZW3408DI-FT</b>		75	2	115
		230-1-60	<b>ZW3410DI-FT</b>		75	2.5	134
60	1.0	115-1-60	<b>ZW4410DB-FT</b>	1000-5000	75	2.5	120
		230-3-60	<b>ZW4410DG-FT</b>				
		460-3-60	<b>ZW4410DJ-FT</b>				
120	1.5	115-1-60	<b>ZW5410DB-FT</b>	1000-5000	75	2.5	130
		230-3-60	<b>ZW5410DG-FT</b>				
		460-3-60	<b>ZW5410DJ-FT</b>				

Collet-Lok® product line  
Swing clamps  
Work supports  
Linear clamps  
Power sources

## **i** Operation – pallet coupling pump

### Manual mode

Motor and pump operate only when operator presses and holds the up (or down) arrow on the pendant. When button is released, pressure in the hoses is relieved.

### AUTO mode

With DWELL timer set equal to zero, operator starts the motor by pressing and holding the up (or down) arrow on the pendant. Pump builds to pressure on the clamp (or unclamp) circuit until it reaches customer programmed setting. The motor immediately turns off and pressure in the hoses is relieved.

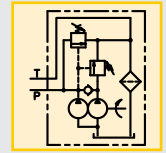
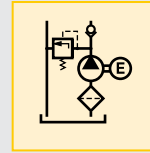
With DWELL timer set greater than zero, operator starts the motor by pressing the up (or down) arrow on the pendant. Once the pump reaches the programmed setting, the DWELL timer starts. When the timer runs out, the motor stops and pressure in the hoses is relieved.

Flow: 40-120 in<sup>3</sup>/min

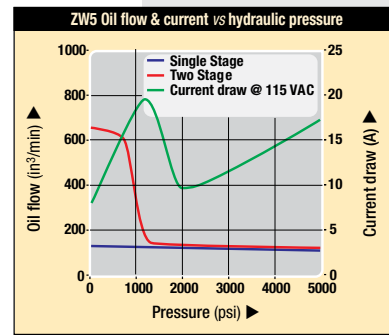
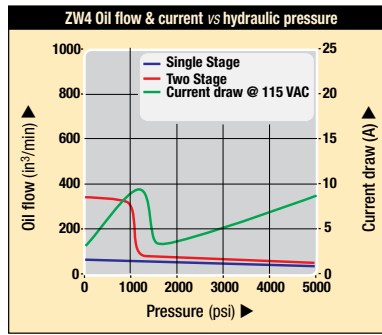
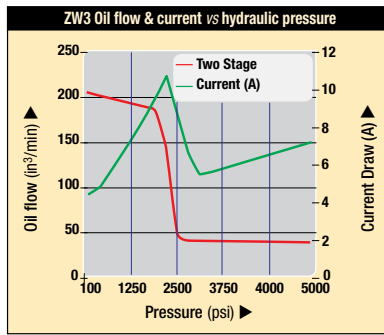
Pressure: 5000 psi max

Motor: 1.0 or 1.5 hp

Reservoir: 2.0-10.0 gal

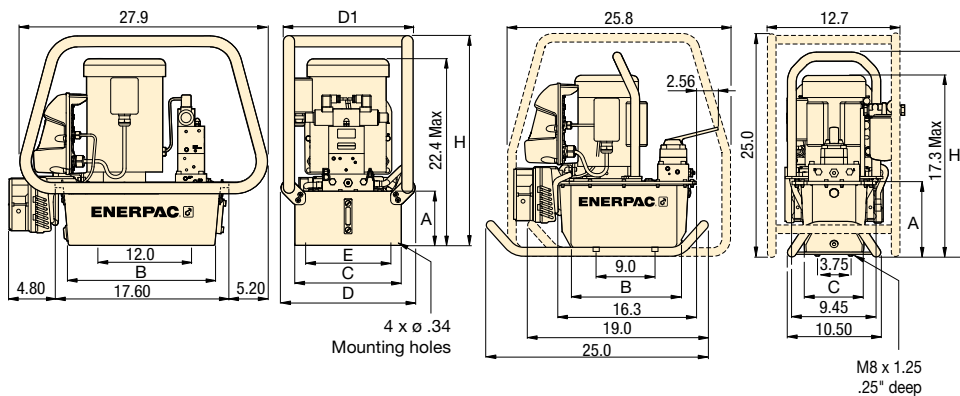


## **i** Output oil flow and current draw



2.5, 5, 10 gallon

2 gallon



## **!** Important

Enerpac recommends a pressure differential of no less than 200 psi for most applications. If you believe your application requires a tighter differential, please contact us directly.

For complete ordering matrix of all factory-installed options see page 117.

## **A** Product dimensions in inches [ ]

Usable oil capacity	Modelo number	A	B	C	D	D1	E	H	lbs		
									ZW3	ZW4	ZW5
gal											
2.0	ZWxx08xx	8.1	11.0	8.1	—	—	—	22.6	93	93	103
2.5	ZWxx10xx	6.1	16.5	12.0	15.1	14.6	11.0	23.6	107	107	115
5.0	ZWxx20xx	7.1	16.5	16.6	19.7	19.2	15.6	24.6	134	134	142
10.0	ZWxx40xx	10.6	15.7	19.9	22.7	22.5	18.9	28.1	184	184	192

## **i** Options

Heat exchanger

119 ▶



Level switch

120 ▶



Pressure transducer

120 ▶



Return line filter

118 ▶



# Continuous connection pumps *Application & selection*

Shown: ZW4420FB-FT



**The new Enerpac Continuous Connection Pump provides two modes of operation:**

### Manual mode

Pump runs continuously, building pressure as long as operator holds down pendant button.

### AUTO mode

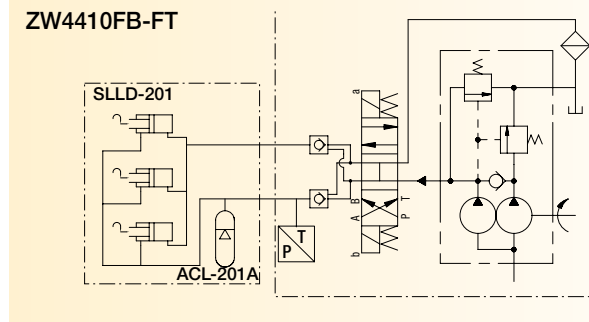
Pump runs continuously, maintaining user-set pressure window on clamp circuit as long as necessary.

## Automatic pressure control for continuous connection fixtures

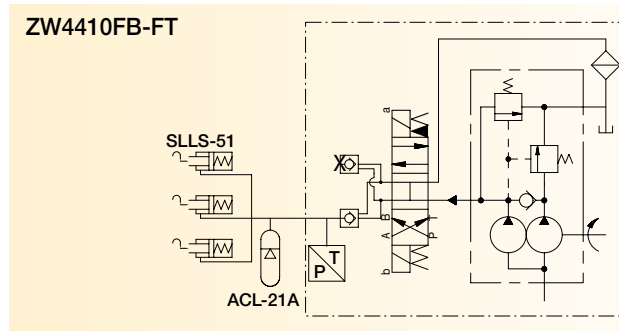
- Programmable pressure setting allows pump to maintain system pressure continuously
- Includes pilot operated check valve ensuring pressure is maintained in circuit
- Z-Class high-efficiency pump design; featuring higher oil flow and by-pass pressure than comparable pumps
- High-strength, molded electrical enclosure protects electronics, power supplies and LCD readout from harsh industrial environments

## Example Circuits

- Double-acting circuit



- Single-acting circuit



■ **ZW5410FB-FT** used to control clamping cycle on a horizontal machining center.



## Product selection

Output flow rate @ max. pressure	Motor size	Motor voltage	Model number	Pressure range	Sound level	Usable oil capacity	
in <sup>3</sup> /min	hp			psi	dBA	gal	lbs
40	1.0	115-1-60	<b>ZW3408FB-FT</b>	1000-5000	75	2	115
		115-1-60	<b>ZW3410FB-FT</b>		75	2.5	134
		230-1-60	<b>ZW3408FI-FT</b>		75	2	115
		230-1-60	<b>ZW3410FI-FT</b>		75	2.5	134
60	1.0	115-1-60	<b>ZW4410FB-FT</b>	1000-5000	75	2.5	120
		230-3-60	<b>ZW4410FG-FT</b>				
		460-3-60	<b>ZW4410FJ-FT</b>				
120	1.5	115-1-60	<b>ZW5410FB-FT</b>	1000-5000	75	2.5	130
		230-3-60	<b>ZW5410FG-FT</b>				
		460-3-60	<b>ZW5410FJ-FT</b>				

Collet-Lok® product line  
Swing clamps  
Work supports  
Linear clamps  
Power sources

## **i** Operation – continuous connection pump

### Manual mode

The operator turns the pump motor on, and then presses and holds the up arrow on the pendant. When the button is released, the valve shifts to neutral, but pressure is maintained in the clamp circuit by the pilot-operated check valve. When the operator presses and holds the down arrow on the pendant, pressure in the clamp circuit will release, and the fixture will unclamp.

### AUTO mode

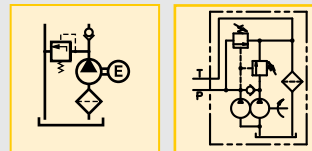
The operator turns the pump motor on, and then presses and holds the up arrow on the pendant. When the customer-programmed HI PRESS setting is reached, the valve shifts to neutral, but pressure is maintained in the clamp circuit by the pilot-operated check valve. If pressure drops below the LO PRESS setting, the valve will re-activate and build pressure in the clamp circuit again. The pump will maintain this cycle until the operator presses and holds the down arrow on the pendant. When the down arrow is pressed, pressure in the clamp circuit will release, and the fixture will unclamp.

Flow: 40-120 in<sup>3</sup>/min

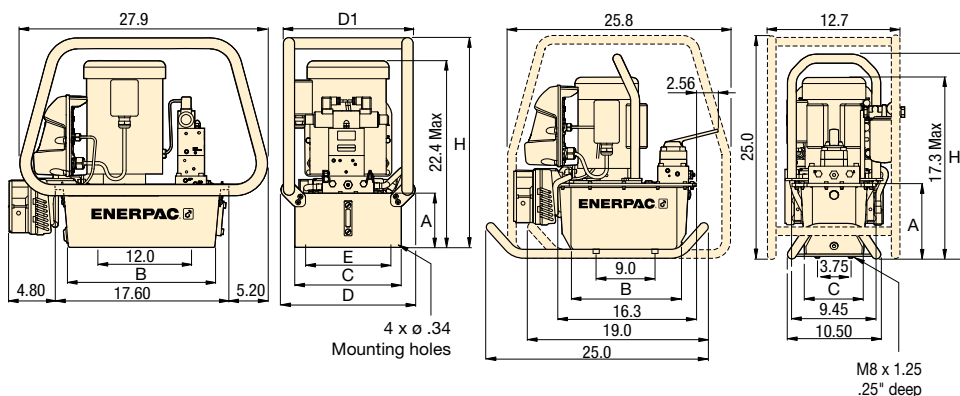
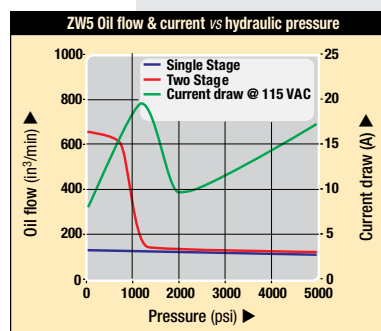
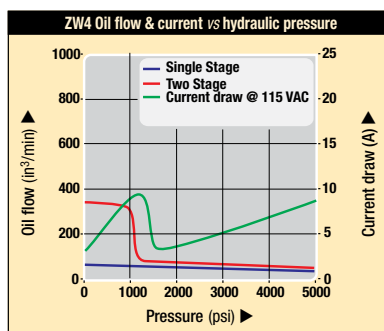
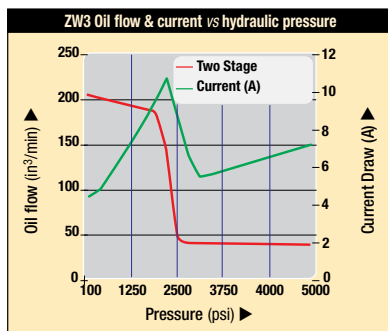
Pressure: 5000 psi max

Motor: 1.0 or 1.5 hp

Reservoir: 2.0-10.0 gal



## **i** Output oil flow and current draw



## **!** Important

Enerpac recommends a pressure differential of no less than 200 psi for most applications. If you believe your application requires a tighter differential, please contact us directly.

For complete ordering matrix of all factory-installed options see page 117.

## **A** Product dimensions in inches [ ]

Usable oil capacity	Modelo number	A	B	C	D	D1	E	H	lbs		
									ZW3	ZW4	ZW5
gal											
2.0	ZWxx08xx	8.1	11.0	8.1	—	—	—	22.6	93	93	103
2.5	ZWxx10xx	6.1	16.5	12.0	15.1	14.6	11.0	23.6	107	107	115
5.0	ZWxx20xx	7.1	16.5	16.6	19.7	19.2	15.6	24.6	134	134	142
10.0	ZWxx40xx	10.6	15.7	19.9	22.7	22.5	18.9	28.1	184	184	192

## **i** Options

Heat exchanger

119 ▶



Level switch

120 ▶



Pressure transducer

120 ▶




Return line filter

118 ▶



Shown: ZW4010GB-11



 Pump accepts any industry standard D03 style directional valve. Also available with 2 station and 4 station manifolds.

## Important

Be aware of leakage rates of any valve installed on an Enerpac pump. Many standard spool valves have excessive leakage rates at higher pressures that can limit the performance of the electric pump. Be sure to consult Enerpac if you are unsure of your choice of valve.


■ **ZW5020HB-F11** with customer installed valve used to provide pressure to a clamping fixture.



## Industry standard mounting for electric or manual valves

- Highly efficient design provides increased flow rates, reduced heat generation and a decrease in power consumption
- Extensive list of accessories including
  - Heat exchanger
  - Roll-bars
  - Pressure transducer
  - Level and temperature switches
- Replaceable piston check-valves increase service life of major pump components
- Optional backlit LCD provides pump usage information, hour and cycle counts
- Also available with 2 station and 4 station manifolds

## Product selection

Output flow rate @ max. pressure	Motor size	Motor voltage	Model number	Pressure range	Sound level	Usable oil capacity	
in <sup>3</sup> /min	hp			psi	dBA	gal	lbs
40	1.0	115-1-60	<b>ZW3008GB-11</b>	1000-5000	75	2	115
		115-1-60	<b>ZW3010GB-11</b>				
		230-1-60	<b>ZW3008GI-11</b>				
		230-1-60	<b>ZW3010GI-11</b>				
60	1.0	115-1-60	<b>ZW4010GB-11</b>	1000-5000	75	2.5	120
		230-3-60	<b>ZW4010GG-11</b>				
		460-3-60	<b>ZW4010GJ-11</b>				
120	1.5	115-1-60	<b>ZW5010GB-11</b>	1000-5000	75	2.5	130
		230-3-60	<b>ZW5010GG-11</b>				
		460-3-60	<b>ZW5010GJ-11</b>				

Collet-Lok® product line  
 Swing clamps  
 Work supports  
 Linear clamps  
 Power sources

### **i** Operation – single station D03 pumps

The Single Station D03 pumps are supplied without the standard LCD electrical control. This configuration is intended to be used with user supplied controls. Control requirements include: Motor Starter or Contactor, and remote control of the pump mounted valve. Typical applications include: Special Machines and CNC Machines where the control of the pump and valve will be done by PLC or machine control.

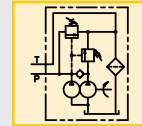
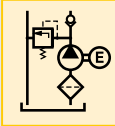
The use of the ZPF Return Line Filter is recommended. If the pump is to be run at pressure at a relief valve setting, the ZHE-E10 Heat Exchanger is also recommended. For monitoring of the oil level and temperature, use the ZLS-U4 Level/Temp Switch. For pump shutdown at pressure, the ZPS-W4 Pressure Switch Kit can provide an input to the customer supplied controls. As these accessories are designed to be used with the standard Enerpac LCD control, the customer assumes responsibility to adapt the standard leads to their controls.

**Flow: 40-120 in<sup>3</sup>/min**

**Pressure: 5000 psi max**

**Motor: 1.0 or 1.5 hp**

**Reservoir: 2.0-10.0 gal**

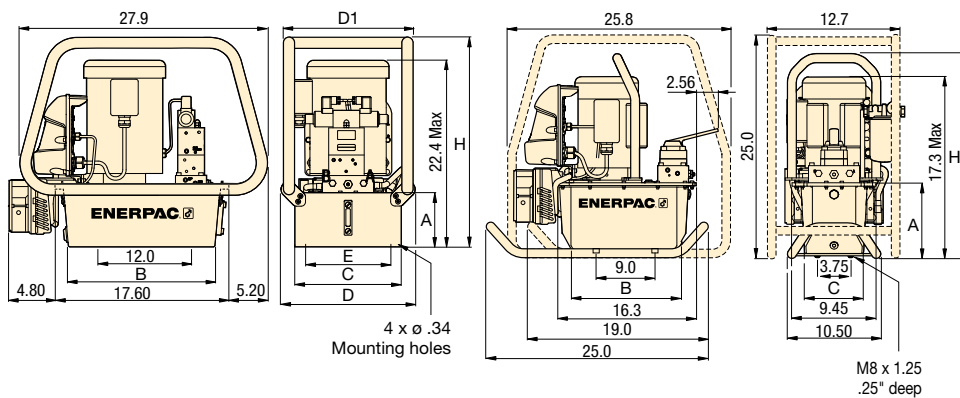
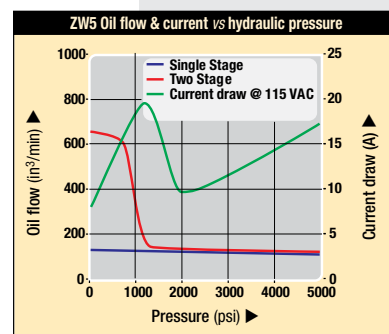
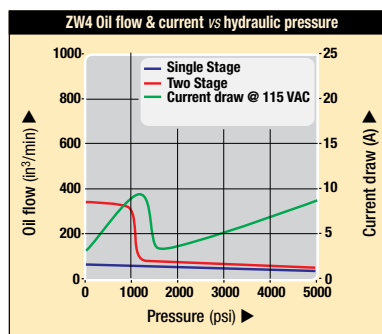
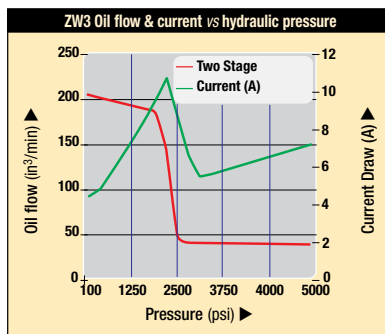


### **!** Important

**Enerpac recommends a pressure differential of no less than 200 psi for most applications. If you believe your application requires a tighter differential, please contact us directly.**

**For complete ordering matrix of all factory-installed options see page 117.**

### **i** Output oil flow and current draw



### **A** Product dimensions in inches [ ]

Usable oil capacity	Modelo number	A	B	C	D	D1	E	H	lbs		
									ZW3	ZW4	ZW5
gal											
2.0	ZWxx08xx	8.1	11.0	8.1	—	—	—	22.6	93	93	103
2.5	ZWxx10xx	6.1	16.5	12.0	15.1	14.6	11.0	23.6	107	107	115
5.0	ZWxx20xx	7.1	16.5	16.6	19.7	19.2	15.6	24.6	134	134	142
10.0	ZWxx40xx	10.6	15.7	19.9	22.7	22.5	18.9	28.1	184	184	192

### **i** Options

**Heat exchanger**  119 ▶

**Level switch**  120 ▶

**Pressure transducer**  120 ▶

**Return-line filter**  118 ▶

**VP03 solenoid valves**  141 ▶

**VMM series manual valves**  143 ▶

Shown: ZW5111SWE100



▶ Enerpac's workholding pump unit features an innovative range of zero leakage, poppet design, directional valves. With the modular valve design, various independent single-acting or double-acting circuits can be realized.

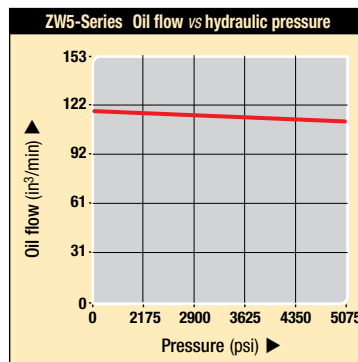
## Application

These advanced workholding pumps, operating at maximum 5000 psi hydraulic pressure, are highly suitable for production tooling applications – offering the optimum in terms of compact size for required oil flow and pressure rating and customization to your specific needs.

Enerpac electric pump used in conjunction with swing cylinders, work supports, directional valves, control valves and sequence valves can provide a complete clamping solution. The pressure switch allows the unit to be fully automated.

## Customize to your needs

- Various models including electric controls and pressure switch
- Stackable to 8 VP-series valve stations high
- Customer adjustable relief valve
- Glycerine dampened pressure gauge G-2517L on pumps with VP-series valves
- 230/460/3/50/60 Hz 1.5 hp motor



## Product selection

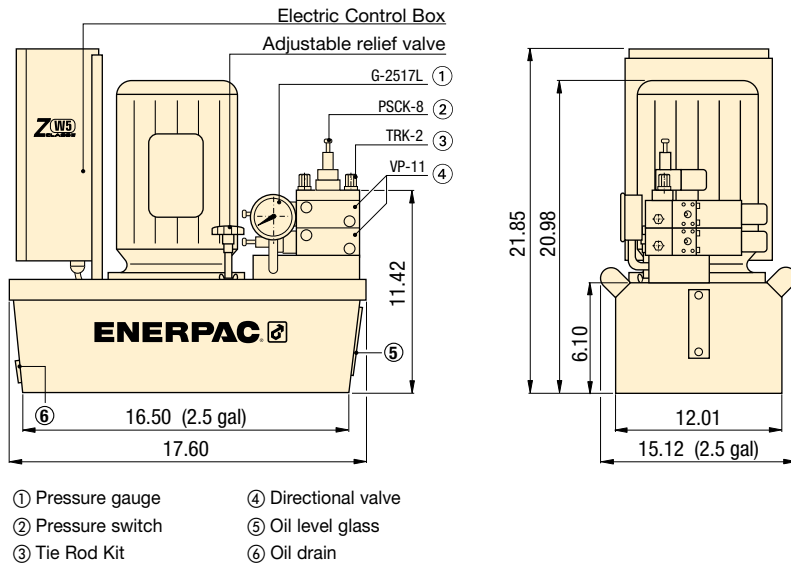
Oil flow rate	Pressure range	Voltage and current	Usable oil capacity <sup>2)</sup>	Valve models included	Model number	lbs
in <sup>3</sup> /min	psi	V @ A	gal.			
<b>▼ With manifold for VP-series modular valves, no electric controls</b>						
120	1450-5000	230 @ 4.8	2.5	–	ZW5VPSEE100	143
120	1450-5000	460 @ 2.4	2.5	–	ZW5VPSJE100	143
<b>▼ With manifold for CETOP 03 valves, no electric controls</b>						
120	1450-5000	230 @ 4.8	2.5	–	ZW5C03SEE100	143
120	1450-5000	460 @ 2.4	2.5	–	ZW5C03SJE100	143
<b>▼ For 2x single-acting circuits</b>						
120	1450-5000	230 @ 4.8	2.5	1x VP-41	ZW5141SEE100	170
120	1450-5000	460 @ 2.4	2.5	1x VP-41	ZW5141SJE100	170
<b>▼ For 1x double-acting circuits + isolating valve <sup>1)</sup> for A-port</b>						
120	1450-5000	230 @ 4.8	2.5	1x VP-11	ZW5111SEE100	170
120	1450-5000	460 @ 2.4	2.5	1x VP-11	ZW5111SJE100	170
<b>▼ For 2x double-acting circuits + isolating valves <sup>1)</sup> for all A-ports</b>						
120	1450-5000	230 @ 4.8	2.5	2x VP-11	ZW5211SEE100	176
120	1450-5000	460 @ 2.4	2.5	2x VP-11	ZW5211SJE100	176

<sup>1)</sup> Isolating valve is pressure switch PSCK-8.

<sup>2)</sup> ZW5-series pumps comes standard with 2 gallon reservoir. (1, 2, 5 or 10 gallon reservoir is optional).

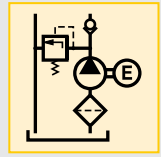


**ZW5-series** Shown: ZW5211SEE100 with standard 10 litres reservoir



- Flow:** 120 in<sup>3</sup>/min
- Pressure:** 1450-5000 psi
- Motor:** 1.5 hp
- Reservoir:** 1-10 gallon

- (E)** Bombas eléctricas
- (F)** Centrale hydraulique
- (D)** Modulare Spannumppe



**Options**

**VP-series, modular valves**  
[136 ▶](#)

**VFC-3 flow control valve (VP series)**  
[137](#)

**Pressure switches**  
[188 ▶](#)

**Hoses and couplers**  
[192 ▶](#)

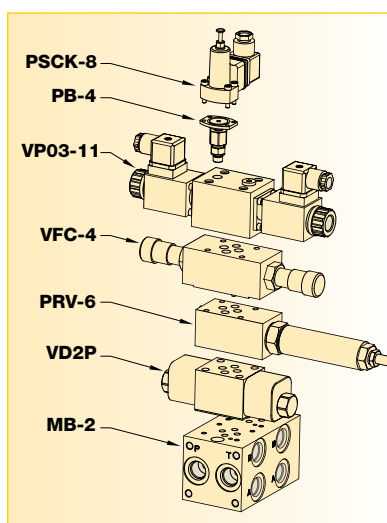
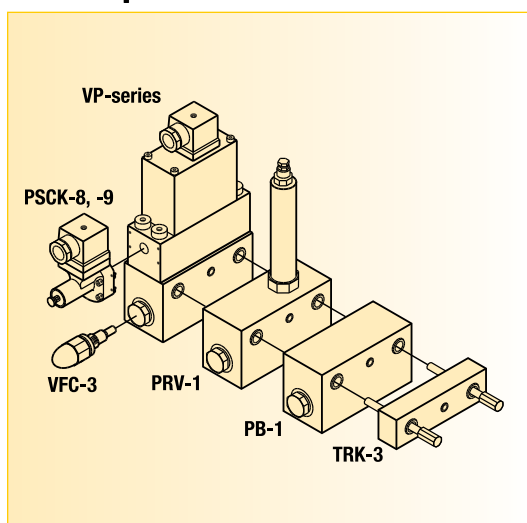
**High-pressure filters**  
[193 ▶](#)

**Fittings**  
[194 ▶](#)

**Product selection**

Pump series	Voltage	Phase	Continuous operation at 5000 psi	Motor capacity	Motor speed	Motor protection class	Sound Level
	Volt			hp	RPM		dBa
ZW5....	230	1	50%	1.5	1725	IP54	75
ZW5.....	460	3	50%	1.5	1725	IP54	75

**Valve options**



See page 136 for VP-series valves and available options.

See page 141 for VP03-series valves and available options.

Power Sources  
Valves  
Pallet Components  
System Components  
Yellow pages

Shown: ZW5111SWE100



## ZW5 series

These advanced workholding pumps, operating at maximum 5000 psi hydraulic pressure, are highly suitable for production tooling applications – offering the optimum in terms of compact size for required oil flow and pressure rating and customization to your specific needs.

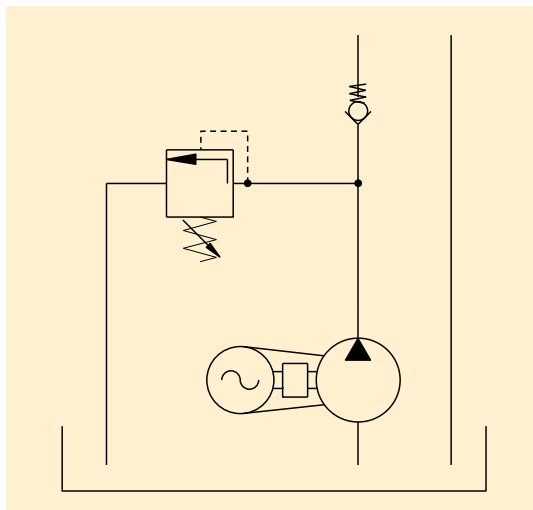
### Application

Enerpac electric pump used in conjunction with swing cylinders, work supports, directional valves, control valves and sequence valves can provide a complete clamping solution. The pressure switch allows the unit to be fully automated.

■ Enerpac VP-series valves stackbuilt on ZW5211SJE100. The pressure switch PSCK-8 is mounted directly onto the endplate of Tie Rod Kit TRK-2.



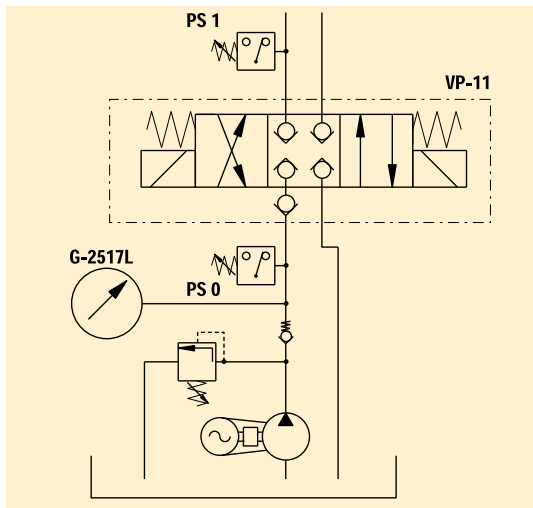
## ZW5VPSEE100 with manifold for VP-series or CETOP 03 valves, without electric controls and gauge



### Basic pumps

Customize to your needs with the Enerpac VP-series valves and options or choose your own D03 valve.

## ZW5111SEE100 For 1x Double-Acting circuit and Isolating Valve for A-port



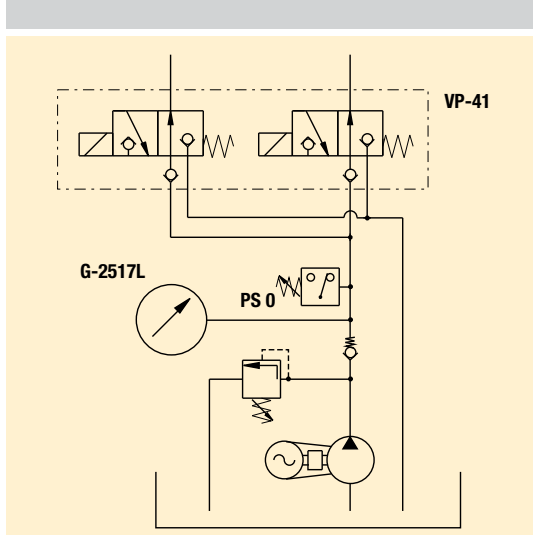
### Isolating valves

For applications where clamping pressure has to be maintained, isolating valves are an economic and safe solution.

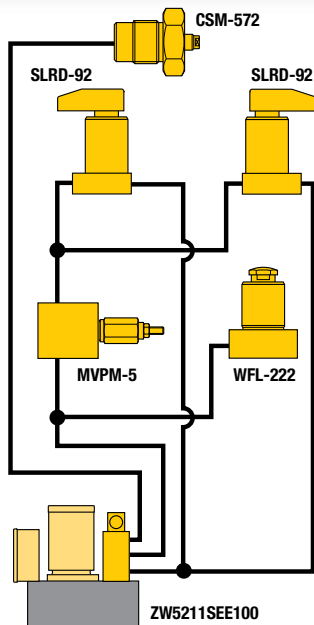
The pressure switch (PS 1) switches in the hydraulic line to the cylinder actuates the valve with a closed center position and isolates the circuit when the preset pressure has been reached. In case of pressure drop the switch opens the valve to compensate.

For some particular applications, i.e., when a workpiece has to be positioned and clamped with different forces, you can set different isolating valve pressures for the independent circuits.

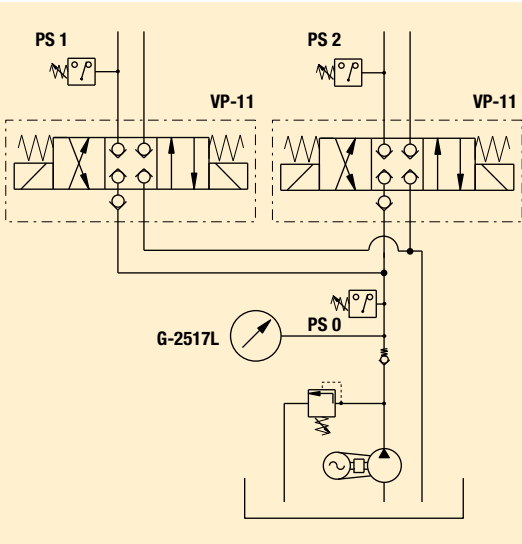
## ZW5141SEE100 For 2x Single-Acting circuits



Pressure switch (PS 0) switches the motor off at maximum pressure; in case of pressure drop due to activating circuits, the motor restarts.



**ZW5211SEE100 for 2x Double-Acting circuit and Isolating Valve for all A-ports**



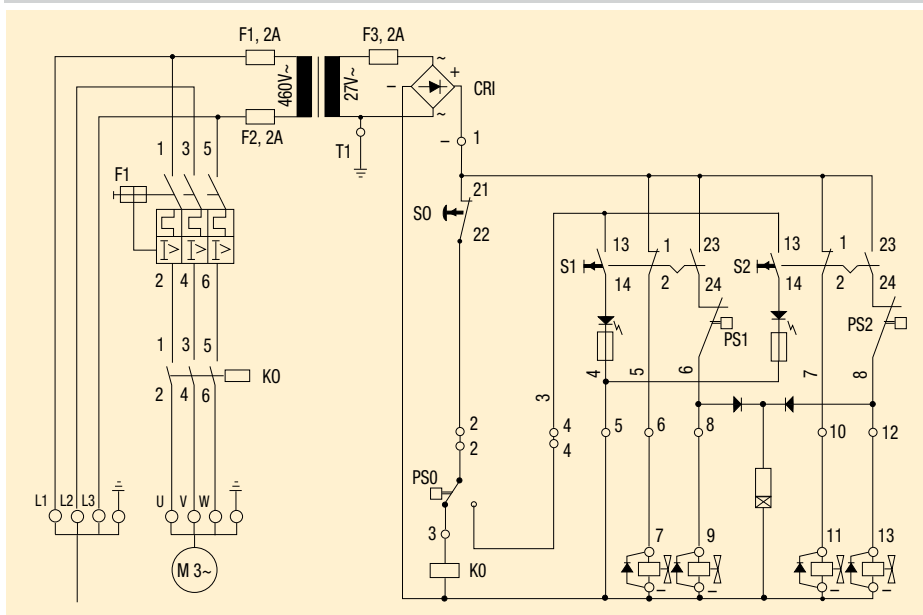
**Application example**

Building the right workholding system for a specific production tooling requirement is best achieved by observing the Basic System Set-up in our “Yellow Pages” (☐202 ▶).

**Electric Scheme**

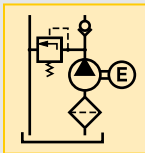
Shown the electric scheme of the ZW5211SJE100 (460 volt) for two double-acting circuits and isolating valves (pressure switches) in both A-lines.

**ZW5211SJE100**



- Flow: 120 in<sup>3</sup>/min
- Pressure: 1450-5000 psi
- Motor: 1.5 hp
- Reservoir: 1-10 gallon

- E** Bombas eléctricas
- F** Centrale hydraulique
- D** Modulare Spannumpme



**Options**

**Sequence valves**  
☐152 ▶

**Flow control valves**  
☐155 ▶

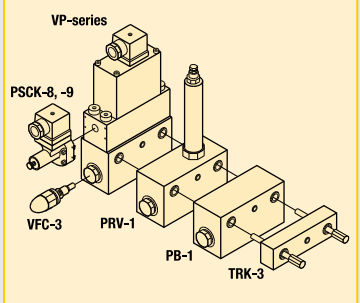
**Hoses and couplers**  
☐192 ▶

**High pressure filters**  
☐193 ▶

**Hydraulic oil**  
☐193 ▶

**Fittings**  
☐194 ▶

**VP-series valve options**  
☐136 ▶



Shown: SP-621, P-51, P-142



## P series

Single and two-speed hand operated pumps for operation of single-acting cylinders.

### SP-621 Screw pump

Single speed non-vented, internally sealed screw pump to operate single-acting cylinders. Can be mounted in any position and used to operate a single fixture. The piston is screwed into the pump, forcing the oil in the hydraulic system.

## Exclusively from Enerpac

...to power single-acting cylinders

- Internal pressure relief valve (except SP-621) prevents over-pressurization
- Two speed operation reduces handle strokes by as much as 78% over single speed pumps
- Low handle effort minimizes operator fatigue
- Compact size – enables easy conversion of manual fixtures to hydraulic power

Flow: .055-.25 in<sup>3</sup>/stroke

Pressure: 3000-10,000 psi

Reservoir: 6.2-55 in<sup>3</sup>

**E** Bombas manuales

**F** Pompes à main

**D** Handpumpen



## Options

### Fittings

194 ▶



### Hoses

192 ▶



### Hydraulic oil

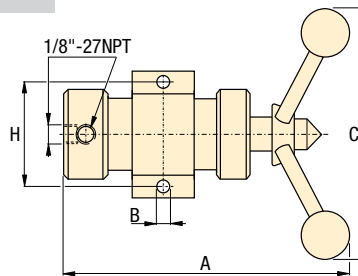
193 ▶



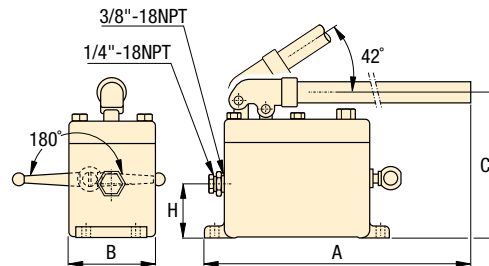
## Important

**P-141, P-142 and P-202 are designed for a maximum operating pressure of 10,000 psi.**

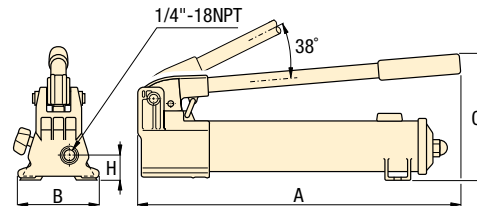
SP-621



P-51



P-141, -142, -202



## Product selection

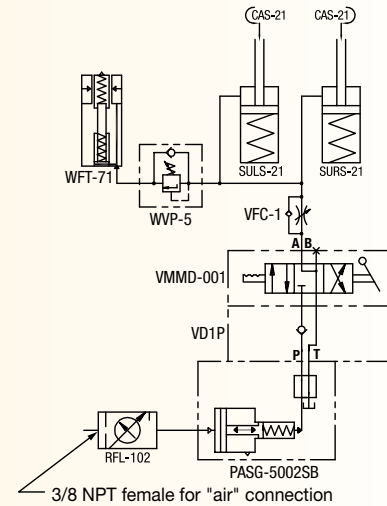
Maximum hydraulic pressure	Usable oil capacity	Model number	Pressure rating		Oil volume per stroke		Piston stroke	Maximum handle effort	Dimensions (inches)				Weight
			psi	psi	in <sup>3</sup>	in <sup>3</sup>			A	B	C	H	
psi	in <sup>3</sup>		1st stage	2nd stage	1st stage	2nd stage	in	lbs	A	B	C	H	lbs
<b>▼ Single speed</b>													
3000	6.2	SP-621	–	3000	–	<sup>1)</sup>	<sup>1)</sup>	60 <sup>2)</sup>	10.10	.41	12.40	2.81	7.0
3000	50	P-51	–	3000	–	.25	1.00	61	26.00	3.63	6.31	2.25	12.0
10,000	20	P-141	–	10,000	–	.055	.50	72	13.25	3.75	5.63	1.13	4.5
<b>▼ Two speed</b>													
5000	20	P-142	200	10,000	.221	.055	.50	78	13.25	3.75	5.63	1.13	4.5
5000	20	P-142-5000	200	5,000	.221	.055	.50	78	13.25	3.75	5.63	1.13	4.5
10,000	55	P-202	200	10,000	.221	.055	.50	63	20.06	3.75	5.69	1.13	7.5

1) Handle travel of SP-621 is 2.50 inches; 25 handle rotations displace 6.2 in<sup>3</sup> of oil.  
2) Handle effort on SP-621 is 60 ft.lbs at 3000 psi.

Collet-Lok® product line  
Swing clamps  
Work supports  
Linear clamps  
Power sources

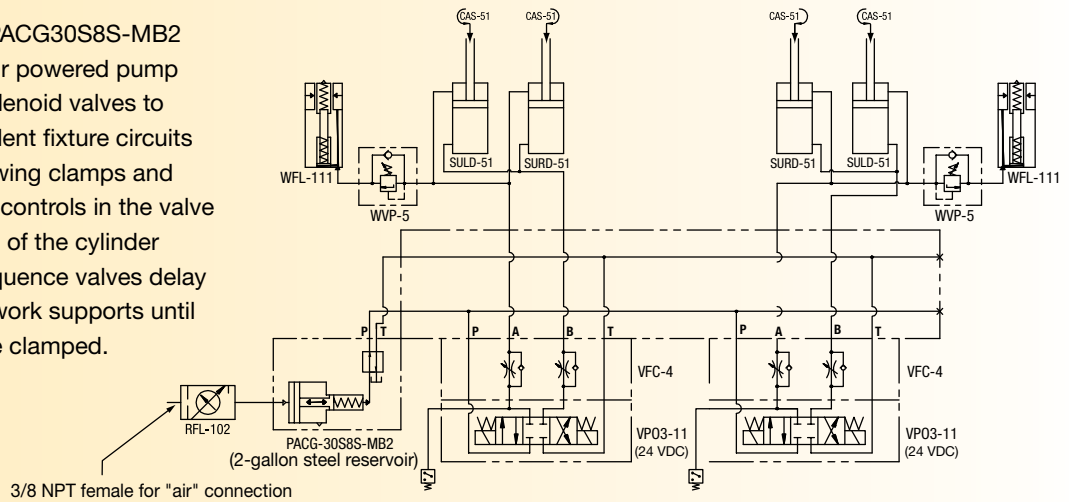
## Air Powered Pump with Manual Valve

This system uses a PASG5002SB Turbo II air powered pump with a VMMD-001 manual valve to control a fixture circuit with single acting swing clamps and work supports. A VDP-1 check module in the valve stack locks the pressure in the system. A WVP-5 sequence valve delays the actuation of the works support until the swing clamp is clamped.



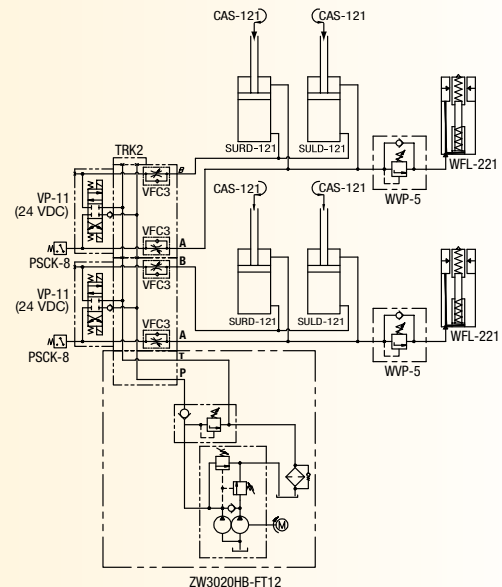
## Air Powered Pump with Dual Solenoid Valves

This system uses a PACG30S8S-MB2 Two gallon Turbo II air powered pump with two VP03-11 solenoid valves to control two independent fixture circuits with double acting swing clamps and work supports. Flow controls in the valve stack provide control of the cylinder actuation speed. Sequence valves delay the actuation of the work supports until the swing clamps are clamped.



## Electric Pump with Dual Solenoid Valves

This system uses a ZW3020HB-FT12 electric pump and two VP-11 solenoid valves to control two independent fixture circuits with double acting swing clamps and work supports. Flow controls mounted in the valves provide control of the cylinder actuation speed. Pressure switches on the "clamp" circuit can provide confirmation of clamping pressure. Sequence valves delay the actuation of the work supports until the swing clamps are clamped.



# Valves

## Technical support

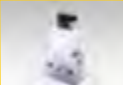
















Refer to the “Yellow Pages” of this catalog for:

- Safety instructions
- Basic hydraulic information
- Advanced hydraulic technology
- FMS (Flexible Machining Systems) technology
- Conversion charts and hydraulic symbols

 197 ▶

Controlling the operation of your clamping system requires the use of many specialized directional, pressure and flow control valves. Enerpac has the complete line of valving components to complement any hydraulic system. Choose from either manual or electric directional valves, and a wide variety of pressure control, flow control and specialty valves to provide the control and automation that your application needs.



	▼ series	▼ page	
Solenoid modular poppet valve	VP	136	
Pressure switches, Flow control valve	PSCK VFC	137	
Pressure reducing valve	PRV	138, 154	
Tie rod kits, Remote/porting manifolds	TRK WM/PB	139	
Solenoid/Air operated 2-position poppet valves	VA, VS, VD	140	
Solenoid poppet, D03/CETOP3	VP03	141	
Solenoid D03 spool valves and accessories	VE	142	
Manual, D03/CETOP3 valves	VMM VMT	143	
Valve manifolds	MB	144	
Solenoid modular valves	VE	146 - 147	
3-Way directional manual control valves	V	148 - 149	
4-Way directional manual control valves	V	150 - 151	
Sequence valves	MVP WVP, V	152	
Pilot operated check valves	MV, V	153	
Flow control valves	VFC	155	
Accessory valves	MH, HV PLV, V	156 - 157	
Air valves and accessories	V, VA, VAS, VR, RFL, QE	158 - 159	

Shown: VP-12



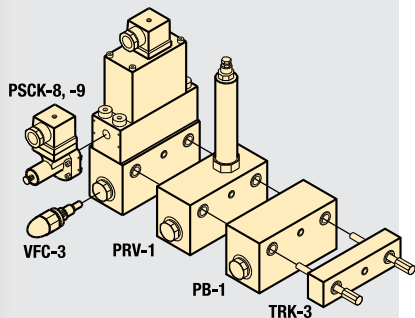
## VP-series

Solenoid directional valves control the direction of the oil flow to each cylinder port.

### Application

With the use of a -12 manifold, these valves allow quick and easy assembly of hydraulic control valves on your Enerpac ZW-series pump. For remote mounting of these valves use a WM-10 manifold.

### VP-series



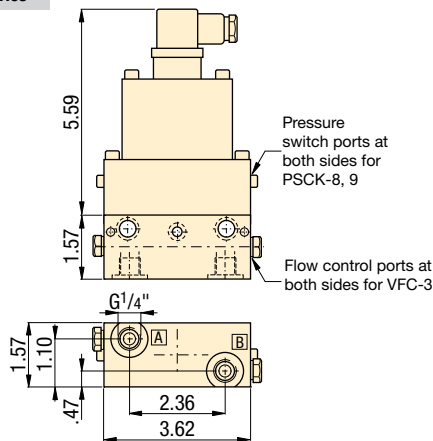
■ Enerpac VP-series valves mounted on -12 manifold, mounted on a ZW-series workholding pump.



## Solenoid directional valves

- Dual poppet valve design for zero internal leakage
- Inlet check-valve standard
- High cycle switching
- Stackable to 8 valve stations high
- 250-5000 psi operational pressure
- Oil flow capacity 427 in<sup>3</sup>/min @ 5000 psi
- Oil flow capacity 915 in<sup>3</sup>/min @ 0 psi
- G1/4" oil connections and integrated filtration
- 24 VDC and 110 VAC available

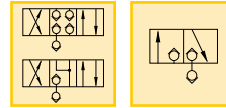
### VP series



Pressure: 5000 psi

Max. Flow: 915 in<sup>3</sup>/min

- Ⓔ Válvulas de control
- Ⓕ Electro distributeurs
- Ⓖ Wegesitzventile



## Options

### WM-10 series manifolds

▣ 139 ▶

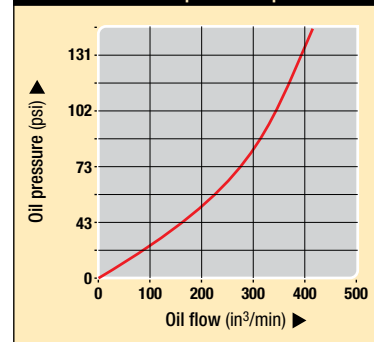


### Tie rod kits

▣ 139 ▶



### Oil flow vs pressure drop



## Product selection

Voltage @ current	Model number	Flow path	Used with cylinder(s)
at 50/60 Hz			
<b>▼ 4/3 Closed center</b>			
24 VDC @ 1.13 A	<b>VP-11</b>		1x Dbl-act.
110 VAC @ 500 mA	<b>VP-12</b>		1x Dbl-act.
<b>▼ 4/3 Float center</b>			
24 VDC @ 1.13 A	<b>VP-21</b>		1x Dbl-act.
110 VAC @ 500 mA	<b>VP-22</b>		1x Dbl-act.
<b>▼ 3/2 Normally closed</b>			
24 VDC @ 1.13 A	<b>VP-31</b>		1x Dbl-act. / 2x Sgl-act.
110 VAC @ 500 mA	<b>VP-32</b>		1x Dbl-act. / 2x Sgl-act.
<b>▼ 3/2 Normally open</b>			
24 VDC @ 1.13 A	<b>VP-41</b>		1x Dbl-act. / 2x Sgl-act.
110 VAC @ 500 mA	<b>VP-42</b>		1x Dbl-act. / 2x Sgl-act.
<b>▼ 3/2 1 port normally closed, 1 port normally open</b>			
24 VDC @ 1.13 A	<b>VP-51</b>		1x Dbl-act. / 2x Sgl-act.
110 VAC @ 500 mA	<b>VP-52</b>		1x Dbl-act. / 2x Sgl-act.

Note: DIN 43650 electrical connector included. Valve weight 6.5 lbs (3,0 kg.).



# PSCK, VFC-series Pressure switches, Flow control valve

Pressure: 5000 psi

Flow: 427 in<sup>3</sup>/min @ 5000 psi

Voltage: 115 VAC, 24 VDC

- E** Presostatos
- F** Pressostats
- D** Druckschalter



## To control your hydraulic system

- Mounts directly into VP-series modular valves
- In-line installation
- Cartridge type flow control valve and pressure switches can be manifold mounted for remote use
- Lockable adjustment screw on PSCK models

Shown: PSCK-8, VFC-3



## Options

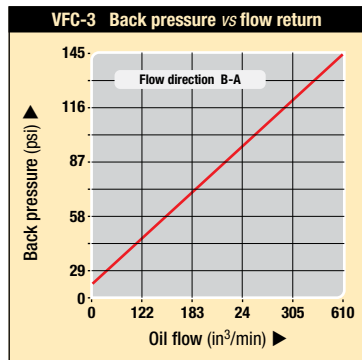
**PB-1 Auxiliary block**

139 ▶



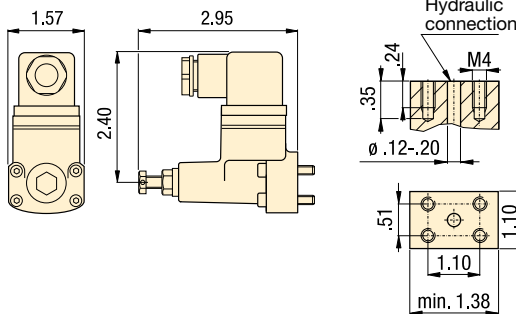
**Pressure reducing valves**

138 ▶



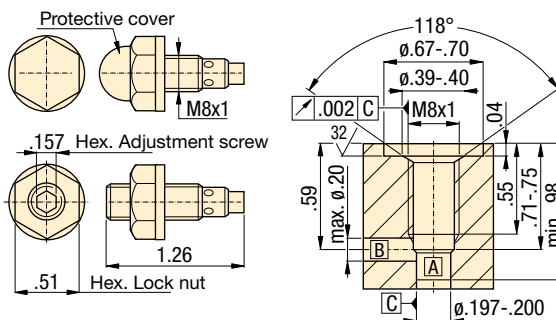
PSCK-8, 9

PSCK-8, 9 mounting dimensions



VFC-3

VFC-3 mounting dimensions



## Product selection

Solenoid voltage @ current	Model number	Hydraulic scheme	Pressure range	Deadband	Maximum oil flow
at 50/60 Hz			psi	psi	in <sup>3</sup> /min
▼ Pressure switch					
24 VDC @ 2 A	PSCK-8		1450 - 5000	261 - 501	427
115 VAC @ 2 A					
▼ Pressure switch					
24 VDC @ 2 A	PSCK-9		290 - 3045	87 - 218	427
115 VAC @ 2 A					
▼ Flow control valve					
screw-in	VFC-3		0-5000	-	427
throttle valve					
valve					

## PSCK-8, 9

Adjustable pressure switches will open or close electrical contacts when the desired pressure value is reached.

### Application

To open or close an electric circuit when a preset pressure value is reached. The electrical circuit is used to control further working cycles, such as actuating control valves or to terminate a working cycle. Directly mounted into Enerpac VP-series valves.

## VFC-3

Screw-in throttle type valve to control the amount of oil flow to the hydraulic cylinder.

### Application

Used to control cylinder speed in hydraulic circuits. Directly mounted into Enerpac VP-series valves or custom made manifolds for remote applications.

■ PSCK-8 and VFC-3 directly mounted on VP-valves.



Shown: PRV-1



## PRV series

These valves regulate system pressure for all subsequent valves, according to the adjusted pressure. Maintains a constant pressure in a secondary circuit. Includes a check valve that prevents pressure drop on secondary side.

### Application

Used when a hydraulic supply with a higher pressure (primary side) must also be used for another circuit with a lower pressure (secondary circuit). PRV-1 can be stack built between VP-series valves.

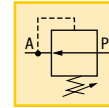
## Precise control of hydraulic pressure

- Stackbuilding with VP series modular valves
- Stackable for multiple pressures on one valve stack assembly
- Tool adjustable knob can be locked
- Precise control of pressure

Pressure: 5000 psi

Flow: 417 in<sup>3</sup>/min

- Ⓔ Válv. reguladora de presión
- Ⓕ Valve de pression réglable
- Ⓖ Druckreduzierventil



## Options

### VP-Modular valves

136 ▶



### Pressure switches

188 ▶

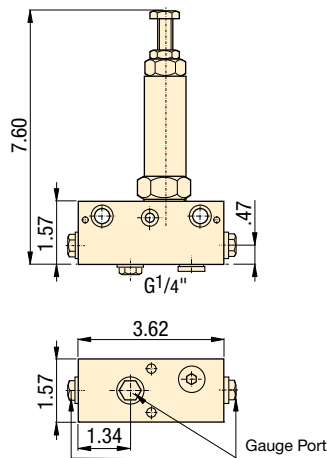


### Tie rod kits

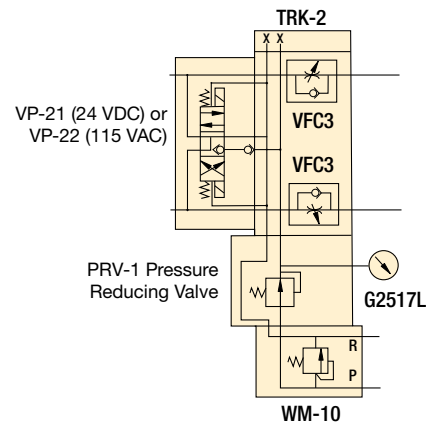
139 ▶



### PRV-1, PRV-5



### Valve stacking example



■ PRV-1 connected with remote manifold WM-10.



## Product selection

Mounting style	Adjustable pressure range	Maximum pressure	Model number	Oil ports	Maximum oil flow	
	psi	psi		BSPP	in <sup>3</sup> /min	lbs
VP-series	435 - 4350	5000	PRV-1	G1/4"	427	3.5
VP-series	75 - 2000	5000	PRV-5	G1/4"	427	3.5

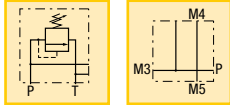
# TRK, WM/PB-series Tie rod kits, Remote/porting manifolds

Mounting: 1-8 VP valve stations

Pressure: 5000 psi max.

Flow: 915 in<sup>3</sup>/min

- E** Pernos de montaje de válv.
- F** Vis de montage de distrib.
- D** Zugstangen



## Options

Pressure switches

188 ▶



VP-series directional valves

130 ▶

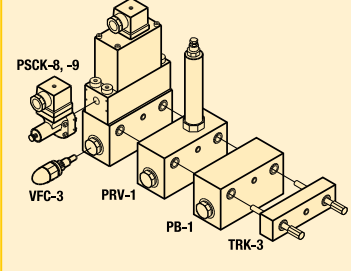


Gauges

189 ▶



VP-series



## Simplifies valve and accessory mounting

### TRK-series tie rods

- Connects 1 to 8 VP-series valves station high
- Provide leak-free sealing valves
- G1/4" oil connection

### WM-10 remote manifold

- Allows remote VP-series valve mounting
- Adjustable relief valve incorporated
- G1/4" oil connection

### PB-1 porting manifold

- Provide 3 auxiliary pressure lines
- G1/4" oil connection

Shown: WM-10, TRK-4, PB-1



### TRK-series

Tie Rod Kits mount Enerpac VP-series modular valves to the WM-10 manifold and can accommodate one to eight VP-valve stations.

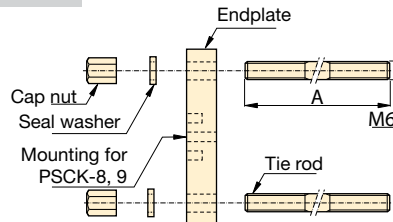
### WM-10

Remote manifold allows mounting of VP-series modular valves to a remote location from the pumping unit. This manifold has a built-in adjustable relief valve.

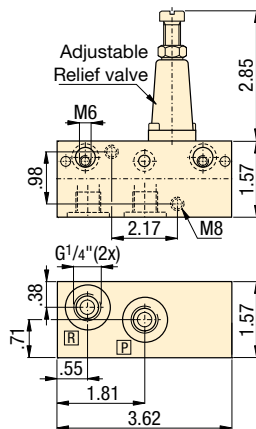
### PB-1

Porting manifold provides three pressure ports for auxiliary lines or accessories, such as a pressure gauge. Mounts between VP-series modular valve stations using TRK-series tie rod kits.

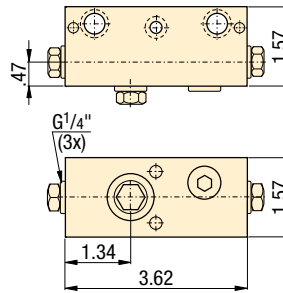
### TRK



### WM-10



### PB-1



## Product selection

Quantity of stackable VP-series directional valves	Model number	Tie rod length	Mounting thread
		A	
		inch	mm

### ▼ Tie rod kits

1	TRK-1	3.45	M6
2	TRK-2	4.92	M6
3	TRK-3	6.50	M6
4	TRK-4	8.07	M6
5	TRK-5	9.65	M6
6	TRK-6	11.22	M6
7	TRK-7	12.80	M6
8	TRK-8	14.37	M6

## Product selection

Oil ports	Model number	Hydraulic schematic	Maximum pressure
			psi

### ▼ Remote manifold with pressure relief

2x G1/4"	WM-10		5000
----------	-------	--	------

### ▼ Porting manifold (P port connection)

3x G1/4"	PB-1		5000
----------	------	--	------

Shown: VST-1401D, VSS-2210D



## VSS, VST-series

Solenoid and air piloted directional control valves. Poppet design for zero leakage promote system efficiency. Increases the life of your workholding pump by decreasing internal valve leakage.

### Application

Advance and retract for single- and double-acting cylinders. The valves require check valves for positive load holding and can be installed for the same independent operation with single-acting cylinders by blocking the B port.

## Zero leakage poppet valves increase efficiency

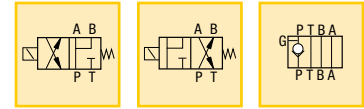
- Poppet valve design for zero leakage
- 4-way, 2-position float offset or normally open
- D03 or CETOP3 mounting pattern
- DIN-standard rectifier plugs for easy connection to power source
- Air operated models eliminate need for electricity
- Including O-rings and mounting bolts
- SAE manifold ports simplify plumbing
- Inline check valve provides positive load holding

Pressure: 0-5000 psi

Flow: 690 in<sup>3</sup>/min max.

Voltage: 115 VAC, 24 VDC

- E** Electroválvulas
- F** Electro distributeurs
- D** Elektromagnetische Ventile



## Options

### D03 Manifolds MB-series

144 ▶



### Fittings

194 ▶

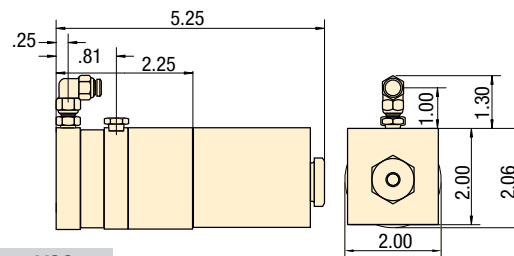


## Important

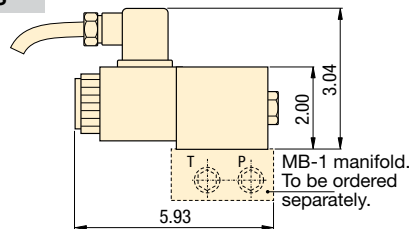
For multiple circuit applications, the VD1P inline check valve is recommended to prevent pressure drop on the holding circuit.

Order bolt kit BKD-71 to mount VD1P with VAS/VSS/VST valves.

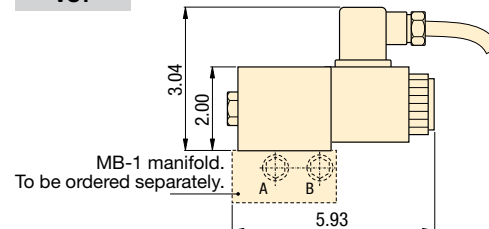
### VAS/VAT



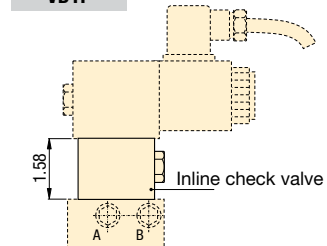
### VSS



### VST



### VD1P



## Product selection

Valve flow path	Solenoid voltage @ current at 50/60 Hz	Model number	Hydr. symbol	Pressure range psi	Pressure drop <sup>1)</sup> psi	Max. oil flow in <sup>3</sup> /min
<b>▼ Solenoid poppet valves – Normally open</b>						
4-way, 2 position	60-100 psi max.	VAS-0710D		0-5000	180	690
4-way, 2 position	24VDC @ 1.60 A	VSS-1410D		0-5000	180	690
4-way, 2 position	115VAC @ .40 A	VSS-2210D		0-5000	180	690
<b>▼ Solenoid poppet valves – Normally closed</b>						
4-way, 2 position	60-100 psi max.	VAT-0710D		0-5000	180	690
4-way, 2 position	24VDC @ 1.60 A	VST-1410D		0-5000	180	690
4-way, 2 position	115VAC @ .40 A	VST-2210D		0-5000	180	690
<b>▼ Inline check valve</b>						
-	-	VD1P		0-5000	0	690

<sup>1)</sup> Pressure drop from P-A or P-B at maximum oil flow of 690 in<sup>3</sup>/min.

■ VSS-2210D mounted directly on a Turbo II air pump for use on positive clamping fixture.



Collet-Lox® product line  
Swing clamps  
Work supports  
Linear clamps  
Power sources  
Valves

Pressure: 0-5000 psi

Flow: 3-15 gpm

Voltage: 24 VDC, 110 VAC

- E** Electroválvulas
- F** Electro distributeurs
- D** Elektromagnetische Ventile

## Options

D03 Manifolds  
MB-series

144 ▶



Fittings

194 ▶



## VP03 Directional Valves and accessories

- D03/CETOP 3 mounting pattern
- Directional valves
- Pilot operated check valve
- Dual flow control
- Pressure reducing valve

Shown: VP03



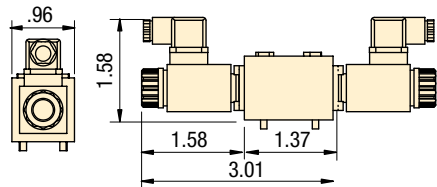
## VP03-series

VP03 valves are zero leakage, solenoid operated poppet valves.

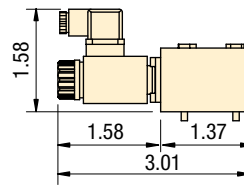
### Application

Used to control the advance and retract of single acting and double acting cylinders.

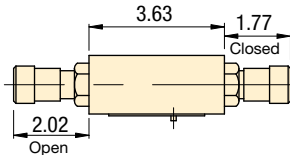
VP03-11, 12, 21, 22



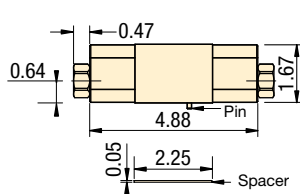
VP03-51, 52



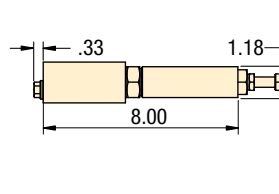
VFC-4



VD2P



PRV-6, PRV-7



## Product selection

Valve flow path	Solenoid voltage 50/60 hz	Model number	Hydraulic symbol	Pressure range	Maximum oil flow
				psi	gpm
3-position/4 way, Closed center	24 VDC	VP03-11		0-5000	5
	110 VAC	VP03-12		0-5000	5
3-position/4 way, Float center	24 VDC	VP03-21		0-5000	5
	110 VAC	VP03-22		0-5000	5
2-position/4 way	24 VDC	VP03-51		0-3626	4
	110 VAC	VP03-52		0-3626	4
Dual flow control	-	VFC-4		0-5000	10
Dual pilot operated check valve	-	VD2P		0-5000	15
Pressure reducing valve	-	PRV-6		435-4350	3.2
	-	PRV-7		75-2000	1.6

## Important

VP03 series valves are zero leakage and can be used with pressure shut down electric pumps and air driven Turbo II pumps.

VP03-11 valve on PASG-3002SB Turbo pump.



Shown: VEX-11 valve



## VE-series

Spool style solenoid valves and control modules are used in circuits that do not require zero leakage.

### Application

Used to control the advance and retract of single acting and double acting cylinders. The dual check valve can be used to lock pressure in a group of cylinders. The dual flow control offers independent control of cylinder advance and retract speeds. The pressure reducing valve sets a circuit pressure lower than the main pump pressure.

## D03 Direction Valve and accessories

- D03 mounting pattern
- Directional valves
- Pilot operated check valve
- Dual flow control
- Pressure reducing valve

Pressure: 0-5000 psi

Flow: 3-15 gpm

Voltage: 24 VDC

- (E) Electroválvulas
- (F) Electro distributeurs
- (D) Elektromagnetische Ventile

### Options

D03 Manifolds MB-series

144 ▶



Fittings

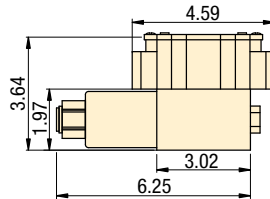
194 ▶



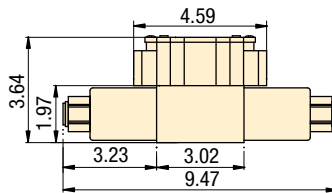
### Important

To hold the pressure in a clamping circuit, use the VEX11 valve with the VD2P check module. Do not use D03 spool valves with pressure shutdown pumps.

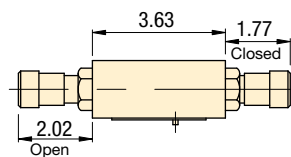
VEW-11



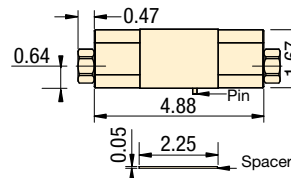
VET-11, VEX-11



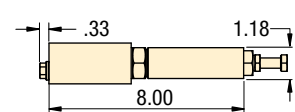
VFC-4



VD2P



PRV-6, PRV-7



## Product selection

Valve flow path	Solenoid voltage 50/60 hz	Model number	Hydraulic symbol	Pressure range	Pressure drop	Maximum oil flow
				psi	psi	gpm
2-position/4 way	24 VDC 1.32 Amps	VEW-11		0-5000	125	8
3-position/4 way, Closed center	24 VDC 1.32 Amps	VET-11		0-5000	150	8
3-position/4 way, Float center	24 VDC 1.32 Amps	VEX-11		0-5000	165	8
Dual flow control	-	VFC-4		0-5000	-	10
Dual pilot operated check valve	-	VD2P		0-5000	200	15
Pressure reducing valve	-	PRV-6 / PRV-7		435-4350 75-2000	-	3

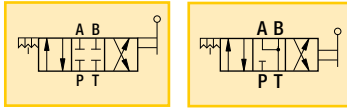
■ VEX-11 valve on ZW5020HG-FT21 pump.



Pressure: 5000 psi

Flow: 1040 in<sup>3</sup>/min

- E** Válvulas de control de 4 vías
- F** Distributeurs à 4 voies
- D** 4-Wege-Ventiler



## Options

**VD1P, Inline check valve**

◀ 140

**D03 Manifolds**

144 ▶

**Hoses and couplers**

192 ▶

**Fittings**

194 ▶

## Important

For multiple circuit applications, the VD1P inline check valve is recommended to prevent pressure drop on the holding circuit.

See page 145 for mounting bolt information.

Pressure on return side (tank) should not exceed 250 psi.

## Product selection

Valve mounting pattern	Mounting bolts included	Oil ports	Model number	Hydraulic symbol	Pressure range	Pressure drop <sup>1)</sup>	Max. oil flow
					psi	psi	in <sup>3</sup> /min
<b>▼ 4-way, 3-position control valves</b>							
Panel mtg.	-	SAE #4	<b>VMTD-001</b>		0-5000	70	1040
D03/CETOP 3	#10-24UN	-	<b>VMMD-001</b>		0-5000	70	1040
Panel mtg.	-	SAE #4	<b>VMTD-003</b>		0-5000	70	1040
D03/CETOP 3	#10-24UN	-	<b>VMMD-003</b>		0-5000	70	1040

<sup>1)</sup> Pressure drop from P-A or P-B at maximum oil flow of 1040 in<sup>3</sup>/min. Seal material: Buna-N, Polyurethane.

## Manual control of single and double-acting cylinders

- Near zero leakage pressure seal design
- 4-way, 3-position
- Detented handle positions
- Low handle effort 12 lbs, even at full pressure
- Handle can be repositioned for side by side valve mounting
- Compact size for directly mounting on fixture for individual circuit control
- D03/CETOP 3 mounting pattern

Shown: VMMD-001, VMTD-001



## VMM and VMT-series

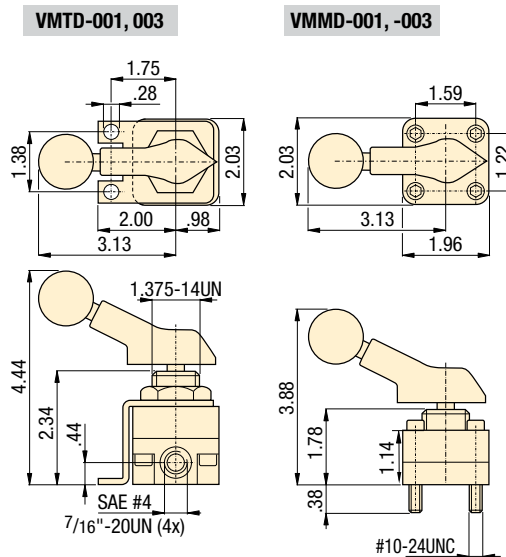
Manual directional control valves for single- and double-acting cylinder control. Lapped pressure seal surface provide near zero leakage.

The VMTD series has threaded port connections and removable holding bracket for panel mounting.

## Application

Panel mounting on fixtures for control of individual circuits. The blocked pressure port in the center position allows demand style pumps to stall out, saving energy.

The valves require check valves for positive load holding.



■ Several VMTD-001 valves mounted on fixture waiting to be transferred to machine.



Shown: MB-4, MB-1



## MB-series

Single or multiple station manifolds allow installation of VSS and VST-series positive seal control valves or other D03/CETOP 3 valves. Ideal in applications where independent control of multiple cylinders is required.

## Important

Use MC-1 (D03) / MC-3 (CETOP 3) cover plates to seal non-used manifold stations.

Each non-used valve station on manifolds must be sealed with MC-1 cover plate.



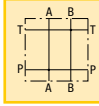
## When independent control of multiple cylinders is required

- Multi-station manifolds with SAE or CETOP 3 porting – minimizes plumbing
- Mounting patterns for: VSS/VST Valves (D03 or CETOP 3); VE Valves (D03 or CETOP 3); VP03 Valves (D03 or CETOP 3); VMMD Valves (D03 or CETOP 3)
- Manifolds allow use of accessories, such as pressure switches and gauges

Mounting: 1-4 valves

Pressure: 5000 psi max.

- (E) Colectores
- (F) Manifolds
- (D) Verkettungsblöcke



## Options

VSS, VST-series valves

140 ▶



Pressure switches

188 ▶



Gauges and accessories

190 ▶



Fittings

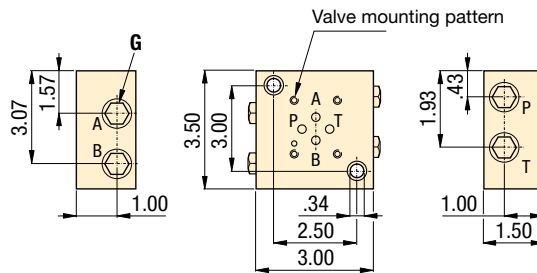
194 ▶



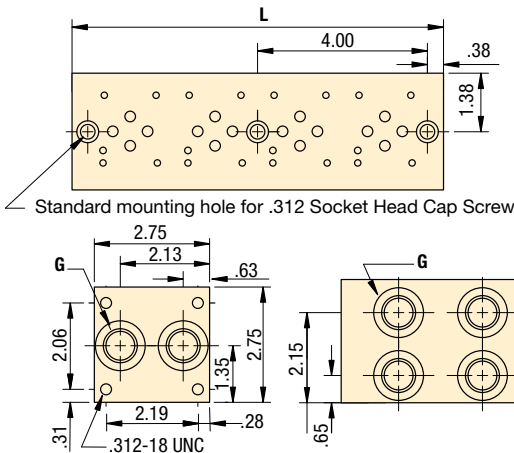
## Important

Use MC-1 / MC-3 cover plates to seal unused manifold stations.

MB-1



MB-2, -4



## Product selection

Valve mounting pattern	Number of valve stations	Model number	Oil ports cover plate	Coverplate model number*	Manifold	Weight
			G		L	lbs
<b>▼ Single station manifold</b>						
D03	1	MB-1	SAE #4	-	-	1.0
CETOP 3	1	MB-12	G1/4"	-	-	1.0
<b>▼ Multiple station manifolds</b>						
D03	2	MB-2	SAE #8	MC-1	4.75	3.3
CETOP 3	2	MB-22	G3/8"	MC-3	4.75	3.3
D03	4	MB-4	SAE #8	MC-1	8.75	6.1
CETOP 3	4	MB-42	G3/8"	MC-3	8.75	6.1

\*Note: - MC-1 manifold cover plate must be ordered separately. Includes gasket and mounting bolts.



- E** Kits de fijación para válvulas
- F** Kits de montage robinet
- D** Zugstangen-Satz

## Options

### VD1P, Inline check valve

◀ 140

### D03 Manifolds

◀ 144



### Hoses and couplers

192 ▶



### Fittings

194 ▶



## Important

The mounting stud must project into the manifold a minimum of .375" (9,5 mm). After installation, torque the stud nuts to 45 in-lbs (5 Nm)

To calculate the required stud length, add the stud length for the directional valve and each accessory module used in the valve stack. Add .78" (19,81 mm) to this length. The mounting studs should be cut to this total length.

## Use Stud Bolt Kits to assure the correct bolt length

- Studs are easily cut to length
- Stud nuts make installation easier
- Pre-mount the studs into the manifold to help guide the valve components into place

Shown: BKD71, BKD72



## BKD-series

Always have the right bolt length required to mount the components in your valve stack by using these stud bolt kits.

Refer to chart to determine the required bolt length

## Example

Description	Model number	Stud Length	
		in	mm
Directional valve	VP03-11	1.87	47,49
Dual flow control	VFC-4	1.57	39,88
Dual P.O. check	VD2P	1.57	39,88
Stud nut	VD2P	0.40	10,16
Manifold	V-19	0.38	9,65
<b>Total length:</b>		<b>5.79</b>	<b>147,06</b>

## Product selection

Description	Model number	Stud Length	
		in	mm
Imperial stud kit (#10-24)*	BKD71	7.00	—
Metric stud kit (M5)*	BKD72	—	177,80
<b>▼ Valve mounting bolt lengths using stud kits</b>			
Stud Nut	BKD71, BKD72	0.40	10,16
Manifold	MB1, MB2, MB3	0.38	9,65
Solenoid valve	VAS/VSS/VST	1.63	41,40
Solenoid valve	VEV/VET/VEX	1.25	31,75
Solenoid valve	VP03	1.87	47,49
Manual valve	VMMD001/VMMD003	1.13	28,70
Pressure Reducing Valve	PRV6/PRV7	1.57	39,88
Check valve, on "P"	VD1P	1.57	39,88
Dual P.O. check valve	VD2P	1.57	39,88
Dual flow control	VFC-4	1.57	39,88

\*Note: Stud kit includes 4 studs and 4 stud nuts

Shown: VEC-15600D, VEC-15000B, VEK-15000B



## VE-series

Solenoid modular valves are especially well suited for workholding and production applications. With 11 possible flowpaths and 2 manifolds, for either Enerpac's submerged pump or a remote NPT mount, you can "custom build" a valve for almost any application.

### Application

Ideal when mounted on remote manifold for applications where independent control of multiple cylinders is required.

## Unmatched combination of possibilities

- Relief valve and pilot-operated check accessory valves are stackable eliminating external plumbing
- Remote and pump mounting
- Mounting bolts included with each modular valve

## Select the required valve flow path

Valve flow path	For cylinder	Valve code	Hydraulic symbol
<b>▼ 2-way, 2-position (2/2)</b>			
Normally closed	Unloading *	<b>VEH</b>	
Normally open	Unloading *	<b>VEK</b>	
<b>▼ 3-way, 2-position (3/2)</b>			
Normally open	Single-acting	<b>VEP</b>	
<b>▼ 3-way, 3-position (3/3)</b>			
Tandem center	Single-acting	<b>VEF</b>	
Closed center	Single-acting	<b>VEG</b>	
<b>▼ 4-way, 2-position (4/2)</b>			
Crossover offset	Double-acting	<b>VEE</b>	
Float offset	Double-acting	<b>VEM</b>	
<b>▼ 4-way, 3-position (4/3)</b>			
Open center	Double-acting	<b>VEA</b>	
Closed center	Double-acting	<b>VEB</b>	
Tandem center	Double-acting	<b>VEC</b>	
Float center	Double-acting	<b>VED</b>	

\* VEH and VEK valve models require the use of tank port for dump or unloading.

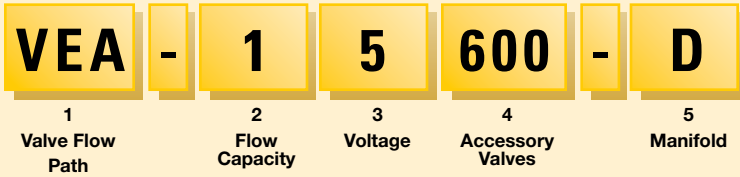
## Product specifications

Pressure range	Maximum oil flow	Voltage @ Hz	Amperage draw	
			inrush	holding
psi	in <sup>3</sup> /min			
0-10,000	920	24 VDC @ 50/60 Hz	-	2.5
0-10,000	920	115 VAC @ 60 Hz	3.6	1.0
0-10,000	920	220/240 VAC @ 50 Hz	1.3/1.4	.45/.53
0-10,000	920	230 VAC @ 60 Hz	1.8	.50 A

**Note:** Seal material: Buna-N, Polyurethane.  
DIN43650 Valve plug included on remote mounted valves.

**Custom build your modular valves**

▼ This is how a Solenoid Modular Valve Model Number is built up:



**1 Modular valve code**

- A = 4/3 Open center
- B = 4/3 Closed center
- C = 4/3 Tandem center
- D = 4/3 Float center
- E = 4/2 Crossover offset
- F = 3/3 Tandem center
- G = 3/3 Closed center
- H = 2/2 Normally closed
- K = 2/2 Normally open
- M = 4/2 Float offset
- P = 3/2 Normally open

**2 Oil flow capacity**

- 1 = 920 in<sup>3</sup> per minute

**3 Solenoid voltage**

- 1 = 24 VDC, 50 / 60 Hz
- 2 = 230 V, 1 ph, 50 Hz
- 5 = 115 V, 1 ph, 60 Hz
- 6 = 230 V, 1 ph, 60 Hz

**4 Accessory valves**

- 000 = No accessory valves
- 100 = VS-11 Relief valve only
- 150 = VS-11 Relief valve and VS-51 3-way pilot operated check valve VEF/VEG only
- 160 = VS-11 Relief valve and VS-61 4-way pilot operated check valve VEA/VEB/VEC/VED only
- 500 = VS-51 3-way pilot operated check valve VEF/VEG only
- 600 = VS-61 4-way pilot operated check valve VEA/VEB/VEC/VED only

**5 Manifold**

- A = No manifold
- B = Remote mounted manifold
- D = Pump mounted manifold VEA/VEC/VEF only

**Example**

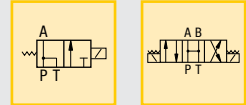
The **VEA-15600-D** is a modular valve with a 4-way, 3-position open center flowpath, 115 VAC, and an integrated pilot-operated check valve, for mounting on an Enerpac pump. Bolt Kit **BK-2** is included.

Pressure: 0-10,000 psi

Flow max.: 920 in<sup>3</sup>/min

Voltage: 24, 115, 230 V

- E** Válvulas de control
- F** Electro distributeurs
- D** Wegesitzventile



**Options**

Gauges and accessories

190 ▶



Fittings

194 ▶



**Accessory Valves and Bolt Kits**

Use **VS-11** relief valve to add system pressure control to VE-series valves.

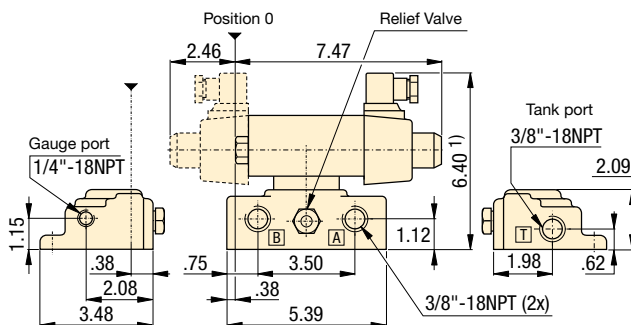
Use **VS-51** 3-way pilot operated check valve to convert 3-way VE-valve into load-holding valve.

Use **VS-61** 4-way pilot operated check valve to convert 4-way VE-valve into load-holding valve.

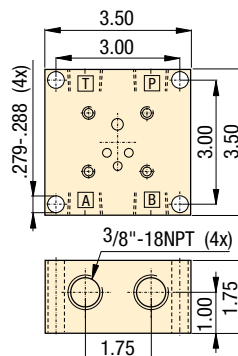
To install accessory valves to stack build modular valves use bolt kits:

- BK-2** for 1 VS valve;
- BK-3** for 2 VS valves.

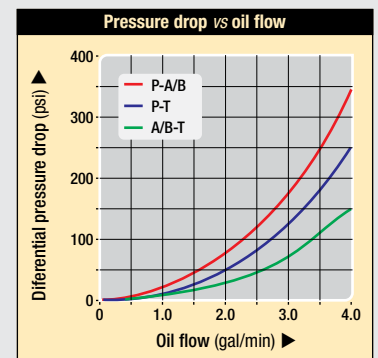
**VE series Modular Valve Pump Mounted**



**Modular Valve Remote Mounted**



<sup>1)</sup> add 1.85 inch for each Accessory Valve.  
Note: BK-1 Bolt Kit is included with each modular valve.



# 3-way directional manual control valves *Application & selection*

Shown: VM-2, VM-3



## V-series

Manual operated 3-way, 2-position and 3-way, 3-position directional control valves for operation of single-acting cylinders. Remote mount valves include return line kit for connecting the valves to pump reservoir.

### Application

Pump mounted valves provide centralized control of pump output for cylinder cycling. Remote mounted at any convenient point along the system where control of cylinders is needed.

## Reliable control of single-acting cylinders

- Directional control valves provide advance/hold/retract operation for use with single-acting cylinders
- Remote or pump mounting on most Enerpac pumps
- Return line kit included with remote valves
- Available “locking” option on VC and VM-series valves for load-holding applications

## Select the required center position

### Non-locking

- Use in simple clamping circuits. Has interflow between ports when shifted.

### Closed center

- For multiple valve and cylinder operation. All ports blocked in the center position.

### Locking center

- For positive load holding without loss of pressure. Cylinder travel can only resume by shifting valve from hold position.

### Tandem center

- For one or multiple cylinder operation. Pump flow is directed back to tank in the center position.

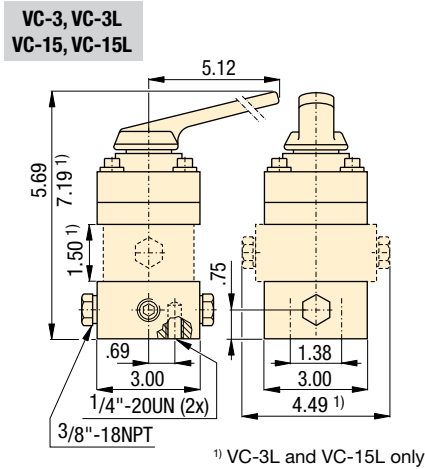
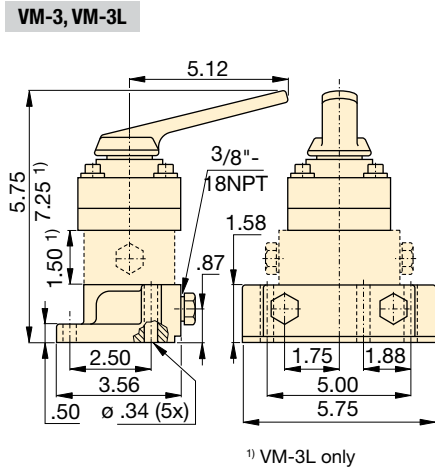
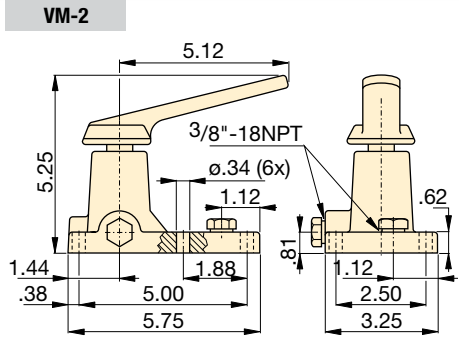
## Product selection

Valve type	Valve mounting location	Model number	Hydraulic symbol
<b>▼ Manual 3-way, 2-position (3/2)</b>			
–	Pump	VM-2	
<b>▼ Manual 3-way, 3-position (3/3)</b>			
Tandem center	Pump	VM-3	
Tandem center	Remote	VC-3	
<b>▼ Manual 3-way, 3-position (3/3)</b>			
Tandem center, locking	Pump	VM-3L	
Tandem center, locking	Remote	VC-3L	
Closed center	Remote	VC-15	
Closed center, locking	Remote	VC-15L	

■ Four VC-15 Enerpac manual valves mounted on fixture to give independent control of several hydraulic circuits.

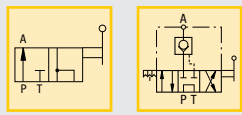


Collet-Lok® product line  
Swing clamps  
Work supports  
Linear clamps  
Power sources  
Valves



Pressure: 0-10,000 psi  
Flow max.: 1040 in<sup>3</sup>/min

- E** Válvulas de control
- F** Distributeurs à 3 voies
- D** 3-Wege-Ventile



**Product specifications**

Model number	Pressure range	Used for cylinder	Schematic flowpath			lbs
			Advance	Hold	Retract	
▼ Manual 3-way, 2-position (3/2)						
VM-2	0-10,000	Single-acting		-		4.8
▼ Manual 3-way, 3-position (3/3)						
VM-3	0-10,000	Single-acting				4.6
VC-3	0-10,000	Single-acting				6.4
▼ Manual 3-way, 3-position (3/3)						
VM-3L	0-10,000	Single-acting				8.6
VC-3L	0-10,000	Single-acting				10.3
VC-15	0-10,000	Single-acting				6.4
VC-15L	0-10,000	Single-acting				10.3

**Options**

- Gauges and accessories [190](#)
- Hoses and couplers [192](#)
- Fittings [194](#)

**Important**

**Locking Valves**  
For applications that require positive load holding, most VM and VC valves are available with pilot operated check valve. This option provides hydraulic locking of the load until valve is shifted into retract position. To order this feature, place an "L" at the end of the model number.

**Valving help**  
See Basic System Set-up and Valve information in our "Yellow Pages". [197](#)

Valves  
Pallet components  
System components  
Yellow pages

# 4-way directional manual control valves *Application & selection*

Shown: VC-20, VM-4



## V-series

Manual operated 4-way, 3-position directional control valves for operation of double-acting or two single-acting cylinders. Remote mount valves include return line kit for connecting the valves to pump reservoir.

### Application

Pump mounted valves provide centralized control of pump output for cylinder cycling. Remote mounted at any convenient point along the system where control of cylinders is needed.

## Reliable control of double-acting cylinders

- Directional control valves provide advance/hold/retract operation for use with double-acting or two single-acting cylinders
- Remote or pump mounting on most Enerpac pumps
- Return line kit included with remote valves
- Available “locking” option on VC and VM-series valves for load-holding applications

## Select the required center position

### Non-locking

- Use in simple clamping circuits. Has interflow between ports when shifted.

### Closed center

- For multiple valve and cylinder operation. All ports blocked in the center position.

### Locking center

- For positive load holding without loss of pressure. Cylinder travel can only resume by shifting valve from hold position.

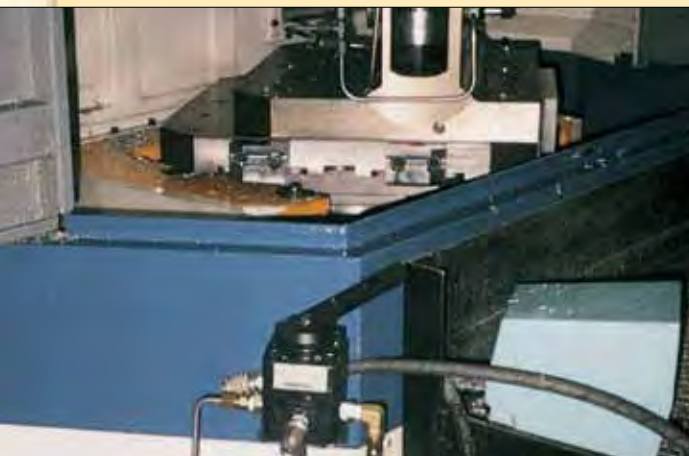
### Tandem center

- For one or multiple cylinder operation. Pump flow is directed back to tank in the center position.

## Product selection

Valve type	Valve mounting location	Model number	Hydraulic symbol
<b>▼ Manual 4-way, 3-position (4/3)</b>			
Tandem center	Pump	<b>VM-4</b>	
Tandem center	Remote	<b>VC-4</b>	
Tandem center, locking	Pump	<b>VM-4L</b>	
Tandem center, locking	Remote	<b>VC-4L</b>	
Closed center	Remote	<b>VC-20</b>	
Closed center, locking	Remote	<b>VC-20L</b>	

■ Enerpac VC-4 manual valves mounted to control hydraulic circuit on pallet fixture



Collet-LoK® product line  
Swing clamps  
Work supports  
Linear clamps  
Power sources  
Valves

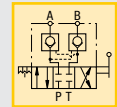
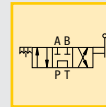
99-139

99-120

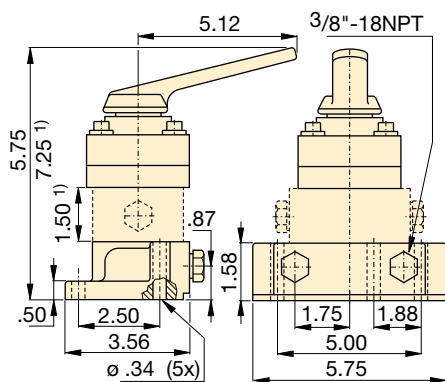
Pressure: 0-10,000 psi

Flow max.: 1040 in<sup>3</sup>/min

- E** Válvulas de control
- F** Distributeurs à 4 voies
- D** 4-Wege-Ventile

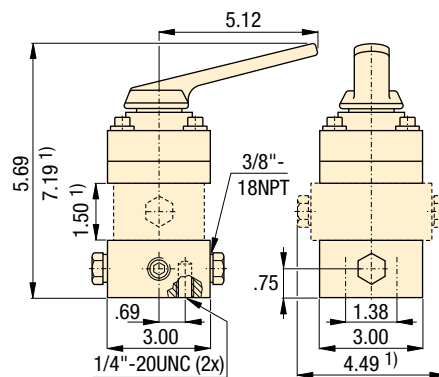


**VM-4, VM-4L**



<sup>1)</sup> VM-4L only

**VC-4, VC-3L  
VC-20, VC-20L**



<sup>1)</sup> VC-4L and VC-20L only

**Product specifications**

Model number	Pressure range	Used for cylinder	Schematic flowpath			lbs
			Advance	Hold	Retract	
<b>▼ Manual 4-way, 3-position (4/3)</b>						
VM-4	0-10,000	Double-acting				4.6
VC-4	0-10,000	Double-acting				6.4
VM-4L	0-10,000	Double-acting				8.6
VC-4L	0-10,000	Double-acting				10.3
VC-20	0-10,000	Double-acting				6.4
VC-20L	0-10,000	Double-acting				10.3


**Options**

**Gauges and accessories** 

☐ 190 ▶

**Hoses and couplers** 

☐ 192 ▶

**Fittings** 

☐ 194 ▶

**Important**

**Locking Valves**  
 For applications that require positive load holding, most VM and VC valves are available with pilot operated check valve. This option provides hydraulic locking of the load until valve is shifted into retract position.  
 To order this feature, place an "L" at the end of the model number.

**Valving help**  
 See Basic System Set-up and Valve information in our "Yellow Pages".

☐ 197 ▶

Shown: WVP-5, MVPM-5



## Sequence valves

Sequence valves block the oil to a secondary hydraulic circuit until pressure in the primary circuit reaches a preset level. The sequence valves have a built-in check system to allow the oil to flow back without external piping.

Pressure settings for the V-2000 can be adjusted by screwing the slotted pin in or out. The pressure settings for the other models is adjusted by loosening the jam nut and turn the set screw to reach your setting.

## Application

The sequence valves can be mounted in-line or fixture mounted using mounting bolts.

A typical application for the sequence valve would be to build pressure within work supports before the swing cylinders are applied to the supported part, to prevent deflection in the part.

■ Two WVP-5 sequence valves used in conjunction with Enerpac WCA-series Auto Coupler to provide system automation.



## Pressure dependent sequence control

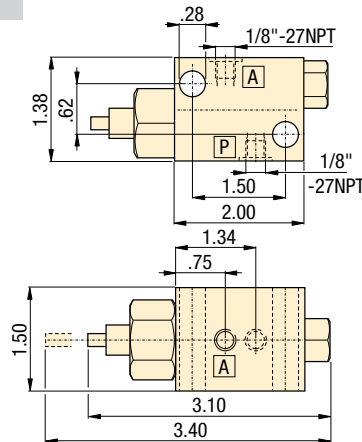
### MVPM-5, WVP-5, MVPC-5

- Direct accurate pressure setting
- Pressure setting between 500-5000 psi for secondary circuit is secured with lock nut
- Mounting holes on WVP-5, manifold mounting ports on MVPM-5
- MVPC-5 features cartridge body

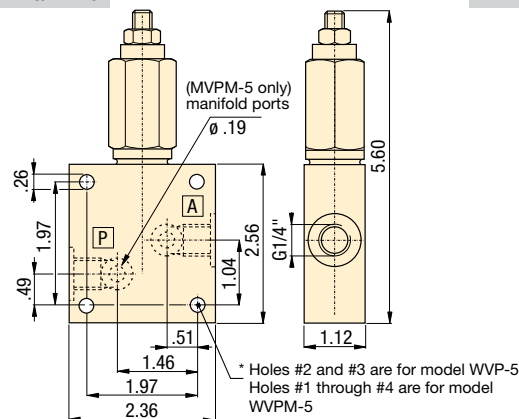
### V-2000

- Direct accurate pressure setting
- Pressure setting between 200-2000 psi for secondary circuit
- Flag indicator appears everytime the valve is operated

### V-2000



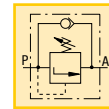
### MVPM-5/WVP-5



Pressure: 5000 psi

Flow: 250-366 in<sup>3</sup>/min max.

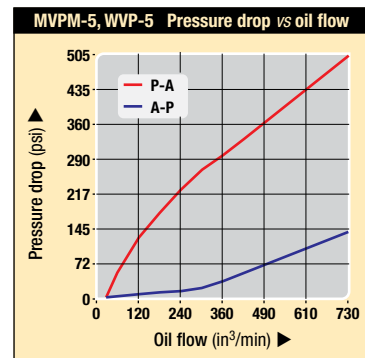
- Ⓔ Válvulas de secuencia
- Ⓕ Valve de séquence
- Ⓖ Folgeventil



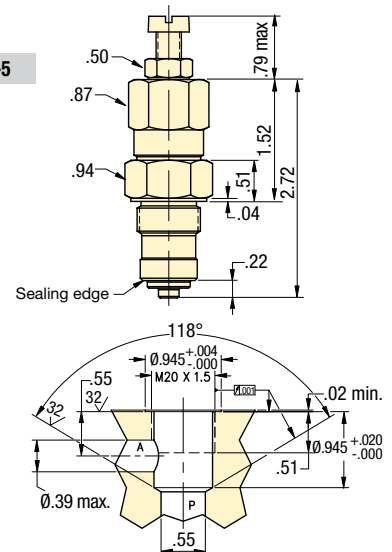
## Options

Gauges and accessories

□ 190



### MVPC-5



## Product selection

Pressure adjustment range	Maximum pressure	Maximum oil flow	Model number	Oil ports	Opening pressure	A	
psi	psi	in <sup>3</sup> /min			psi	in	lbs
200-2000	5000	250	V-2000	1/8"-27 NPT	—	—	2.0
500-5000	5000	620	MVPC-5	—	10	—	0.35
500-5000	5000	366	MVPM-5	G 1/4"	20	1.12	2.9
500-5000	5000	366	WVP-5	SAE #4	20	0.98	1.8

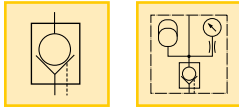
Seal material: Buna-N. Manifold O-rings included with MVPM-5. For manifold mounting installation information consult Enerpac for surface preparation.



Pilot ratio: 7:1

Flow: 10 gpm max.

- E** Válvulas antiretorno pilotada
- F** Clapets antiretour piloté
- D** Rückschlagventile



## To hold cylinder load and ensure remote unlocking

- Fast check-off response
- Hardened seats ensure long life and positive pressure holding
- Built-in accumulator to maintain system pressure
- Mounting holes
- Manifold mount body MVM-72

Shown: V-72

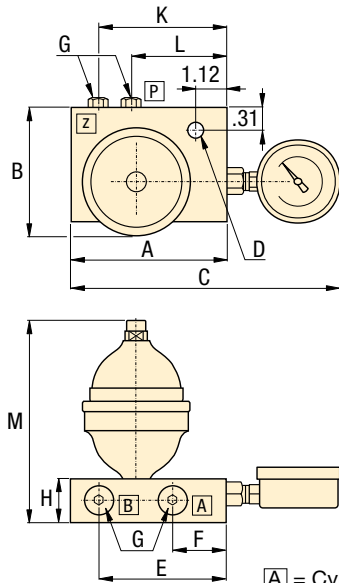


## Product selection

Pilot ratio	Accumulator included	Maximum oil flow	Maximum pressure	Model number	Oil ports	Optional charging tool for ACL	Weight
		GPM	psi				lbs
7:1	-	10	5000	<b>V-72</b>	SAE #4	-	4.0
7:1	ACL-22	10	5000	<b>MV-722B</b>	G 1/4"	WAT-2	6.0
7:1	ACL-202	10	5000	<b>MV-7202B</b>	G 1/4"	WAT-2	7.5
7:1	-	10	5000	<b>MVM-72</b>	G 1/4"	-	3.0

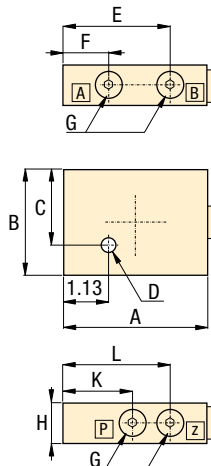
For more information on ACL-series Accumulators see page 124.

MV-722B, -7202B

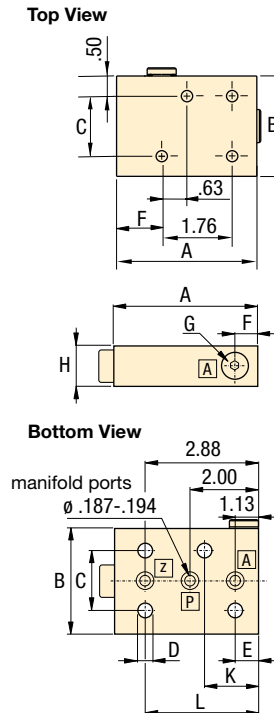


- A** = Cylinder advance
- B** = Cylinder retract
- P** = Pressure
- Z** = Pilot

V-72



MVM-72



## Product dimensions in inches [ $\pm 0.005$ ]

Model number	A	B	C	D	E	F	G	H	K	L	M
<b>V-72</b>	3.50	2.50	2.19	.28	2.88	1.13	SAE #4	1.25	2.00	2.88	-
<b>MV-722B</b>	3.50	2.80	7.25	.28	2.88	1.12	G 1/4"	1.25	2.88	2.00	5.71
<b>MV-7202B</b>	3.50	3.64	7.13	.28	2.88	1.12	G 1/4"	1.25	2.88	2.00	7.28
<b>MVM-72</b>	3.50	2.50	1.50	.28	1.13	1.12	G 1/4"	1.25	1.75	2.88	-

Seal material: Buna-N.

Manifold O-rings included with MVM-72. For manifold mounting installation information consult Enerpac for surface preparation.

[www.enerpacwh.com](http://www.enerpacwh.com)

## MV and V-series

Pilot operated check valves check the oil flow with a built-in pilot circuit providing fast, automatic check-off for your workholding applications.

The pilot operated check valves with built-in accumulator help to maintain system pressure due to minor oil loss.

## Application

Added capability to open with pilot pressure to allow cylinders to retract. By using a pilot operated check valve, cylinder retraction can be accomplished automatically without operator activity.

## Options

### Fittings



□ 194 ▶

Shown: PRV-3



## PRV series

These valves regulate system pressure for all subsequent valves, according to the adjusted pressure. Maintains a constant pressure in a secondary circuit. Includes a check valve that prevents pressure drop on secondary side.

### Application

Used when a hydraulic supply with a higher pressure (primary side) must also be used for another circuit with a lower pressure (secondary circuit).

The PRVM-2 manifold can be manifold mounted or plumbed with tubing. The PRV-8 and PRV-9 use this manifold to provide a pre-assembled valve. PRV-3 and 4 are for remote mounting. The cartridge from PRV-3 and 4 can be removed from manifold for direct integration into gundrilled fixture. Order the cartridge separately as PRV-3T or PRV-4T.

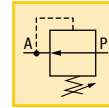
## Precise control of hydraulic pressure

- Tool adjustable knob can be locked
- Precise control of pressure
- G1/4" oil connection
- Remote mount
- PRVM-2 manifold has both 1/4" BSPP and manifold ports
  - Gauge port- 1/8" NPT

Pressure: 5000 psi

Flow: 427 in<sup>3</sup>/min

- (E) Válv. reguladora de presión
- (F) Valve de pression réglable
- (D) Druckreduzierventil



## Options

### Gauges

190 ▶

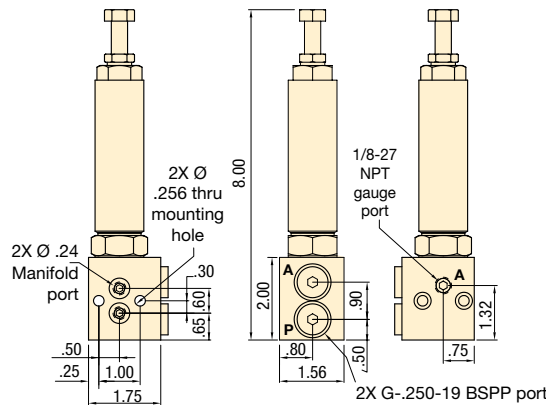


### Fittings

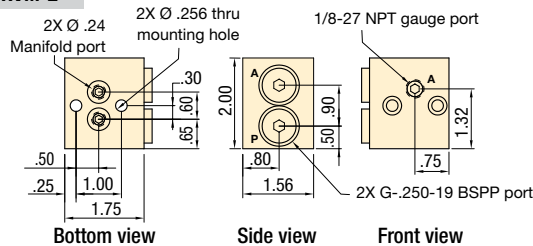
194 ▶



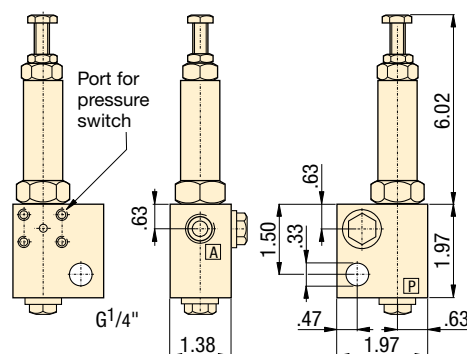
### PRV-8 & PRV-9



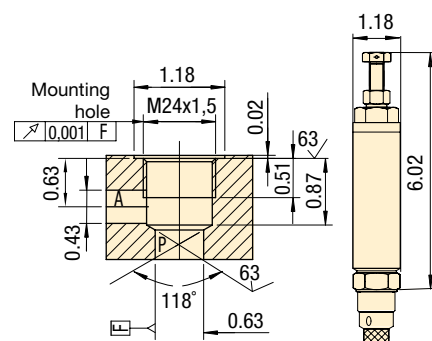
### PRVM-2



### PRV-3, -4



### PRV-3T, -4T



## Product selection

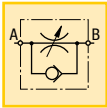
Mounting style	Adjustable pressure range	Maximum pressure	Model number	Oil ports	Maximum oil flow	🏠
	psi	psi		BSPP	in <sup>3</sup> /min	
Remote	435 - 4350	5000	PRV-3	G1/4"	427	2.9
Cartridge	435 - 4350	5000	PRV-3T	-	427	1.5
Remote	75 - 2000	5000	PRV-4	G1/4"	427	2.9
Cartridge	75 - 2000	5000	PRV-4T	-	427	1.5
Remote	435 - 4350	5000	PRV-8	G1/4"	427	2.4
Remote	72 - 2000	5000	PRV-9	G1/4"	427	2.4
Remote	-	5000	PRVM-2	G1/4"	427	1.3

Collet-Lok® product line  
Swing clamps  
Work supports  
Linear clamps  
Power sources  
Valves

Max. Flow: 10 gpm

Pressure: 0-5000 psi

- E** Válv. reguladoras de caudal
- F** Valves de control débit
- D** Stromregelventile



## Regulate the flow of oil

- Poppet valve design for zero leakage
- Color coded flow indicator
- Free flow return
- Fine metering capability
- Lockable
- Standard Viton seals

## Options

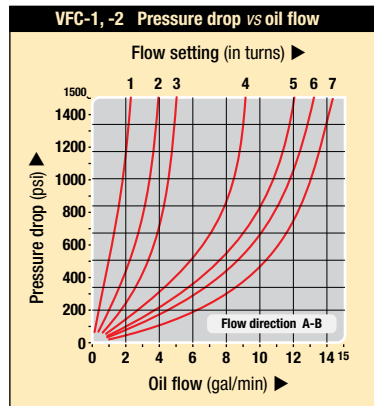
### Fittings

194 ▶

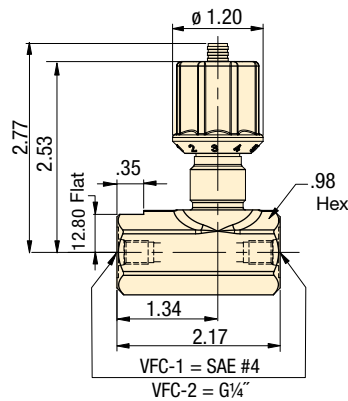


### High pressure filter

193 ▶



VFC-1, -2



## Product selection

Maximum oil flow	Pressure range	Oil ports	Model number	Flow path	Maximum pressure drop	
gpm	psi				psi	lbs
<b>▼ Flow control valves</b>						
10	0-5000	SAE #4	VFC-1		1500	1.8
10	0-5000	G 1/4"	VFC-2		1500	1.8

Seal material: Viton

Shown: VFC-1



## VFC-series

Provide repeatable oil flow control. The internal check valve allows metered flow in one direction and free flow in the opposite direction. Precise control is achieved with a micro-meter style adjustment knob, which can be locked with the set screw.

### Application

Use VFC-series flow control valves in-line with the Enerpac WE-series workholding pump to protect your components from damage due to high flow rates.

■ In-line installation of a VFC-1 flow control valve.



Shown: HV-1000A, V-17, V-10, V-12, V-152



## Accessory valves

Enerpac accessory valves are available in a wide variety and many configurations to control hydraulic pressure or oil flow. These valves are used in conjunction with other valves and system components to provide full automation and control.

### Application

Accessory valves are used to automate clamp cycles, prevent pressure loss and provide additional operator and component safety.

## Your hydraulic control solution

- Regulate oil flow or system pressure
- All valves feature NPT or SAE porting to insure against leakage at rated pressure
- Can easily be installed in any system
- All valves are painted, coated or plated for corrosion resistance

## Product selection

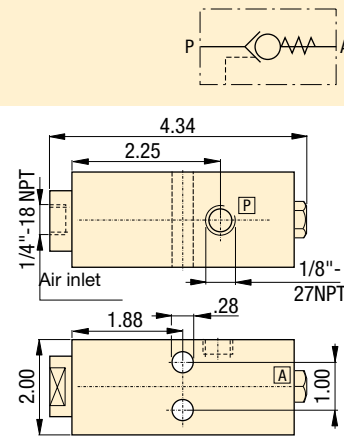
Valve type	Maximum pressure psi	Model number	Oil ports
Holding valve, air pilot	3000	<b>HV-1000A</b>	1/8" NPT
Holding valve, modular	3000	<b>MHV-1</b>	1/8" NPT
Pressure limiting valve	3000	<b>PLV-40013B</b>	1/8" NPT
Manual shut-off valve	5000	<b>V-12</b>	SAE #4
Auto-damper valve	10,000	<b>V-10</b>	1/2" NPT
Safety check valve	10,000	<b>V-17</b>	3/8" NPT
Pressure relief valve	10,000	<b>V-152</b>	3/8" NPT

## Product specification

### HV-1000A

#### Air pilot holding valve

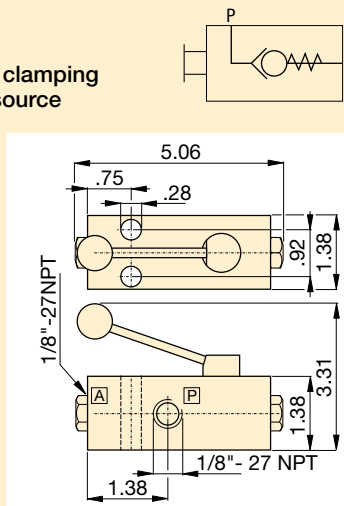
- Holds fluid under pressure offering independent control of different branches of the same fixture
- Valve can control the pilot air and the booster in sequence
- Max. oil flow 305 in<sup>3</sup>/min
- Works with the VA-42 four-way air valve and a booster



### MHV-1

#### Modular holding valve

- Allows separate operation of clamping fixtures with a single power source
- Ideal for applications when fluid feed lines are impractical. If system pressure is interrupted, the MHV-1 will hold the pressure beyond the valve
- Max. oil flow 305 in<sup>3</sup>/min
- To release system pressure, rotate valve handle in either direction 90° to release and retract system pressure



■ V-17 Safety check valve installed on a fixture.

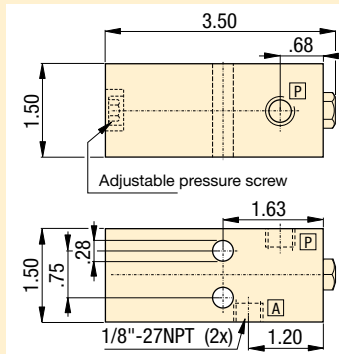
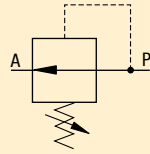


99-122b

**PLV-40013B**

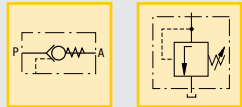
**Pressure limiting valve**

- Allows precise control of pressures reaching specific clamps
- When pressure build-up reaches a preset level, the valve closes, stabilizing pressure to that section of the fixture
- Pressure adjustment between 200 to 1500 psi
- Max. oil flow 305 in<sup>3</sup>/min



Pressure: 0-10,000 psi  
Flow max.: 305-1830 in<sup>3</sup>/min

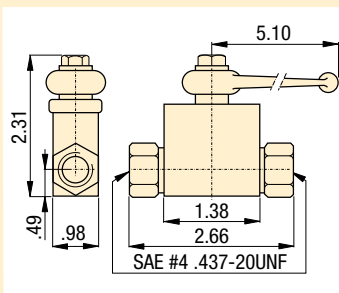
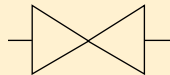
- E** Válvulas de control
- F** Valves de contrôle
- D** Regelventile



**V-12**

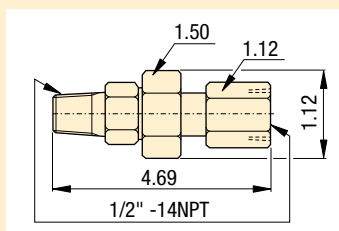
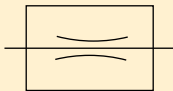
**Manual shut-off valve**

- Ball type valve can be used for the master system shut-off or for isolating separate circuits on a fixture
- Viton seals standard
- Straight through design for easy system plumbing and installation
- Fully open allows high flow return of oil
- Max. oil flow 732 in<sup>3</sup>/min




**V-10 Auto-damper valve**

- To protect gauge during high cycle applications
- Creates a flow resistance when load is released suddenly
- No adjustments are necessary
- Fits directly into GA-series gauge adaptor




**Options**

**VA-42 Air valve**  [158](#)

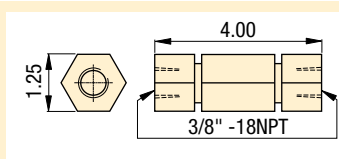
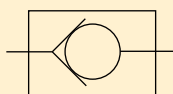
**Gauges and adaptors**  [190](#)

**Hoses and couplers**  [192](#)

**Fittings**  [194](#)

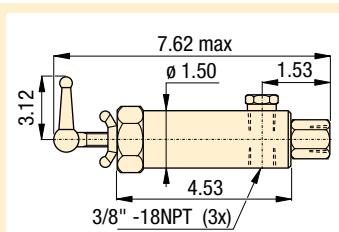
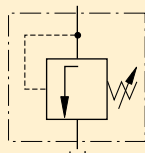
**V-17 Safety check valve**

- Ruggedly built to resist shock and operate with low pressure drop
- Closes smoothly without pounding
- Max. oil flow 1830 in<sup>3</sup>/min



**V-152 Pressure relief valve**

- Limits pressure developed by the pump in hydraulic circuit, thus limiting the force imposed on other components
- 800-10,000 psi adjustment range; ± 3% repeatability
- Valve opens whenever preset pressure is reached. To increase pressure setting, turn handle clockwise
- Max. oil flow 1830 in<sup>3</sup>/min
- Includes 3 ft. return line hose kit



**Important**

**Valving help**  
See Basic System Set-up and Valve information in our "Yellow Pages". [197](#)

Shown: VA-42, VAS-42



## Air valves

Enerpac's line of directional air valves and accessories complete your workholding system. Used to control air operated hydraulic units, they increase your productivity and efficiency.

### Application

VA-series directional air valves provide either manual or electric control to air operated hydraulic units. Accessories such as rapid exhaust, check valves, silencers and regulators complete the air control system.

- Accessory valves provide greater safety and more efficient clamping cycles
- Recommended for use with all air powered units
- Directional valves to control booster and pump air supply
- Remote air valve permits either hand or foot operation

## To control and regulate air supply

### VA-42 Manual operated air valve 5-way, 2-position

- For control of boosters
- Viton seals standard

### VAS-42 Solenoid operated air valve 5-way, 2-position

- For control of pump and boosters air supply
- Viton seals standard
- Solenoid: 120 VAC, 50/60Hz  
Amperage: inrush .11 Amps, holding .07 Amps
- Maximum cycle rate: 600 cycles per minute

### VR-3 Rapid exhaust valve

- Enables booster to advance and retract faster
- Instantly exhausts air supply from booster to atmosphere

### V-19 Air check valve

- Prevent rapid drop of air pressure to the booster in the event of sudden loss of input air

### RFL-102 Regulator-Filter-Lubricator

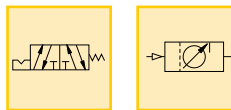
- Regulates air pressure
- Filter air input
- Lubricates air motors with a fine oil vapor mist
- Maximum air flow 48 scfm

### QE-375 Muffler

- Use with VR-3 or VAS/VA-42
- Reduces noise level of exhaust air from pump

Air Pressure: 0-150 psi

- (E) Válvulas de aire
- (F) Valves à air
- (D) Luftventile



## Options

### Gauges and adaptors

□ 190 ▶



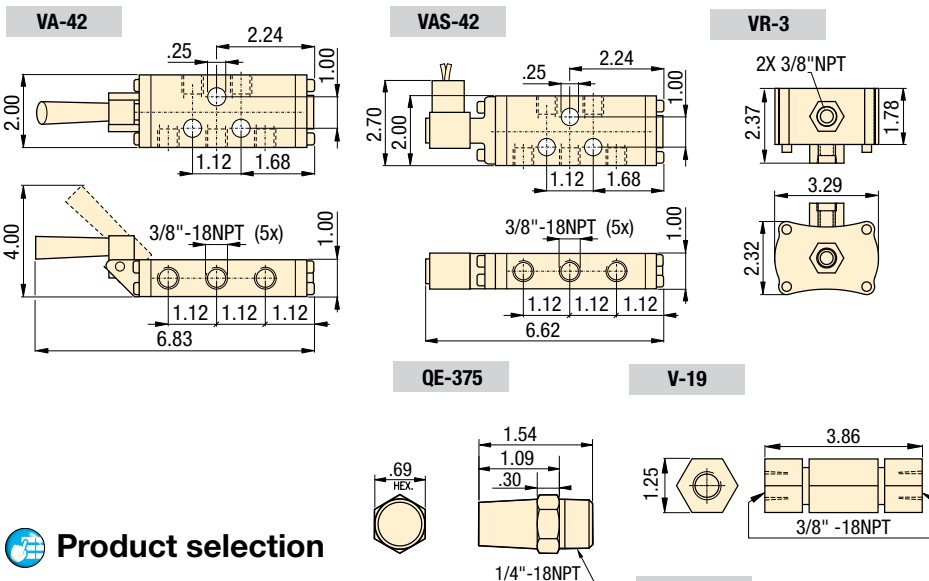
### Hoses and couplers

□ 192 ▶



### Fittings

□ 194 ▶



## Product selection

Maximum pressure psi	Model number
▼ Air valves	
30-150	VA-42
30-150	VAS-42
0-100	VR-3
0-100	V-19
▼ Accessories	
0-125	RFL-102
0-125	QE-375

## Important

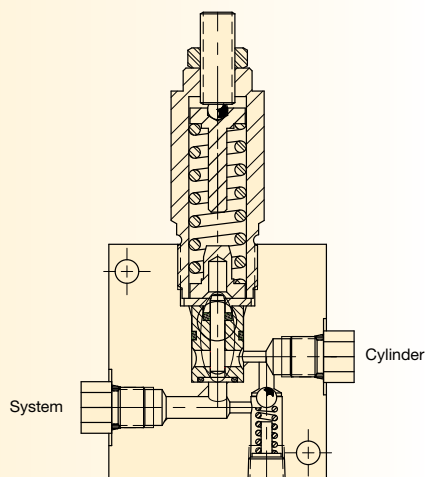
**Valving help**  
See Basic System Set-up and Valve information in our "Yellow Pages".

□ 223 ▶

## Valve Cutaways

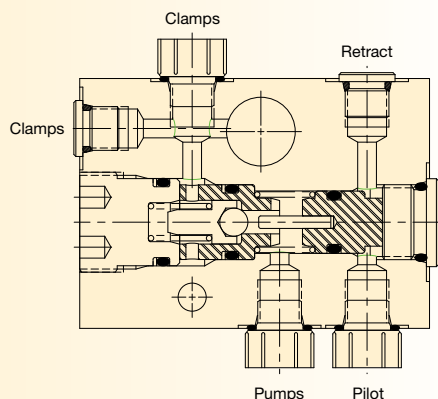
### WVP-5

The opening point is set by the adjustment spring. Incoming pressure is blocked by the valve spindle in the orifice plate. When opening pressure is reached, the spindle is pushed up until fluid will pass. The system pressure level is maintained as pressure builds in the downstream circuit. Reverse flow is through a reverse check valve.



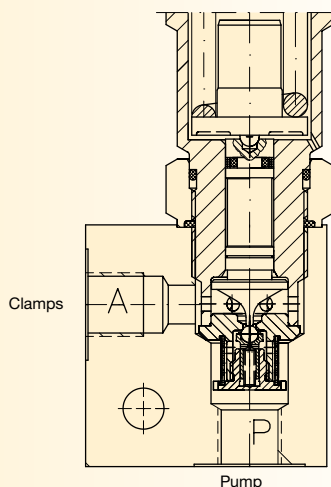
### V-72

System pressure enters through the "Pump" port, flows through the check seat and past the check valve into the cylinder circuit. When system pressure drops, the check ball closes off the seat, blocking flow. To release the cylinder pressure, the "Pilot" port is pressurized, and the pilot piston pushes the check ball off of the seat, allowing reverse flow.



### PRV-3

A check ball is held off of the check seat by a spring loaded spindle. The spring setting determines the closing point of the valve. As pressure builds in the cylinder side of the circuit, the spindle is lifted, and the check seats. Closing off further flow through the valve provides a reduced pressure to the cylinder.



# Palletized fixture

Enerpac provides a variety of solutions for use in palletized fixtures:

- Manual and Automated Coupler Systems for connecting/disconnecting to the fixture
- Rotary couplers for use with continuous connection systems
- Pressure intensifiers to provide increased pressure for clamping when used with machine hydraulics
- Safe Link for remote wireless monitoring of fixture pressure or clamp position











## Technical support

- Safety instructions
- Basic hydraulic information
- Advanced hydraulic technology
- FMS (Flexible Machining Systems) technology
- Conversion charts and hydraulic symbols



# components

	▼ series	▼ page	
Accumulators	AC WA	162 - 163	
Coupler Packages	AC, AP MHV	164 - 165	
Manual couplers	MCR MCH	166 - 171	
Activator wand & boosters	B, RA	172 - 173	
Auto-coupler systems	WCA, WPA ACCB	174 - 175	
Rotary couplers	AMP, CR CRV	176 - 177	
Pressure intensifiers	PID	178 - 179	
SafeLink	SL	180 - 185	

Shown: ACL-201A, WA-502, ACL-21A

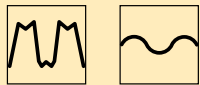


▶ Enerpac accumulators supply auxiliary pressure to dampen shock loads or to compensate pressure drop in applications where system pressure needs to be maintained.

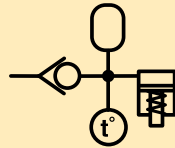
### Accumulator applications:

- Energy storage
- Circuit pulsation dampening
- Thermal expansion compensation

Pulse dampening



Thermal expansion



■ ACBS-202 Accumulator package used to maintain pressure on a machine tool fixture



## Accumulators

...maintain circuit pressure

- Ideal for high frequency and rapid discharge applications
- ACL series are pre-charged to 1450 psi
- Corrosion resistant bodies on ACL series
- Spring actuated accumulator for ACM-1
- High energy storage capacity in a compact package
- WA accumulators are piston type
- ACL accumulators are diaphragm type
- ACM accumulators use internal spring

## Product selection

Operating pressure	Model number	Max. rated oil volume	Gas volume	Pre-charged nitrogen pressure	Usable oil capacity
psi		in <sup>3</sup>	in <sup>3</sup>	psi	in <sup>3</sup> at 5000 psi
<b>▼ Pre-charged accumulators</b>					
0-3000	<b>ACM-1</b>	.10	-	-	-
1500-5000	<b>ACL-21A</b>	.90	1.22	1450	.53
1500-5000	<b>ACL-201A</b>	7.70	10.37	1450	4.51
1500-5000	<b>ACL-502A</b>	20.60	27.46	1450	12.0
<b>▼ Uncharged accumulators</b>					
0-5000 <sup>1)</sup>	<b>WA-502</b>	2.50	2.50	-	2.50
0-5000 <sup>1)</sup>	<b>WA-5010</b>	10.00	10.00	-	7.50

<sup>1)</sup> See pre-charge chart on page 163 for hydraulic operating pressures.

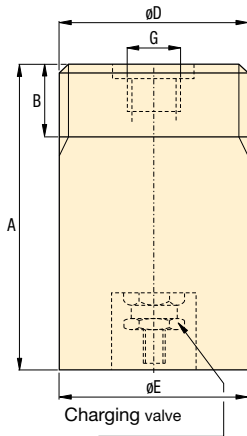
Collet-Lok® product line  
 Swing clamps  
 Work supports  
 Linear Clamps  
 Power sources  
 Valves  
 Pallet Components

**Recommended pre-charge**

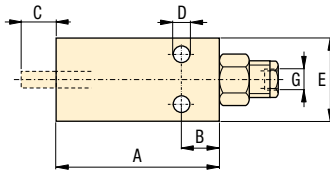
Operating pressure psi	Model number	Nitrogen pressure psi	Usable oil capacity <sup>1)</sup> in <sup>3</sup>
0-1000	<b>WA-502</b>	500	1.50
1000-3000	<b>WA-502</b>	1000	2.00
3000-5000	<b>WA-502</b>	1200	2.50
0-1000	<b>WA-5010</b>	500	5.50
1000-3000	<b>WA-5010</b>	1000	6.50
3000-5000	<b>WA-5010</b>	1200	7.50

<sup>1)</sup> At maximum operating pressure.

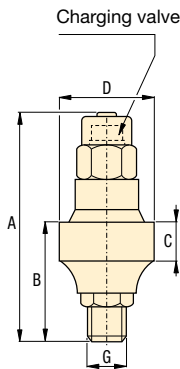
**WA**



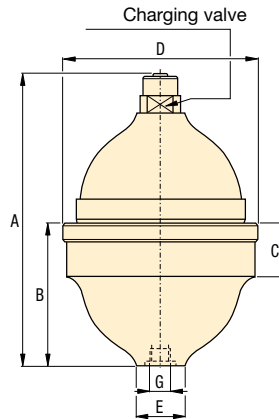
**ACM-1**



**ACL-21A**



**ACL-201A, 502A**



**Product dimensions in inches [  $\pm \frac{\square}{\square}$  ]**

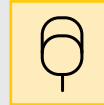
Model number	A	B	C	D	E	F	G	Recommended charging tool	lbs
<b>▼ Pre-charged accumulators</b>									
<b>ACM-1</b>	5.25	.75	.50	.265	1.75	-	.125-27 NPT	-	2.1
<b>ACL-21A</b>	4.14	1.46	.71	1.69	-	-	SAE #4	WAT-2	1.0
<b>ACL-201A</b>	5.39	2.72	1.14	3.33	1.14	-	SAE #6	WAT-2	2.7
<b>ACL-502A</b>	6.73	3.50	1.38	4.49	1.57	-	G3/8"	WAT-2	6.2
<b>▼ Uncharged accumulators</b>									
<b>WA-502</b>	4.69	1.19	-	2.750-16 UN	2.75	-	SAE #8	WAT-1	7.0
<b>WA-5010</b>	7.13	1.19	-	2.750-16 UN	2.75	-	SAE #8	WAT-1	11.5

Pressure: 0-5000 psi

Oil volume: .10-20.60 in<sup>3</sup>

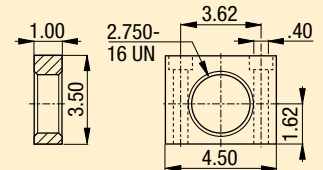
Gas volume: 1.22-27.46 in<sup>3</sup>

- E** Acumuladores
- F** Accumulateurs
- D** Druckspeicher



**Options**

**AW-50 Mounting block**  
For WA series accumulators.



**Hydraulic oil**

193 ▶



**Fittings**

194 ▶



Shown: AP-500, MHV-1, ACBS-22A



**▶ Accumulator packages will help maintain system pressure to your fixture when separated from the hydraulic source. The gauge will display system pressure after the circuit is disconnected.**

## Coupler packages

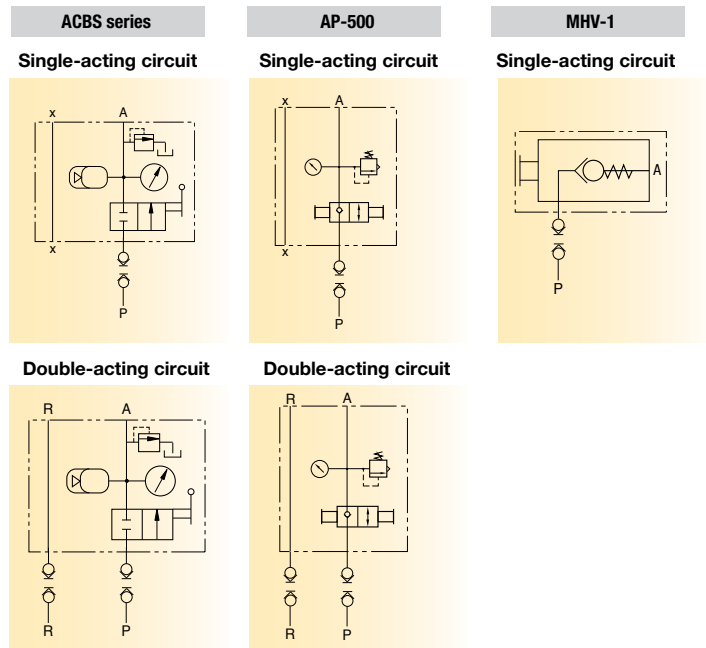
...compact design for easy use of accumulators

- Single design accommodates both single-acting or double-acting circuit
- Relief valve fitted and ball check shut-off
- Glycerin-filled gauge included
- Supplied standard with one male coupler (AH-652)
- Optional manifold mounting. O-ring seals located on bottom of block only for single-acting circuit

### MHV-1 Modular holding valve

- Allows separate operation of clamping fixtures with a single power source
- Ideal for applications when fluid feed lines are impractical. If system pressure is interrupted, the MHV-1 will hold the pressure beyond the valve
- Max. oil flow 305 in<sup>3</sup>/min
- To release system pressure, rotate valve handle in either direction 90° to release and retract system pressure

## **i** Coupler package circuits



■ ACBS-202 Accumulator package used to maintain pressure on a machine tool fixture



## **i** Product selection

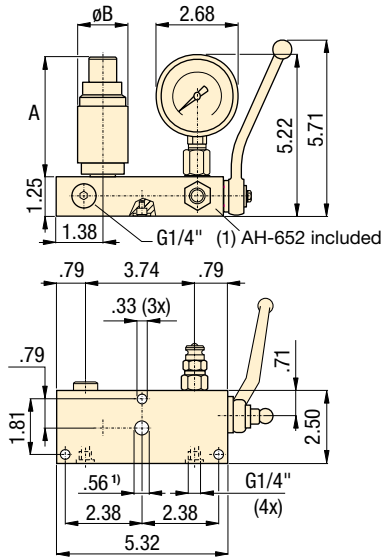
Operating pressure	Model number	Max. rated oil volume	Gas volume	Pre-charged nitrogen pressure	Usable oil capacity
psi		in <sup>3</sup>	in <sup>3</sup>	psi	in <sup>3</sup> at 5000 psi

### ▼ Accumulator coupler packages

1500-5000	<b>ACBS-22A</b>	0.90	1.22	1450	.53
1500-5000	<b>ACBS-202A</b>	7.70	10.37	1450	4.51
0-5000	<b>AP-500</b>	<b>AP-500 uses WA-502 or WA-5010<sup>1)</sup></b>			
0-3000	<b>MHV-1</b>	-	-	-	-

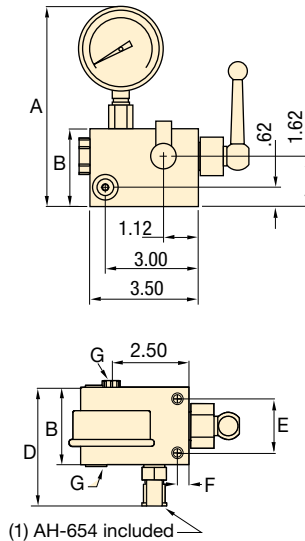
<sup>1)</sup> See pre-charge chart on page 163 for hydraulic operating pressures.

**ACBS**

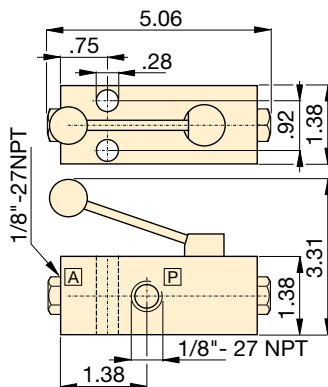


<sup>1)</sup> Manifold hole should not exceed Ø .30 inch when port is utilized.

**AP-500**



**MHV-1**

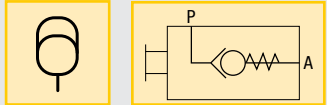


**Product dimensions** in inches [ ]

Model number	A	B	C	D	E	F	G	Recommended charging tool	lbs
<b>▼ Pre-charged accumulator coupler packages</b>									
<b>ACBS-22A</b>	2.69	1.65	-	-	-	-	G1/4"	WAT-2	10.1
<b>ACBS-202A</b>	4.18	3.33	-	-	-	-	G1/4"	WAT-2	11.8
<b>AP-500</b>	6.44	2.50	3.50	3.84	1.75	0.38	SAE #4	-	11.8
<b>MHV-1</b>	-	-	-	-	-	-	1/8" NPT	-	-

- Pressure: 0-5000 psi
- Oil volume: .10-7.70 in<sup>3</sup>
- Gas volume: 1.22-10.37 in<sup>3</sup>

- E** Acopladores manuales
- F** Manuel coupleur
- D** Manuelle kupplung



MHV-1

**Options**

**Couplers** □ 192 ▶

**High pressure filters** □ 193 ▶

**Hydraulic oil** □ 193 ▶

**Fittings** □ 194 ▶

**Important**

**Enerpac high pressure in-line filters are required for use with these control units to prevent damage that can be caused by contaminants that have penetrated your hydraulic fluid system.**

**Order an additional male coupler for use in double-acting hydraulic circuits.**  
**ACBS-Series: AH-652**  
**AP-500: AH-654**

Pallet components  
System components  
Yellow pages

Shown: MCH-31, MCRA-11, MCRC-21, MCH-21, MCR-21



▶ The Enerpac manual coupler is available as a dual connection model or dual connection with optional air circuit for part present sensing. The fixture side receiver is available with or without an internal pilot operated check valve. Filtration provides protection from contamination.

### Manual coupler applications:

- **With P.O. check**
  - Use MCRC-21 for a complete, unitized coupler receiver solution
- **Without P.O. check:**
  - Use MCR-21 when using a remote mounted Pilot Operated Check Valve

■ Enerpac manual couplers simplify the process of connecting and disconnecting to a palletized fixture.

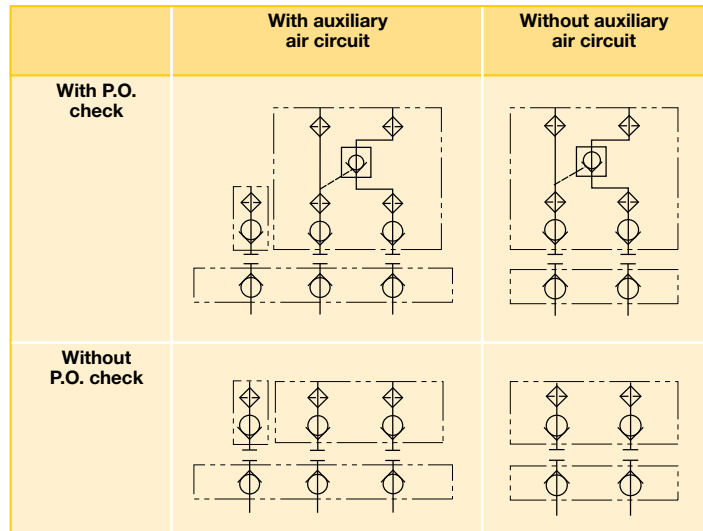


## Manual Couplers

...convenient connection

- Use on palletized fixtures
- Available with or without an internal pilot operated (P.O.) check valve
- Optional coupler block available to add circuit for air part present sensing
- Manifold porting
- Porting for tubing connections
- Filtration to prevent contamination
- Removable front plate provides access to the front filters and check cartridge
- Top port accommodates an accumulator or gauge

## Manual Coupler Circuits



Model number	Basic configurations	Circuits
MCRC-21	Pallet receiver with P.O. check	Two Hydraulic
MCR-21	Pallet receiver without P.O. check	Two Hydraulic
MCRA-11	Auxiliary air circuit receiver block	One Air
MCH-21	Operator handle	Two Hydraulic
MCH-31	Operator handle	Two Hydraulic, One Air
MCSB-21	Storage block	N/A
MCPS-21	Proximity switch kit	N/A

## Select your components

### MCRC-21 Pallet Receiver with P.O. Check

An internal pilot operated check valve and multiple ports to accommodate a gauge or accumulator make the MCRC-21 a great choice of coupler receiver for use in a palletized fixture. Internal filtration protects the check from contamination. Use with the MCH-21 operator handle.



### MCR-21 Pallet Receiver

For applications where the pilot operated check valve is remote mounted in the fixture circuit, use the MCR-1. Internal filtration protects the circuit from outside contamination.



### MCRA-11 Auxiliary air circuit receiver

The MCRA-11 is used to provide an additional connection for use with air part sensing circuits. Use with either the MCRC-21 or the MCR-21. Use with the MCH-31 operator handle.



### MCSB-21 Operator Handle Storage Block

Proper storage of the MCH-21 or MCH-31 handle prevents contamination of the couplers, and makes sure that the handle is disconnected from the fixture. Use the MCPS-21 proximity switch to confirm proper storage as an input to the machine control.



### MCH-21 Two Coupler Operator Handle

Use the MCH-21 with either the MCRC-21 or the MCR-21 pallet receiver.



### MCH-31

Use the MCH-31 when using the MCRA-11 with either the MCRC-21 or MCR-21 receivers.



Max. Flow: 4 GPM

Pressure: 0-5000 psi

- E Acopladores manuales
- F Manuel coupleur
- D Manuelle kupplung

## Options

### FZ Series fittings

 194 ▶



### Hoses and couplers

 192 ▶



### Pilot operated check valves

 153 ▶



### Accumulators

 162 ▶



## Important

Do not couple or uncouple with the hydraulic nozzles under pressure. This can damage the couplers.

Do not exceed maximum flow and pressure.

	Operating pressure psi	Replacement hydraulic nozzle	Replacement filter kit	Voltage	Model number
	100 - 5000	<b>AH654</b>	<b>F12201K</b>	-	MCRC-21
	100 - 5000	<b>AH654</b>	<b>F12201K</b>	-	MCR-21
	10 - 100*	<b>AH654</b>	<b>F12201K</b>	-	MCRA-11
	100 - 5000	<b>AR650</b>	-	-	MCH-21
	100 - 5000	<b>AR650</b>	-	-	MCH-31
	-	<b>AH654</b>	-	-	MCSB-21
	-	-	-	24 VDC	MCPS-21

\* Air pressure

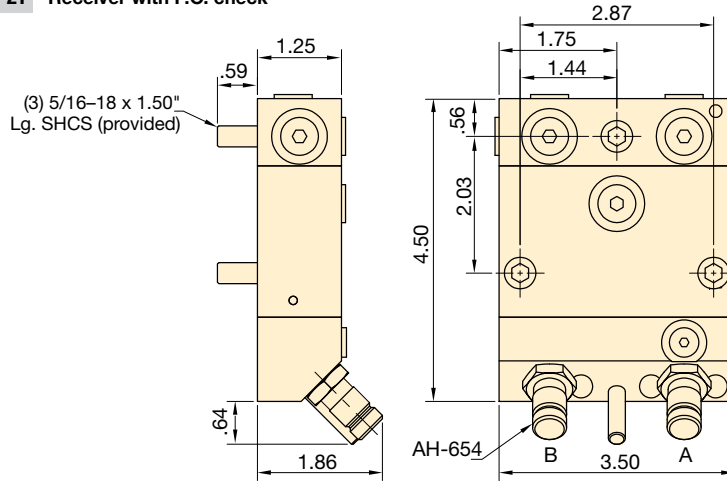
Shown: MCH-21, MCR-21



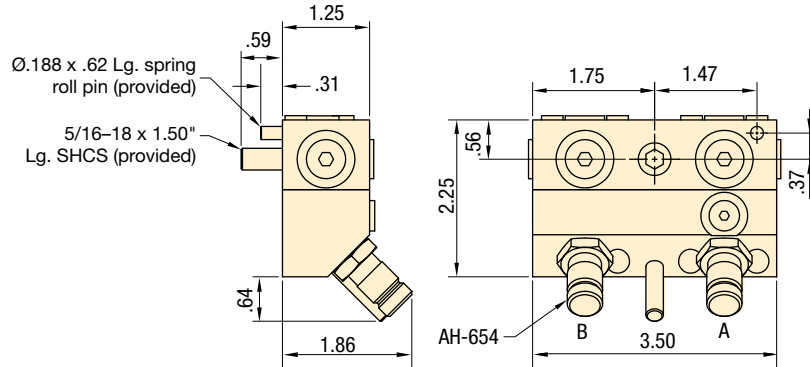
## ► Serie MCR e MCH

The Enerpac MCH-21 two passage operator handle conveniently connects and disconnects to the MCR-21 two passage receiver utilizing a simple push-on, pull-off action.

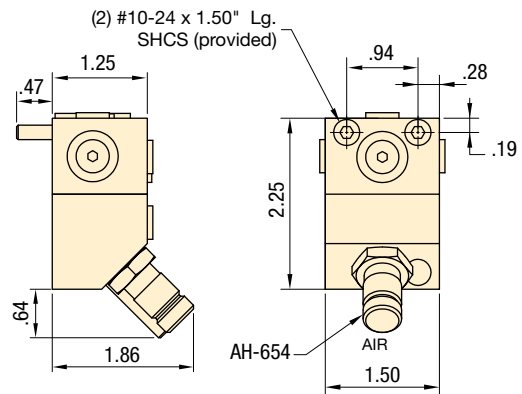
### MCR-21 Receiver with P.O. check



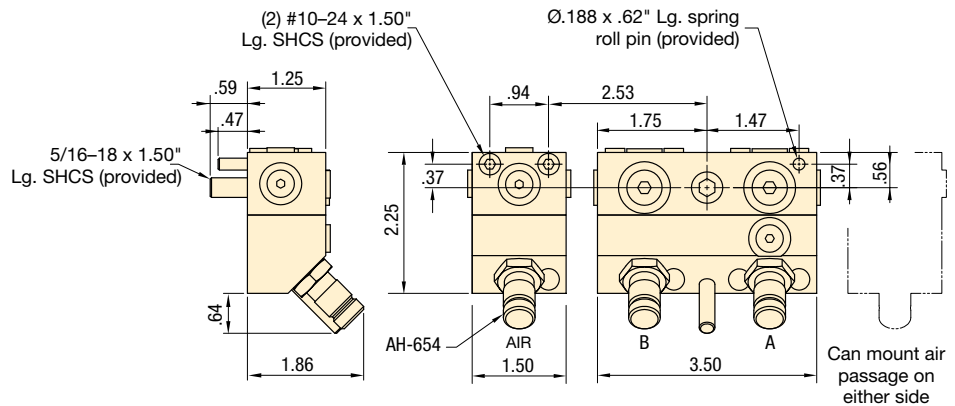
### MCR-21 Receiver without P.O. check



### MCRA-11 Auxiliary air circuit receiver



### MCR-21 with MCRA-11 Receiver with air passage and without P.O. check



Collet-Lok®  
product line

Swing clamps

Work supports

Linear Clamps

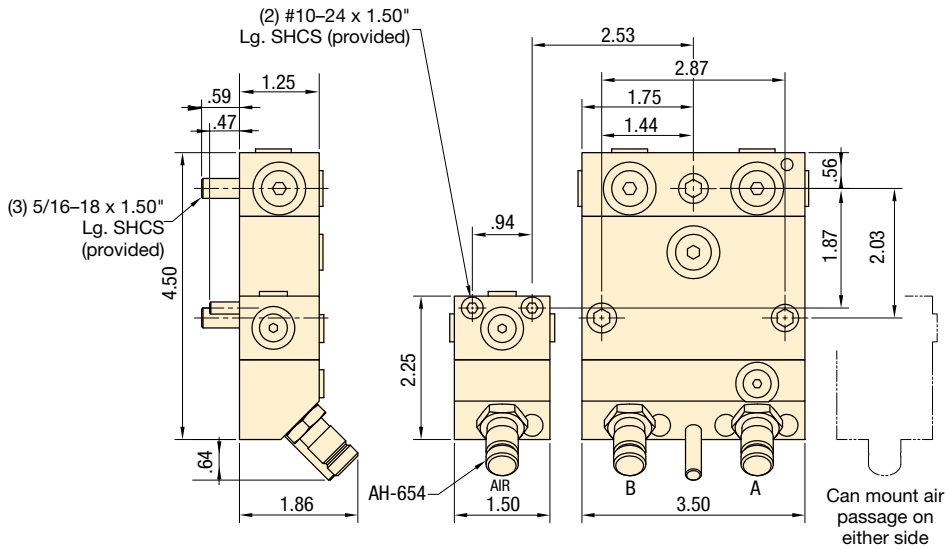
Power sources

Valves

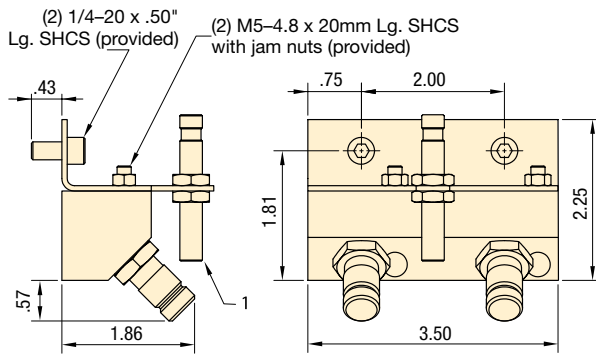
Pallet Components



**MCRC-21 with MCRA-11**

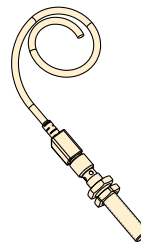


**MCSB-21 Storage block**

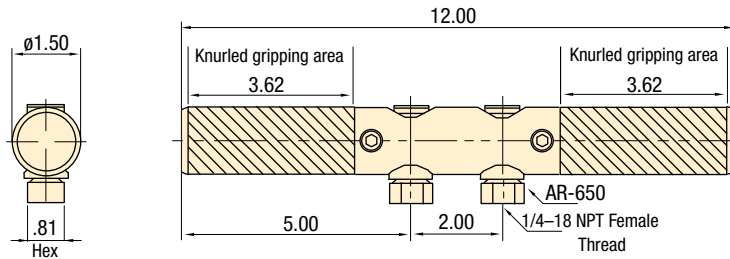


① Optional proximity switch is available. See MCPS-21

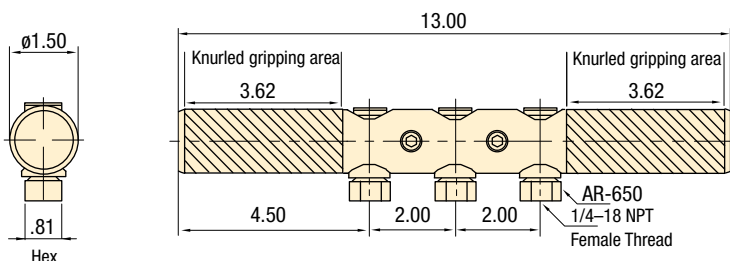
**MCPS-21 Optional proximity switch**



**MCH-21 Operator handle**



**MCH-31 Operator handle**



Max. Flow: 4 GPM

Pressure: 0-5000 psi

- E** Acopladores manuales
- F** Manuel coupleur
- D** Manuelle kupplung

**Options**

**FZ Series fittings**

▣ 194 ▶



**Hoses and couplers**

▣ 192 ▶



**Pilot operated check valves**

▣ 153 ▶



**Accumulators**

▣ 162 ▶



**Important**

Do not couple or uncouple with the hydraulic nozzles under pressure. This can damage the couplers.

Do not exceed maximum flow and pressure.

# Manual Couplers *Mounting patterns*

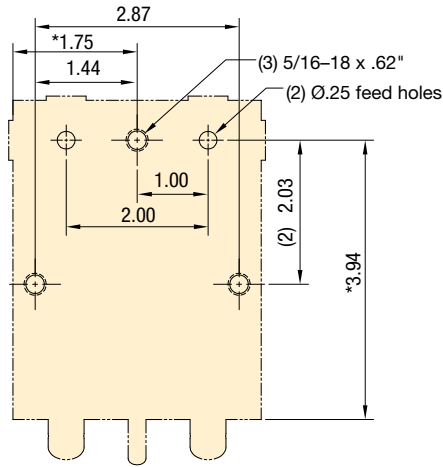
Shown: MCR-21



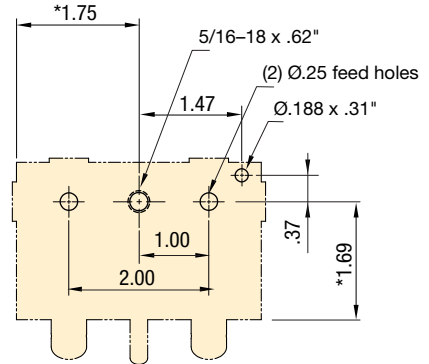
## **MCR series**

The MCR-21 two passage receiver features multiple SAE #4 ports as well as manifold mount ports for easy plumbing to a fixture. Internal filtration in all receiver models protects the circuit from external contamination.

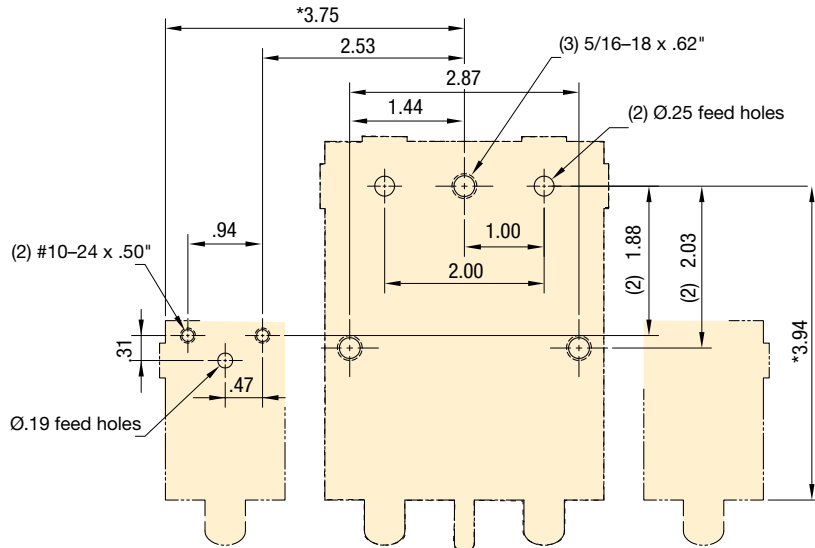
**MCR-21** Receiver with P.O. check – Mtg. hole pattern



**MCR-21** Receiver without P.O. check – Mtg. hole pattern

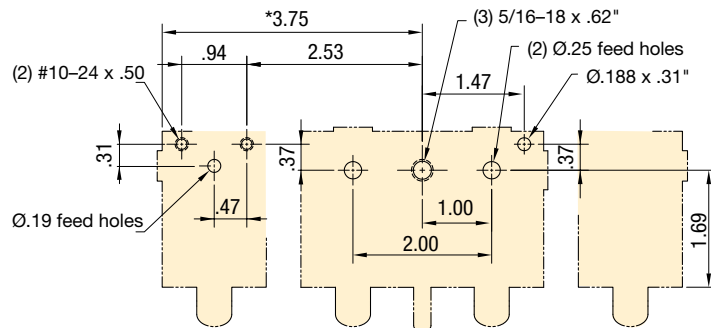


**MCRC-21 with MCRA-11** Receiver with air passage and with P.O. check – Mtg. hole pattern



Can mount air passage on either side.

**MCR-21 with MCRA-11** Receiver with air passage and without P.O. check – Mtg. hole pattern

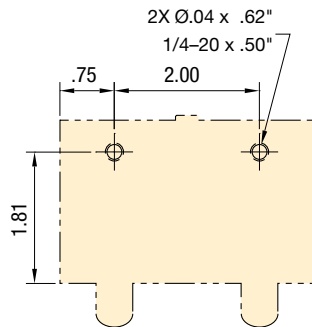


Can mount air passage on either side.

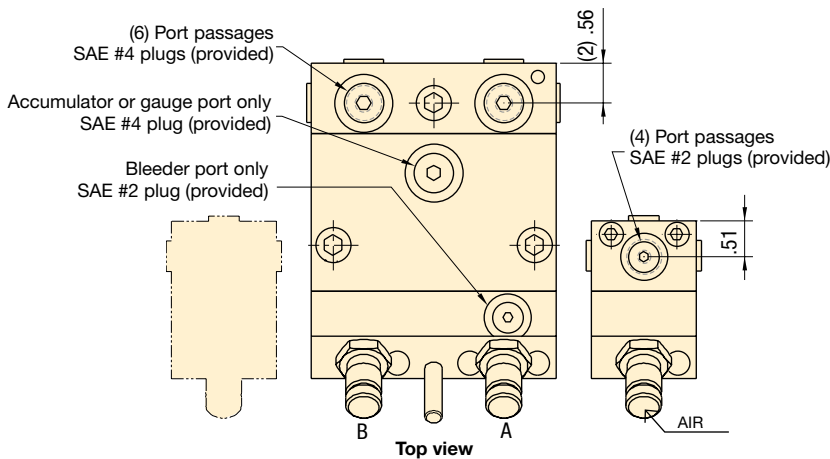
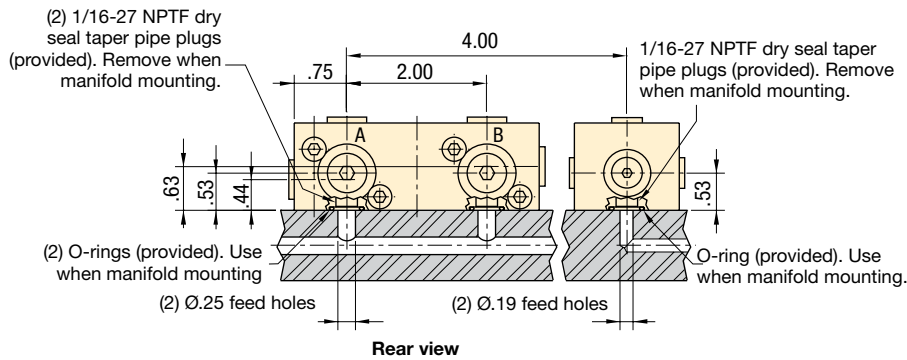
\* Minimum from edge of tool plate

Collet-Lok® product line  
Swing clamps  
Work supports  
Linear Clamps  
Power sources  
Valves  
Pallet Components

**MCSB-21** Storage Block – Mounting Hole Pattern



**Manifold and Port Dimensions**



**Max. Flow: 4 GPM**

**Pressure: 0-5000 psi**

- E** Acopladores manuales
- F** Manuel coupleur
- D** Manuelle kupplung

**Options**

**FZ Series fittings**

194 ▶

**Hoses and couplers**

192 ▶

**Pilot operated check valves**

153 ▶

**Accumulators**

162 ▶

**Important**

**Do not couple or uncouple with the hydraulic nozzles under pressure. This can damage the couplers.**

**Do not exceed maximum flow and pressure.**

# Activator wand and booster

Shown: RA-1061, B-81



## B and RA series

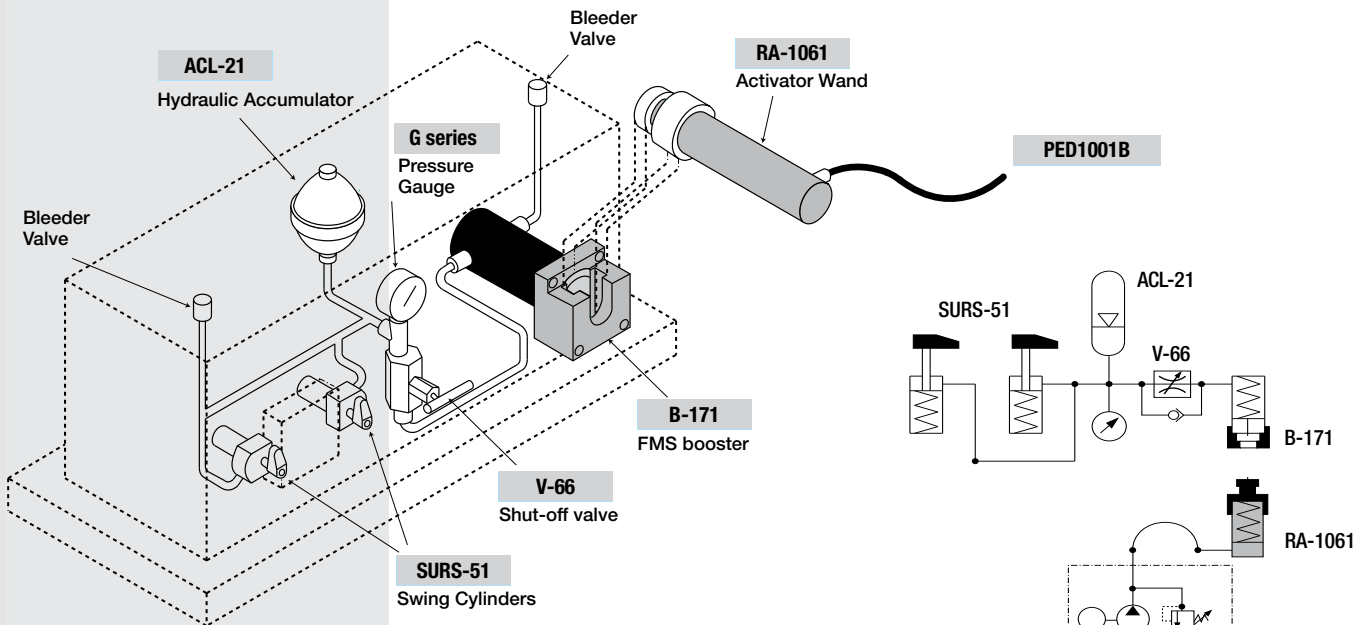
Mechanical energy transfer system uses external cylinder to operate receiver booster.

## Contamination resistant closed hydraulic system

- No-leak palletized system, eliminates oil loss at connection point
- Closed design prevents machining chips and coolant from entering the hydraulic circuit
- Booster can be mounted in either horizontal or vertical position for flexible fixture design

## Hydraulic system schematics

The Activator Wand RA-1061 is placed into the receiver booster B-81 or B-171. The mechanical transfer of force from the activator wand plunger to the booster piston provides oil flow to the system.



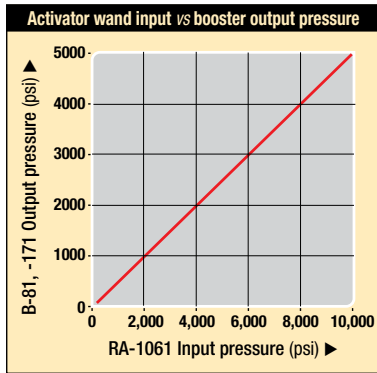
A manually placed Wand and Booster system is used to clamp the castings in this machining fixture.



## Product selection

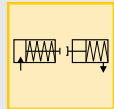
Pressure ratio	Oil flow ratio	Oil volume per stroke	Stroke	Model number	Effective area	Operating pressure	
		in <sup>3</sup>	in		in <sup>2</sup>	psi	lbs
<b>▼ Receiver booster</b>							
2:1	1.75:1	8.10	2.04	<b>B-81</b>	3.98	400-5000	12.7
2:1	1.75:1	17.10	4.30	<b>B-171</b>	3.98	400-5000	15.7
<b>▼ Activator wand</b>							
-	-	9.90	4.44	<b>RA-1061</b>	2.23	800-10,000	11.3

Collet-Lok® product line  
Swing clamps  
Work supports  
99\_078  
Linear Clamps  
Power sources  
Valves  
Pallet Components



- Ratio: 2:1
- Stroke: 2.04-4.44 inch
- Pressure: 400-5000 psi

- E** Multiplicadores
- F** Multiplicateur
- D** Betätigungszyylinder und Druckverstärker



**Options**

**Fittings**

194 ▶



**Hoses and couplers**

192 ▶



For 10,000 psi pumps, refer to the Enerpac Industrial Tools Catalog E327.



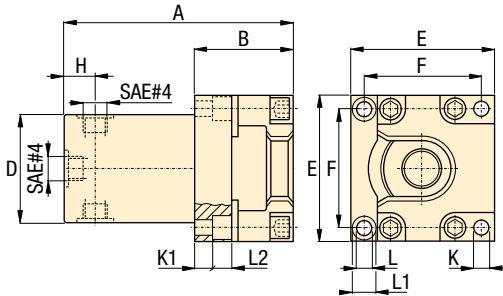
Existing fixtures with manual-connect single-acting circuits can be easily upgraded into the wand and booster.

**Important**

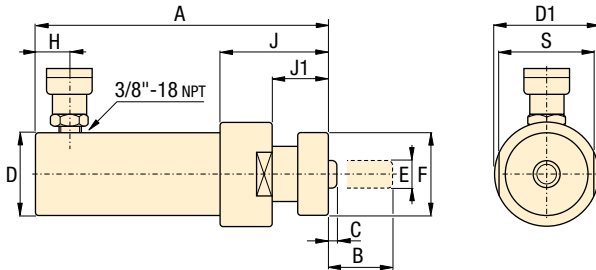
The activator wand has a 2 to 1 ratio of input pressure versus output force.

The booster output flow is 1.75 times the wand input flow.

**B-81, -171**



**RA-1061**



**Product dimensions** in inches [ ]

Model number	A	B	C	D	D1	E	F	H	J	J1	K	K1	L	L1	L2	S
<b>▼ Receiver booster</b>																
<b>B-81</b>	6.86	2.74	1.74	3.00	-	4.00	3.25	1.12	-	-	.41	2.26	.41	.62	.42	-
<b>B-171</b>	9.12	2.74	1.74	3.00	-	4.00	3.25	1.12	-	-	.41	2.26	.41	.62	.42	-
<b>▼ Activator wand</b>																
<b>RA-1061</b>	11.62	4.63	.19	2.25	3.00	.75	2.32	.75	3.02	1.53	-	-	-	-	-	2.75

Shown: WCA-62, WPA-62



▶ The automatic coupler system allows connection and disconnection of palletized hydraulic circuits. This system eliminates the direct intervention of an operator, allowing hands free, safe functioning of the process. Typical systems include one base station located at the load/unload station operating one or more pallet receivers.

■ ACCB-2 Control shown with ZW4020HJ-FHLT12U300 Pump.



■ A 4-way auto coupler is connected to the receiver, mounted on the side of a palletized fixture.



## For automated coupling of hydraulic circuits on palletized systems

- Sensing feedback of coupler position allows for fully automated applications
- Horizontal or vertical mounting for flexible installation on machine tools
- Available as 2 or 4 port model to provide a solution to various hydraulic circuit needs
- Adjustment stroke allows clearance for pallet indexing
- Coupler elements supplied with air blow-off nozzles to prevent damage from contamination
- Automatic coupler control box provides pre-programmed safety features to insure proper sequencing of automatic coupler and fixture operations



### ACCB-2, Automatic coupler control box

175 ▶

- Provides automatic or manual control of your 2 or 4 port auto coupler station.
- Panel view informs when auto coupler is retracted or advanced and whether fixture is unclamped or clamped.
- Includes 2 pressure switches, 3 proximity switches.
- Pressure switches monitor clamping and unclamping system pressure.
- Proximity switches inform PLC when auto coupler is advanced or retracted and when pallet is in position for the auto coupling.
- Integrates with ZW4020HJ-FHLT12U300 and ZW5020HJ-FHLT12U300 pumps.

## Product selection

Station position	Model number <sup>1)</sup>	Adjustable stroke	Oil capacity		Maximum oil flow <sup>2)</sup>
			in <sup>3</sup>		
		in	advance	retract	in <sup>3</sup> /min
<b>▼ 2 port auto coupler</b>					
Base	<b>WCA-62</b>	.20 - .59	.66	.66	60
Base	<b>WCA-82*</b>	4.10 - 4.48	.66	.66	60
Pallet	<b>WPA-62</b>	-	-	-	-
<b>▼ 4 port auto coupler</b>					
Base	<b>WCA-64*</b>	.20 - .59	.66	.66	60
Pallet	<b>WPA-64*</b>	-	-	-	-

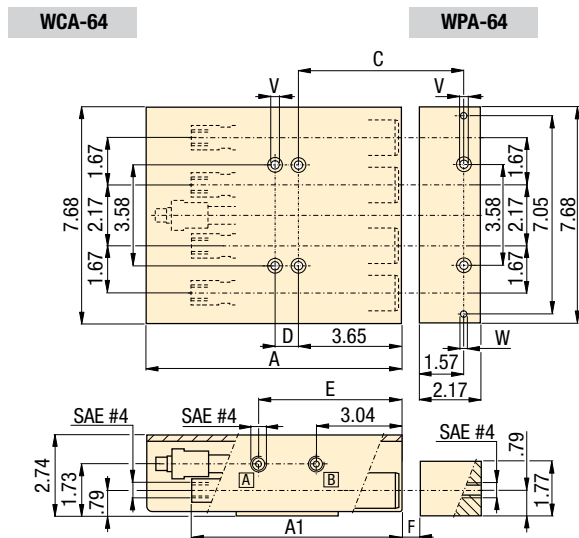
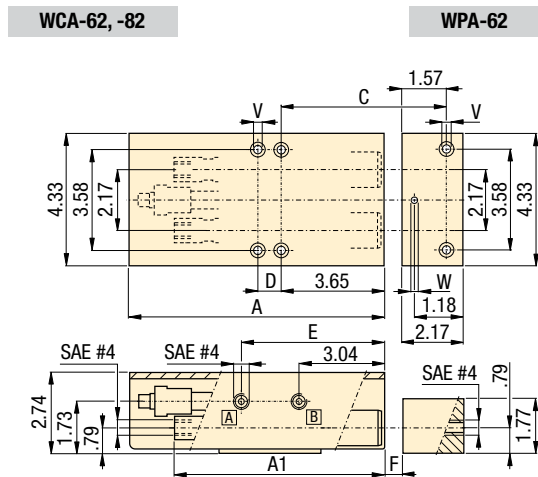
<sup>1)</sup> For additional pallet clearance, WCA-82 long stroke model are available.

<sup>2)</sup> Maximum oil flow of coupler elements is 4.3 GPM.

\* This product is made to order. Please contact Enerpac for delivery information before specifying in your design.

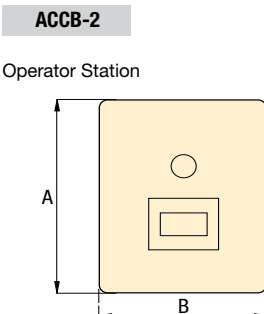
**Product specifications**

Model number	Required radial alignment accuracy in	Operating pressure psi	Hydraulic nozzle model number (included)	Air blow-off fitting model No. (included)	Recommended alignment tool
<b>▼ 2 port auto coupler</b>					
WCA-62	± .02	580 - 5000	CDF-6	FZ-2050	AT-1
WCA-82	± .02	580 - 5000	CDF-6	FZ-2050	AT-2
WPA-62	± .02	580 - 5000	CDM-6	FZ-2050	AT-1
<b>▼ 4 port auto coupler</b>					
WCA-64	± .02	580 - 5000	CDF-6	FZ-2050	AT-1
WPA-64	± .02	580 - 5000	CDM-6	FZ-2050	AT-1



Model number	Voltage / Current
<b>▼ Automatic Coupler Control Box</b>	
ACCB-2	115 VAC / 10 A

Note: Enclosure rating NEMA 12.



<b>Connection: 2-4 ports</b>
<b>Stroke: .20-4.48 inch</b>
<b>Pressure: 580-5000 psi</b>

- E** Acopladores automáticos
- F** Coupleurs automatiques
- D** Automatische Kupplungen

**Options**

**High pressure filters**

193 ▶

**AT series alignment tool**

Use the AT series alignment tool to adjust the position of the pallet station in relation to the base station.

**Hoses and couplers**

192 ▶

**Important**

Use high pressure filters on pallet station outlet ports, to avoid contamination of pallet mounted valves and cylinders.

To guarantee leakage free connections, accurate positioning of the pallet and base stations is crucial. Carefully read the instruction manual included with the product.

Do not couple or uncouple with the hydraulic nozzles under pressure. This could damage the internal coupler seals.

Do not exceed maximum flow and pressure.

**Product dimensions in inches [ ]**

Model number	A	A1	B	C	D	E	F max.	V <sup>1)</sup> for mounting bolts thread x length	W <sup>2)</sup>	lbs
<b>▼ 2 port auto couplers</b>										
WCA-62	8.86	7.48	-	5.42	.83	5.09	.394-.413	.312-18UN x 3.00	-	16.8
WCA-82*	15.67	14.03	-	9.36	3.94	8.20	3.70	.312-18UN x 3.00	-	28.8
WPA-62	-	-	-	-	-	-	-	.375-16UN x 2.00	.23	4.0
<b>▼ 4 port auto couplers</b>										
WCA-64*	8.86	7.48	-	5.42	.83	5.09	.394-.413	.312-18UN x 3.00	-	29.1
WPA-64*	-	-	-	-	-	-	-	.375-16UN x 2.00	.23	6.6
<b>▼ Automatic coupler control box<sup>3)</sup></b>										
ACCB-2	13.78	-	11.81	-	-	-	-	-	-	30.0

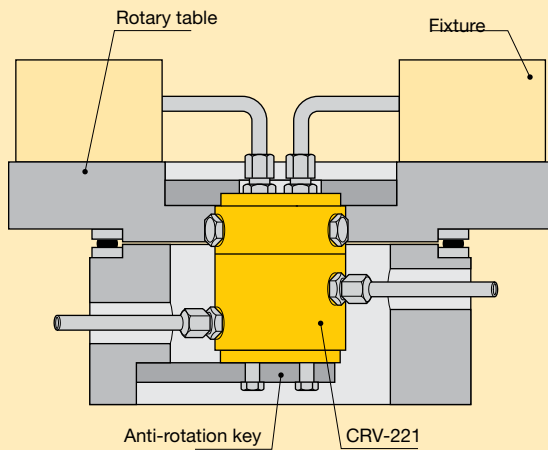
<sup>1)</sup> Mounting bolts are not included. <sup>2)</sup> Drill dowel pin holes after installing WPA.  
 \* This product is made to order. Please contact Enerpac for delivery information before specifying in your design.

# Rotary couplers *Application & selection*

Shown: CRV-221, CR-111



Rotary couplers are specially designed unions to transfer pressurized fluid from a stationary supply line to a rotating device. Used for workholding or clamping device such as fixtures installed on rotating index tables.



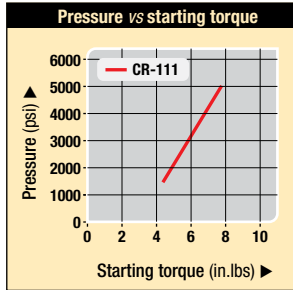
In this application eight CRV-221 rotary couplers are installed to power the individual presses of an eight station rotary press table.



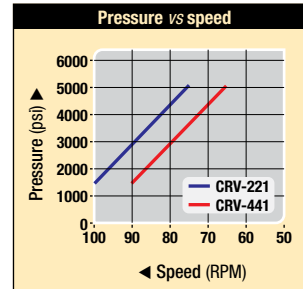
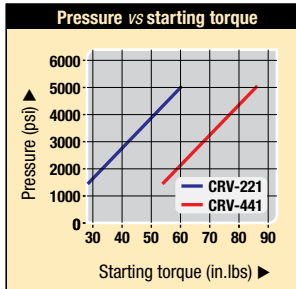
## Permanent hydraulic connection on indexing and rotating work stations

- High rotation per minute
- Low starting torque
- Internal oil bearings for increased lifetime
- Manifold mounting adaptors available to reduce fixture plumbing

### Starting torque and speed diagrams



Max. operating speed = 30 RPM.



Oil loss CRV-221 = 1.22 in<sup>3</sup>/h, CRV-441 = 2.44 in<sup>3</sup>/h

### Product selection

No. of radial passages	Model number <sup>1)</sup>	Operating pressure range	Maximum speed		Starting torque	
			RPM		in.lbs	
			psi	1500 psi	5000 psi	1500 psi
1	CR-111	1500-5000	30	30	4.5	8
2	CRV-221	1500-5000	100	75	27	60
4	CRV-441	1500-5000	90	65	53	182

<sup>1)</sup> Before selecting, note the starting torque and speed diagrams above.

### Manifold mounting adaptor



#### Mounting adaptor AMP-2, AMP-4

Mounts onto end of two and four passage rotary unions. Allows O-ring mounting directly to fixture.

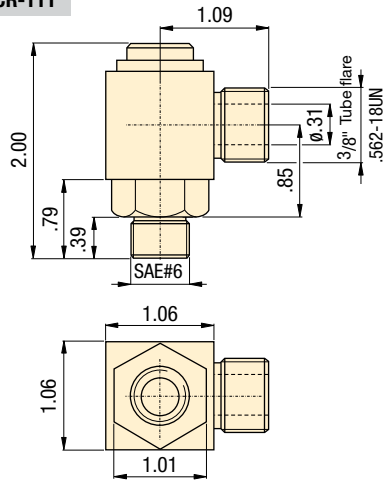
### Product selection

Number of radial passages	Model number	Operating pressure range	Used with
		psi	
2	AMP-2	1500-5000	CRV-221
4	AMP-4	1500-5000	CRV-441

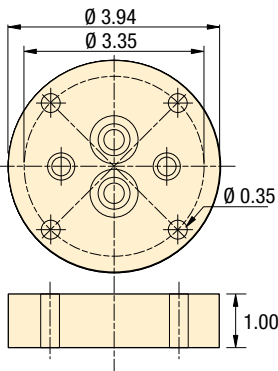


**Product dimensions** in inches [  ]

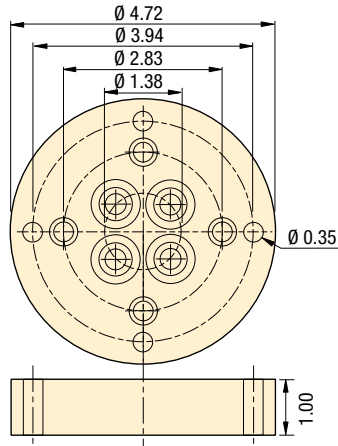
**CR-111**



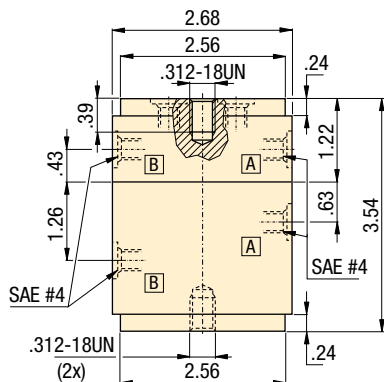
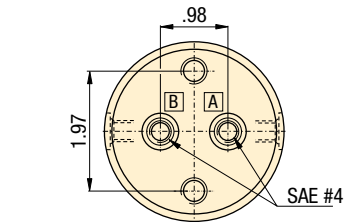
**AMP-2**



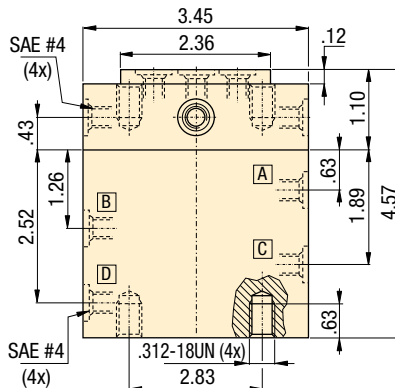
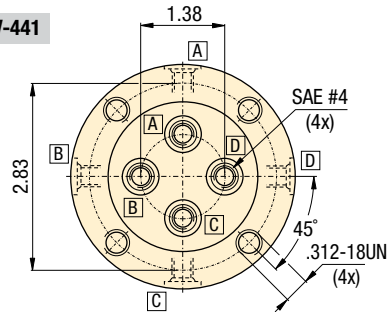
**AMP-4**



**CRV-221**



**CRV-441**

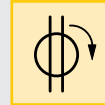


Passages: 1-4 lines

Speed: 30-100 RPM max.

Pressure: 1500-5000 psi

- E** Acoplamiento giratorio
- F** Joints tournants
- D** Drehdurchführungen



**Options**

Fittings

 194



Couplers

 192



Hoses and couplers

 192



**Important**

Before selecting, note the pressure versus starting torque diagrams.

Rotary couplers must be mounted in the center of rotation of the installation.

Anti-rotation keys should be utilized.

For proper application, clamp force, pressures and timing, consult Enerpac for support.

Shown: PID-401



## PID series

When hydraulic pressure from an existing power source is limited, Enerpac oil-to-oil intensifiers serve to increase output pressure to satisfy the required application.

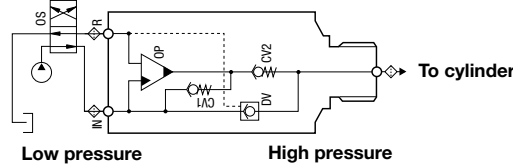
## High flow units intensify low inlet oil pressure to high outlet pressure

- Internal bypass valving enables high output flow rates
- Wide range of intensification ratios allows for adapting to various operating pressure requirements
- Compact and self-contained design allows for ease of installation
- Includes dump valve eliminating the need for an external pilot check valve
- Select fit of all internal components provides long operating life

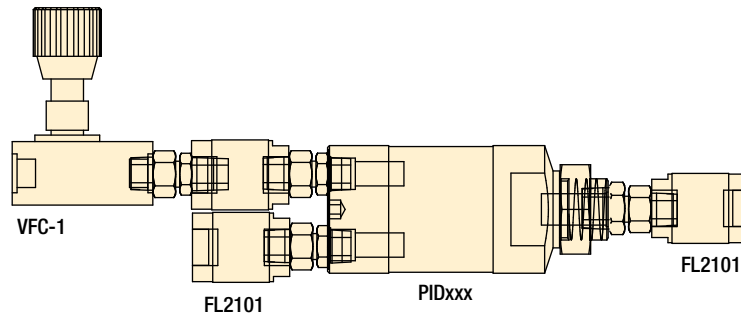
## Intensifier principle

- When oil is supplied to the inlet (IN) port it flows freely past the check valves (CV) and the dump valve to the cylinder and advances it.
- As the inlet pressure increases the oscillating pump (OP) automatically increases the outlet pressure by the chosen intensification.
- Once the maximum pressure is reached, the pump frequency lowers and balances at the maximum pressure.
- Free flow from the cylinder to tank occurs when the directional control valve is switched to supply the R-port.
- 10 micron filtration is required on all ports in the circuit to ensure trouble free operation. Filters and flow control included.

### PID Series



### PID-xxxF intensifier



■ PID-Series intensifier utilizes low pressure machine hydraulics to power clamping cylinders.



## Product selection

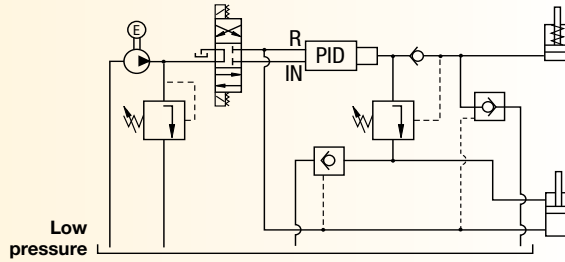
Maximum pressure	Pressure intensification ratio	Maximum input flow	Maximum output flow	Model number	Inlet pressure range	lbs
psi		in <sup>3</sup> /min	in <sup>3</sup> /min	with dump valve	psi	
10,000	1 : 3.2	610	150	PID-321F	300 - 1560	2.6
10,000	1 : 4.0	580	120	PID-401F	300 - 1250	2.6
10,000	1 : 5.0	550	95	PID-501F	300 - 1000	2.6
10,000	1 : 6.6	530	75	PID-661F	300 - 750	2.6

\* Operating pressures above 5000 psi require high pressure fittings or intensifier models with BSPP ports. Contact Enerpac for details.

**i System set-up information:**

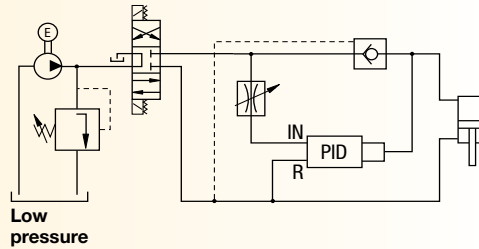
**With dump valve (PID models)**

The intensifier with the dump valve is used to achieve high pressure on the advance side of a double-acting cylinder.

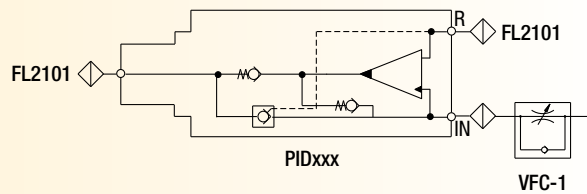


**With external dump valve**

In a system where the pump's oil flow is higher than the maximum inlet oil flow of the intensifier, an external check valve and flow control valve reduces the pump's oil flow.



This application can be set up when machines are equipped with low pressure hydraulics but the pressure to clamp the workpiece must be higher.



Ratio: 1:3.2-1:6.6

Flow: 75-150 in<sup>3</sup>/min

Pressure: 960-10,000 psi

- E** Multiplicadores
- F** Multiplicateur
- D** Öl-Öl Druckübersetzer



**Options**

**FL-series, high-pressure filters**

193 ▶



**Directional valves**

135 ▶



**FZ-series fittings**

194 ▶



**! Important**

Do not exceed maximum allowable inlet pressure.

10 micron filtration is included to ensure trouble-free operation.

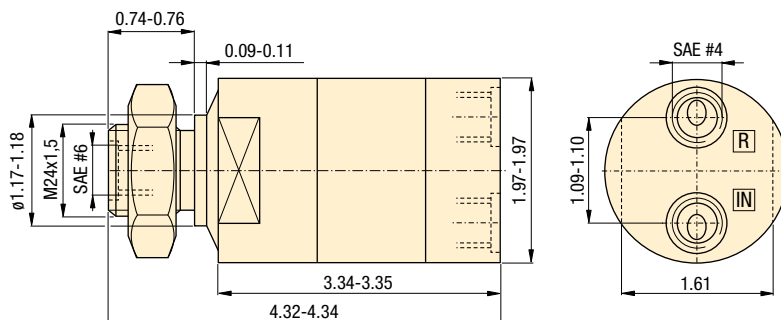
Applications above 5000 psi require high pressure fittings or intensifier models with BSPP ports. Contact Enerpac for details.

PID models with dump valve provide an economical means of relieving pressure from the system.

Can be panel mounted into machine (M24x1,5 thread).

**A Product dimensions in inches [ ]**

**PID series**



Shown: SLS-2



▶ SafeLink provides wireless communication between the fixture mounted SEND unit and the machine control interfaced RECEIVE unit.

A pressure switch is used on the fixture to monitor the circuit pressure. If the pressure switch on the fixture goes open, the RECEIVE unit communicates the changed status to the machine control through either 24 VDC, Modbus RTU RS485 or Ethernet IP protocol or Modbus TCP/IP.

The machine control would interrupt the machining process. The SEND unit can also be used with limit switch based position sensing clamps to verify clamped or unclamped status for robotically loaded systems.

## WIRELESS communication between a fixture circuit and the machine control

- Fixture mounted “SEND” unit uses radio communication to monitor pressure and/or clamp position
- 2.4 GHz Frequency Band for global acceptance
- “Frequency Hopping” used to for signal stability, even in busy production environments
- “SEND” units are easily reassigned to a different “RECEIVE” unit so fixtures can be moved between machines
- No limit to the number of systems used in a production area
- “SEND” units are internally powered by a replaceable 3.6 VDC Lithium battery – provides up to 3-year battery life
- “SEND” units are sealed to IP-67 for protection from contamination and coolant
- LED lights for visual status indication
- LCD Display window for set-up and status display

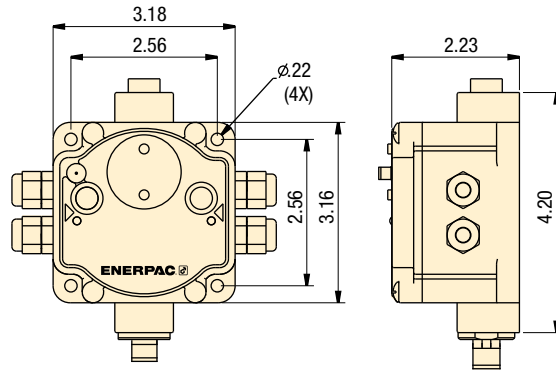
Model Number	Description
SLS-1	“SEND” Unit with Internal Antenna
SLS-2	“SEND” Unit with External Antenna
SLS-3	“SEND” Unit with External Antenna, 3 Inputs
SLR-1	“RECEIVE” Unit with External Antenna
SLR-2	“RECEIVE” Unit with External Antenna, 3 Inputs
SLS-2AC	.2m Antenna Cable
SLEM-1	Expansion Module for SLR
SLEB-1	Ethernet Bridge for SLR-1
SLSC-1	Power and Communication Splitter Cable for SLEB-1
SLDB-1	DIN Rail Mounting Bracket

## Product specifications

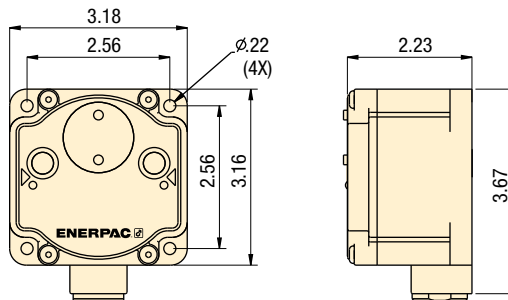
IP Rating	Radio Frequency	Transmit Power	Input Power for RECEIVE Unit	Outputs	FCC Rating	Receiver Communication Protocols	Additional Outputs available from Receiver
IP 67	2.4 GHz	21 dBm	+10 VDC	+24 VDC	FCC	Modbus	24 VDC
		conducted	to		Part 15,	RTU RS485	
			+30 VDC		Subpart C,		
					15.247	Ethernet IP	
Dust tight,	Global		Supplied	NMOS			Max
immersion	Standard		by machine	Sinking		Modbus	from
up to 1			control			TCP/IP	Receiver:
meter							6

Collet-Lok® product line  
 Swing clamps  
 Work supports  
 Linear Clamps  
 Power sources  
 Valves  
 Pallet Components

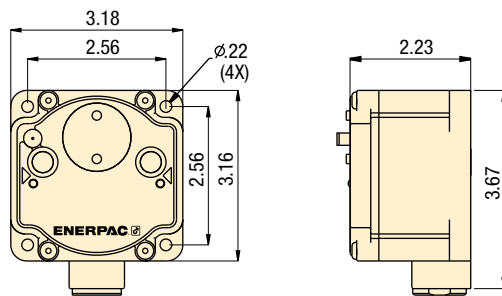
**SLR-1 / SLR-2 RECEIVE UNIT**



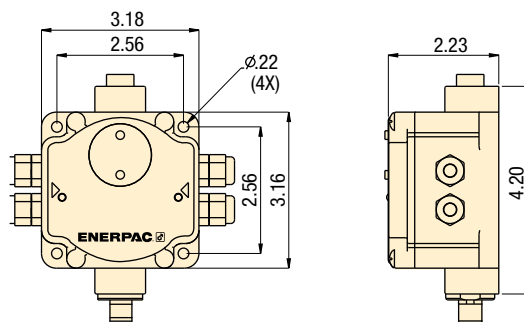
**SLS-1 SEND UNIT**



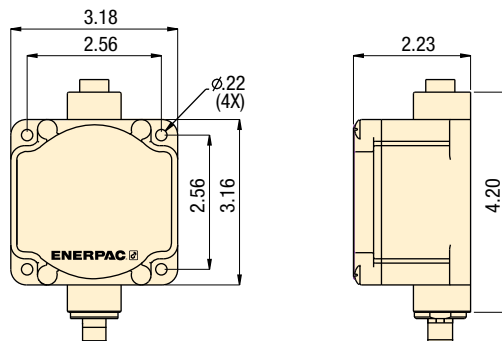
**SLS-2 / SLS-3 SEND UNIT**



**SLEM-1 EXPANSION MODULE**



**SLEB-1 ETHERNET BRIDGE**



**Radio Frequency: 2.4 GHz**

**IP Rating: 67**

**Communication protocols:  
Modbus RTU RS485  
Ethernet TCP IP**

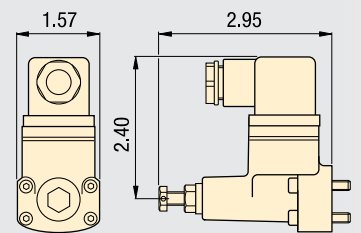
- E** Monitoreo Inalámbrico
- F** Contrôle sans fil
- D** Drahtlose Überwachung

**! Important**

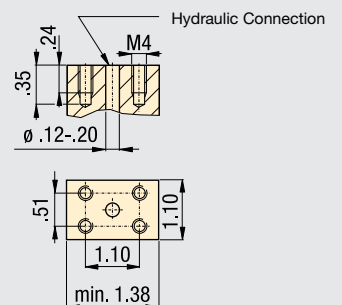
**A Pressure Switch is required to monitor the pressure in the fixture circuit. For a convenient manifold mount model, use the PSCK-8 or PSCK-9 from Enerpac.**

**Manifold Mount Pressure Switch**

IP Rating: 65 (Dust and Water Jet)  
 PSCK-8: Range 1450-5000 psi (100-345 bar)  
 PSCK-9: Range 290-3045 psi (20-210 bar)



**Mounting Dimensions**

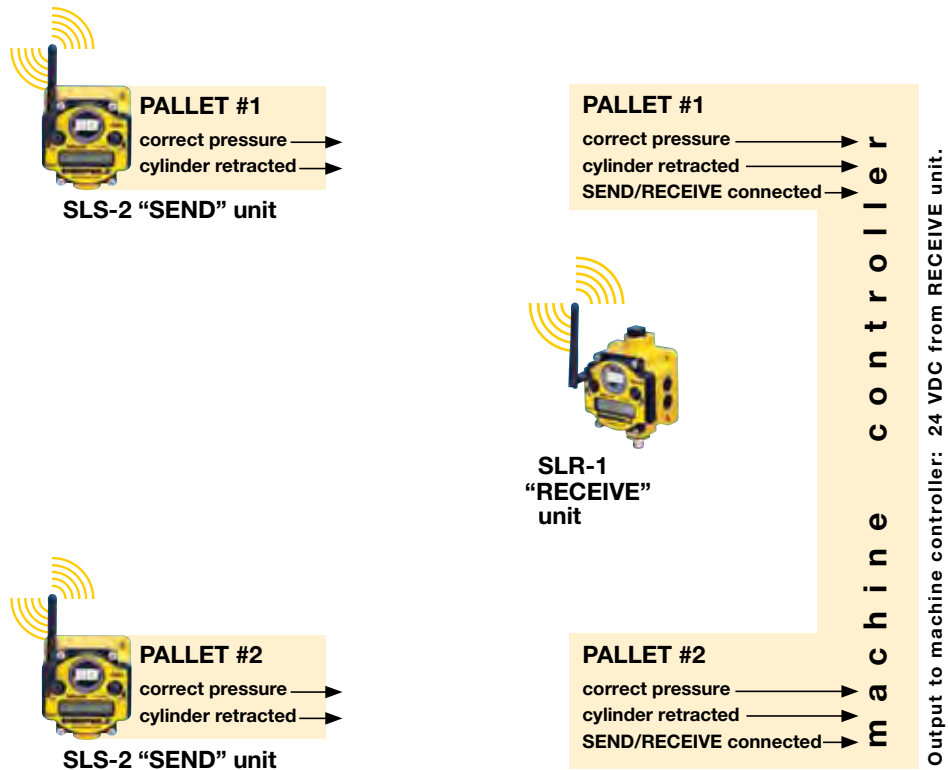


Shown: SLS-1

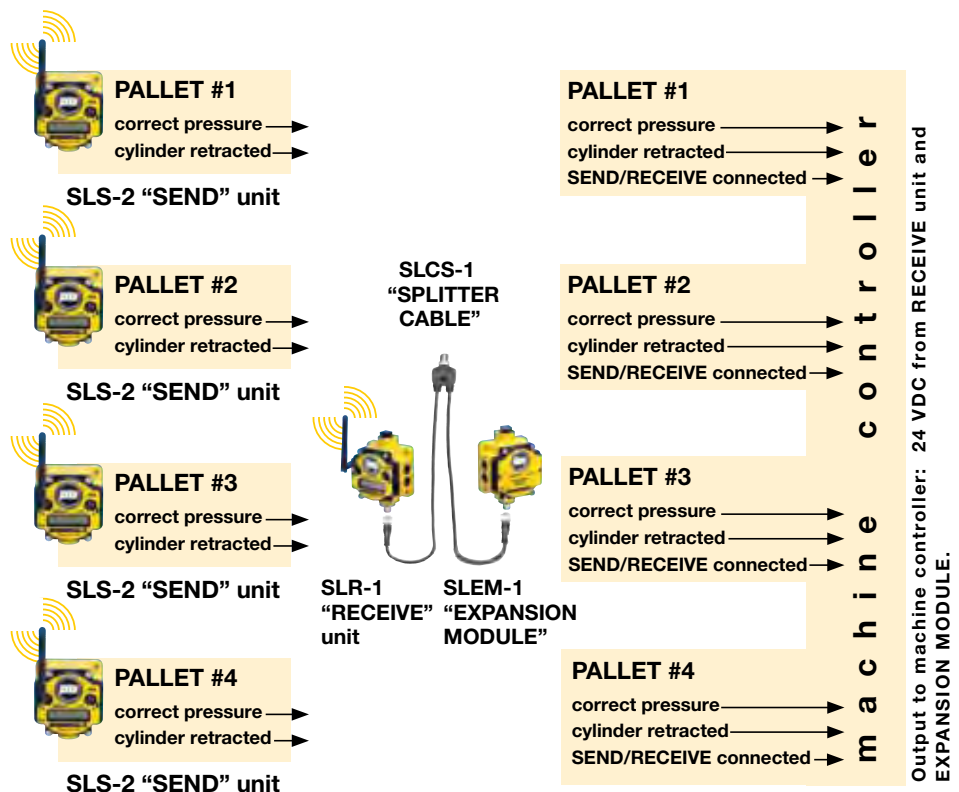


SafeLink can provide a discrete 24VDC output signal for systems of up to 4 fixtures. Each SEND unit can provide up to three outputs to the RECEIVE unit. The RECEIVE unit has 6 terminal stations, which are assigned to SEND units in groups of 3. So each RECEIVE unit can be paired with 2 SEND units when using the 24VDC output. For extra capacity, an EXPANSION MODULE provides an additional terminal strip, adding 2 more sets of three terminal stations.

## Basic System with I/O Machine Interface



## Larger System with I/O Machine Interface



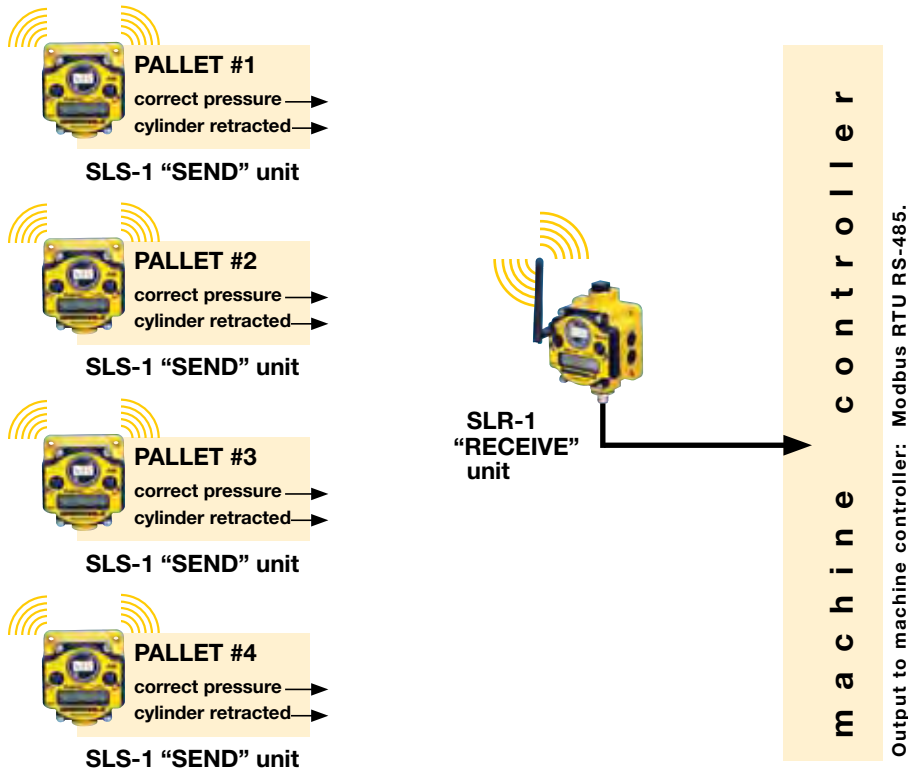
### SLCS-1 Splitter Cable

The **SLSC-1 Splitter Cable** is used with the **SLEM-1 Expansion Module** and the **SLEB-1 Ethernet Bridge** to connect to the **SLR-1 RECEIVE** unit and the machine control circuit.



Collet-Lok® product line  
Swing clamps  
Work supports  
Linear Clamps  
Power sources  
Valves  
Pallet Components

**Larger System with Modbus RTU Machine Interface**

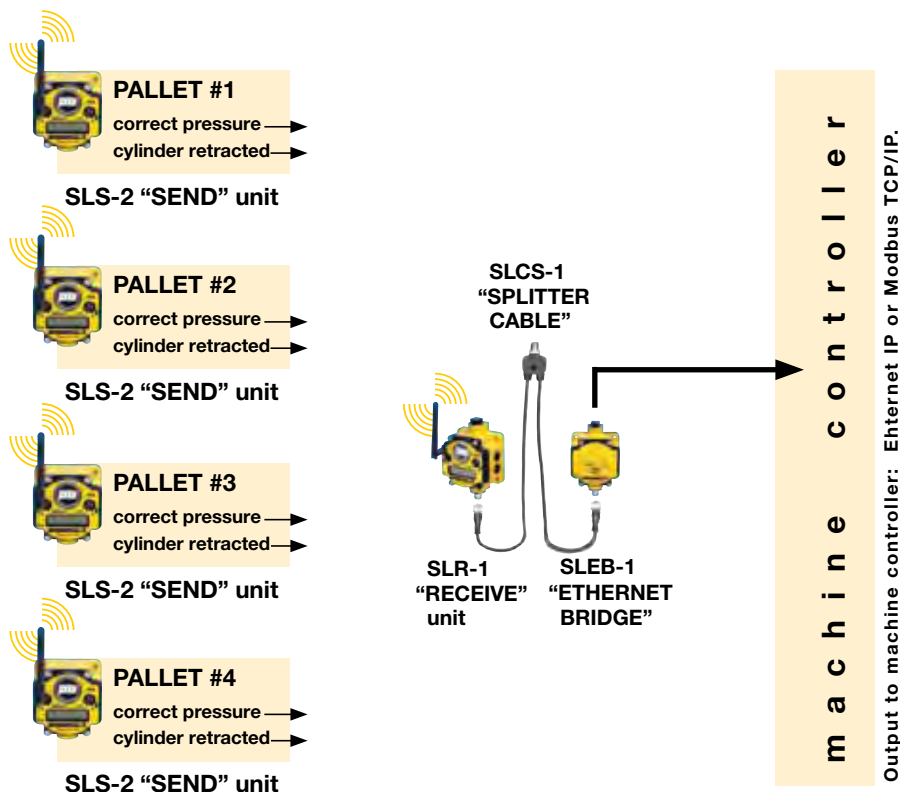


Shown: SLR-1



SafeLink RECEIVE units can supply the outputs by using the standard Modbus RTU RS-485 protocol. This output uses the 5 pin connector on the RECEIVE unit. If Ethernet protocol is preferred, an ETHERNET BRIDGE is available to convert the Modbus RTU R-485 to ETHERNET IP or Modbus TCP/IP.

**Larger System with Ethernet IP Machine Interface**



Shown: SLEB-1



The SLEB-1 Ethernet Bridge is used with the SLR-1 Receiver when Ethernet connection is available in the machine control. Use of the SLEB-1 will allow the monitoring of more fixtures in a large pallet pool system.

Shown: SLR-1



▶ SafeLink provides wireless communication between the fixture mounted SEND unit and the machine control interfaced RECEIVE unit. If the pressure switch on the fixture goes open, the RECEIVE unit communicates the changed status to the machine control through either 24 VDC Modbus RTU RS485 or Ethernet TCP IP protocol. The machine control would interrupt the machining process. The SEND unit can also be used with limit switch based position sensing clamps to verify clamped or unclamped status for robotically loaded systems.

## ▶ WHAT IS SAFE LINK?

SafeLink is a wireless way to communicate between a palletized fixture and a machine control.

## ▶ WHY USE SAFE LINK?

SafeLink can monitor the fixture pressure and clamp position in real time- even when parts are being machined. The system can also be used to verify that the operator has properly pressurized the fixture before it is sent in to be machined. If there is a pressure deficiency, the signal between the Send and Receive units is interrupted, and the machine control can respond before expensive damage occurs.

## ▶ HOW DOES SAFE LINK WORK?

SafeLink uses 2.4 GHz radios to allow the SEND unit on the fixture to communicate with the RECEIVE unit that is interfaced with the machine control. The RECEIVE unit provides both 24 VDC outputs and a standard Modbus RTU RS485 communication protocol. An optional Ethernet Bridge will convert this to an Ethernet TCP IP protocol. The machine control must be set up to respond to this protocol to initiate a Feed Hold command, turn on a warning light, or even activate a Machine Stop command.

A pressure switch for pressure monitoring or a limit switch for position sensing is used with the SEND unit. If the pressure or position is lost, the switch goes open and the signal to the RECEIVE unit is interrupted.

## ▶ WHAT POWERS THE SEND UNIT?

The SEND unit uses a 3.6 VDC size D Lithium battery that is supplied with the unit.

Projected battery life is 3 years.

## ▶ WHAT POWERS THE RECEIVE UNIT?

The receive unit requires 24 VDC power, usually from the power supply in the machine control.

## ▶ WILL THE MACHINE FAULT IF THE PALLET IS IN THE LOADING STATION AND THE CLAMPS ARE UNCLAMPED?

The Receive unit is just an input source for the machine control. The machine control must be able to identify which fixture is in the machine being run and which one is in the loading station. When in the loading station, the machine control must be able to ignore the signal loss when the clamps are unclamped to remove the completed parts.

## ▶ HOW MANY FIXTURES CAN BE MONITORED BY ONE RECEIVE UNIT?

By using either Modbus RTU RS485 or Ethernet TCP IP, up to 56 SLS-1 or SLS-2 Send Units on fixtures can be monitored by a single SLR-1 Receive Unit.

## ▶ IS INSTALLATION AVAILABLE FROM ENERPAC?

Enerpac has partnered with a CNC control specialist that can quote custom installation services. Contact your Enerpac Territory Manager for details.



# SafeLink Monitoring System Worksheet

## SAFE LINK PALLET MONITORING SYSTEM

FOR CUSTOMERS WHO REQUIRE CUSTOM INSTALLATION OF THE ENERPAC SAFE LINK PALLET MONITORING SYSTEM, PLEASE PROVIDE THE FOLLOWING INFORMATION FOR EACH MACHINE TOOL TO BE EVALUATED:

COMPANY: \_\_\_\_\_ CITY, STATE, ZIP: \_\_\_\_\_  
 CONTACT: \_\_\_\_\_ CONTACT PHONE (EXT): \_\_\_\_\_  
 ADDRESS: \_\_\_\_\_ CONTACT EMAIL: \_\_\_\_\_

### BUDGET

BUDGET FOR CUSTOM INSTALLATION OF SAFE LINK SYSTEM ON THIS MACHINE TOOL:

\$500	\$1000	\$2500	\$5000+
-------	--------	--------	---------

### MACHINE INFORMATION

MACHINE MAKE	
MACHINE MODEL	
MACHINE SERIAL NUMBER	
MACHINE TYPE	
SINGLE BED HORIZONTAL MACHINING CENTER	
PALLET POOL CELL WITH HORIZONTAL MACHINING CENTERS	
NUMBER OF MACHINES IN CELL	
SINGLE BED VERTICAL MACHINING CENTER	
TWO PALLET VERTICAL MACHINING CENTER	
SLIDE BY	
VERTICAL TURRET LATHE (VTL)	
OTHER/DESCRIBE	
NUMBER OF FIXTURES ASSOCIATED WITH THIS MACHINE	
TOTAL NUMBER OF CIRCUITS IN FIXTURE GROUP	

### MACHINE CONTROL INFORMATION

MACHINE CONTROL/MAKE				
MACHINE CONTROL/MODEL NUMBER				
MACHINE CONTROL/SERIAL NUMBER				
MACHINE CONTROL INTERFACE AVAILABLE	MODBUS	ETHERNET	DEVICENET	RELAY
	SERIAL RS-232	OTHER/DESCRIBE		
MACHINE CONTROL IP ADDRESS				
ACTION IF FAULT IS DETECTED	FEEDHOLD		ACTIVATE A LIGHT	
	MACHINE STOP		OTHER/DESCRIBE	

CONTACT ENERPAC: INFO@ENERPAC.COM • PHONE 414-747-8315 • FAX 414-769-9247

# System

## System Components

From the simplest to the most complex hydraulic system, Enerpac's system components help you complete your design. Gauges, pressure switches, couplers and hoses are simple but necessary items for any hydraulic system, and Enerpac can provide the full range.










## Technical support

- Safety instructions
- Basic hydraulic information
- Advanced hydraulic technology
- FMS (Flexible Machining Systems) technology
- Conversion charts and hydraulic symbols

 197 ▶

# components

	▼ series	▼ page	
Pressure switches	IC, PB PSCK	188	
Digital pressure gauges	DG	189	
Pressure gauges	G	190	
Gauge accessories	GA, GS NV, FM	191	
Manifolds, couplers, hoses, tubing	A, AH/R HLS, H, T	192	
High pressure filters, hydraulic oil	FL, HF	193	
High pressure fittings	BFZ, FZ	194-196	

Shown: PSCK-8, IC-51



**Enerpac remote mounted pressure switches monitor the hydraulic system to determine any change of pressure. The signal can then be used to control the pump, or other peripheral devices.**

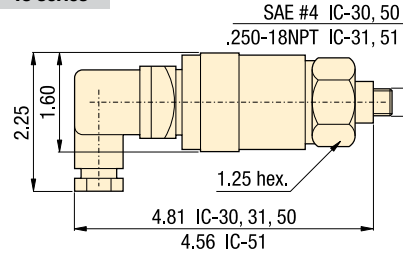
### IC-series

The IC-series electrical pressure switches provide pressure readings for monitoring and/or control of hydraulic system pressure in workholding systems.

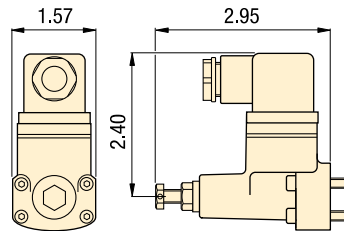
## Reliable electrical control of hydraulic power

- Compact design minimizes space requirements on fixture
- Switch is easily adjustable to meet system requirements

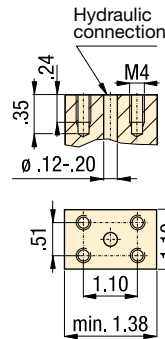
### IC series



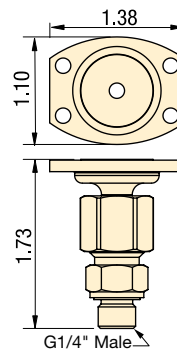
### PSCK-8, 9



### mounting dimensions



### PB-4



■ *Integrated in your hydraulic system, the pressure switch can be used to automate your clamping cycles.*



**Pressure: 500-7500 psi**

**Accuracy: 2%**

- (E)** Presostatos
- (F)** Pressostats
- (D)** Druckschalter



## Options

### Fittings



194 ▶

### Gauges



190 ▶

## Important

**Do not exceed the maximum pressure.**

## Product selection

Adjustable pressure range	Electrical specifications	Model number	Deadband	Switch point repeatability	Oil port	lb
psi	at 50/60 Hz		psi	% of range		
<b>▼ Electrical pressure switches</b>						
500-3500	125 VAC @ 5 A	<b>IC-30</b>	100 - 500	+ /-2	SAE #4	1.0
500-3500	125 VAC @ 5 A	<b>IC-31</b>	100 - 500	+ /-2	.250-18 NPT	1.0
3000-7500	125 VAC @ 5 A	<b>IC-50</b>	250 - 800	+ /-2	SAE #4	1.0
3000-7500	125 VAC @ 5 A	<b>IC-51</b>	250 - 800	+ /-2	.250-18 NPT	1.0
1450-5000	115 VAC @ 2 A	<b>PSCK-8</b>	250 - 800	+ /-2	Manifold mount	0.8
290-3045	115 VAC @ 2 A	<b>PSCK-9</b>	250 - 800	+ /-2	Manifold mount	0.8
-	-	<b>PB-4</b>	-	-	G 1/4"	.25

Collet-Lok® product line  
 Swing clamps  
 Work supports  
 Linear clamps  
 Power sources  
 Valves  
 Pallet components  
 System components

Pressure: 0-20,000 psi

Accuracy: ± 0.25%

Voltage: 3 VDC (battery)

- E** Manómetros digitales
- F** Manomètres digitaux
- D** Digitale Manometer

## Options

### Fittings

194 ▶



### Gauge adaptors

190 ▶



## Important

Do not exceed the maximum pressure.

Gauges can be easily installed into the hydraulic system using GA-3 gauge adaptor.

191 ▶

### Protective cover included

Fits over face of gauge for protection in harsh environments.

## Easy and precise pressure monitoring

### DGR-2

- Rated for system pressure up to 20,000 psi
- Displays in multiple units: psi, bar, mPA, kg/cm<sup>2</sup> (user selectable)
- Zero reset – ensures that gauge reads actual system pressure
- Batteries included, condition indicator on readout
- IP65 rated case design
- Shut off selectable – menu driven
- UL listed, CE and RoHS compliant

Shown: DGR-2



DGR-1B

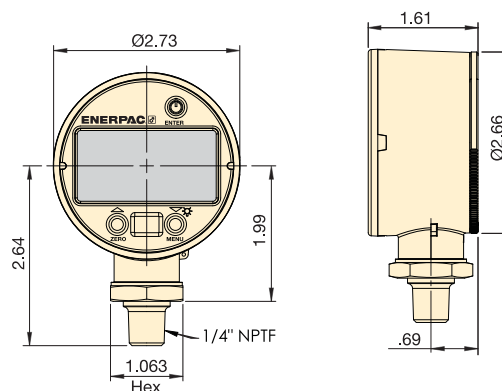
▶ Enerpac digital pressure gauges offer greater accuracy and are easier to read than conventional dial gauges, greatly enhancing your ability to monitor and control hydraulic system pressure.

### DGR-2 Remote Operation

Battery operated for additional flexibility. Includes maximum and minimum pressure capture.

### Back-lit Readout

Back-lit readout allows easy reading in less than ideal lighting.



## Product selection

Pressure rating		Model	Pressure rating		Pressure rating		Pressure rating		Pressure rating
psi			bar		MPa		Kg/cm <sup>2</sup>		lbs
Range	Resolution		Range	Resolution	Range	Resolution	Range	Resolution	
0-20,000	1	<b>DGR-2</b>	0-1380	0.1	0-140	0.01	0-1400	0.1	0.5

Shown: GS-2, G-2512L, GS-3



## Enerpac gauges provide a safe and inexpensive monitoring system for your hydraulic circuit

### Highly reliable and accurate pressure sensing

- ± 1.5% accuracy of full scale
- All pressure sensing parts sealed and dampened by glycerine for long life
- Includes safety blow-out disk and pressure equalizing membrane to prevent overpressurization
- Copper alloy, coiled safety Bourdon tube for 1000 psi and higher
- Dual psi and bar scale readings, 2.5 inch gauge face

### Gauge accessories for easy installation

- Needle valves providing positive shut-off
- 303 stainless steel stem (NV-251)
- Snubber valves to control pressure surges between gauge and hydraulic system
- Gauge adaptors – male end screws into pump or cylinder, female port accepts hose or coupler, the third port is for gauge connection
- FM-25NG for panel mounting of 2.50 inch diameter gauges

### Product selection

Pressure gauge mounting style	Pressure range		Model number	PSI graduation		Bar graduation		A in	B in	D in	G
	psi	bar		Major psi	Minor psi	Major bar	Minor bar				
<b>▼ Pressure gauge – Lower mount</b>											
	0-100	0-7	<b>G-2509L</b>	10	2	1	0,01	3.31	1.46	2.50	1/4" NPT
	0-160	0-11	<b>G-2510L</b>	10	2	1	0,02	3.31	1.46	2.50	1/4" NPT
	0-200	0-14	<b>G-2511L</b>	50	5	1	0,02	3.31	1.46	2.50	1/4" NPT
	0-300	0-20	<b>G-2512L</b>	50	5	5	0,05	3.31	1.46	2.50	1/4" NPT
	0-600	0-40	<b>G-2513L</b>	100	10	10	1	3.31	1.46	2.50	1/4" NPT
	0-1000	0-70	<b>G-2514L</b>	100	20	10	1	3.31	1.46	2.50	1/4" NPT
	0-2000	0-140	<b>G-2515L</b>	500	50	10	2	3.31	1.46	2.50	1/4" NPT
	0-3000	0-200	<b>G-2516L</b>	500	50	50	5	3.31	1.46	2.50	1/4" NPT
	0-6000	0-400	<b>G-2517L</b>	1000	100	100	10	3.31	1.46	2.50	1/4" NPT
	0-10,000	0-700	<b>G-2535L</b>	2000	200	100	10	3.31	1.46	2.50	1/4" NPT
	0-1000	0-70	<b>G-2514SL</b>	100	20	10	1	3.66	1.23	2.50	SAE#4
	0-3000	0-200	<b>G-2516SL</b>	500	50	50	5	3.66	1.23	2.50	SAE#4
	0-6000	0-400	<b>G-2517SL</b>	1000	100	100	10	3.66	1.23	2.50	SAE#4
	0-10,000	0-700	<b>G-2535SL</b>	2000	200	100	10	3.66	1.23	2.50	SAE#4
<b>▼ Pressure gauge – Rear mount</b>											
	0-1000	0-70	<b>G-2531R</b>	100	20	10	1	2.48	1.46	2.50	1/4" NPT
	0-6000	0-400	<b>G-2534R</b>	1000	100	100	10	2.48	1.46	2.50	1/4" NPT
	0-10,000	0-700	<b>G-2537R</b>	2000	200	100	10	2.48	1.46	2.50	1/4" NPT
	0-1000	0-70	<b>G-2531SR</b>	100	20	10	1	2.46	1.23	2.50	SAE #4
	0-3000	0-200	<b>G-2533SR</b>	500	50	50	5	2.46	1.23	2.50	SAE #4
	0-6000	0-400	<b>G-2534SR</b>	1000	100	100	10	2.46	1.23	2.50	SAE #4
	0-10,000	0-700	<b>G-2537SR</b>	2000	200	100	10	2.46	1.23	2.50	SAE #4
	0-1000	0-70	<b>1531R</b>	100	20	10	1	1.99	0.98	1.50	1/8" NPT
	0-3000	0-200	<b>1533R</b>	500	100	50	10	1.99	0.98	1.50	1/8" NPT
	0-6000	0-400	<b>1534R</b>	1000	100	100	10	1.99	0.98	1.50	1/8" NPT
	0-10,000	0-700	<b>1537R</b>	2000	200	100	10	1.99	0.98	1.50	1/8" NPT

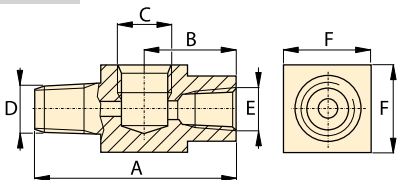
Collet-Lok® product line  
 Swing clamps  
 Work supports  
 Linear clamps  
 Power sources  
 Valves  
 Pallet components  
 System components

Pressure: 0-10,000 psi

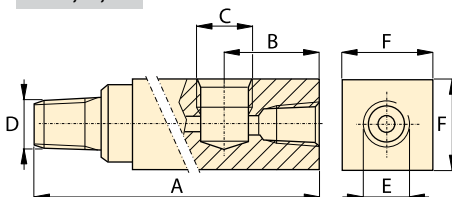
Accuracy: 1.5% /full scale

Gauge face: ø 2.5 inch

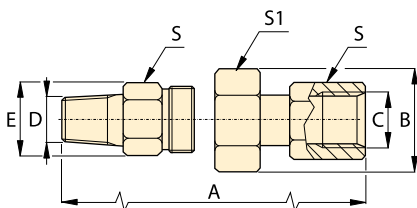
GA-1



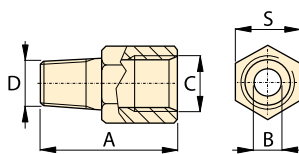
GA-2, -3, -4



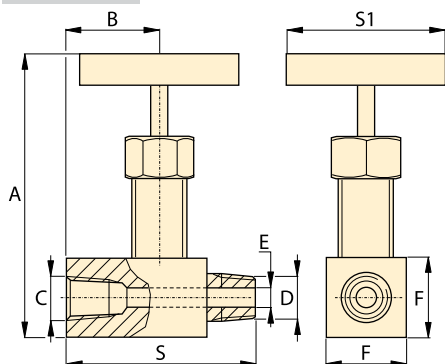
GA-918



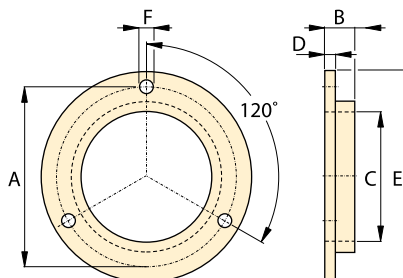
GS-2, -3



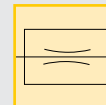
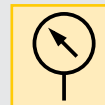
NV-251, V-91



FM-25NG



- E** Manómetros
- F** Manomètres
- D** Manometer



**Options**

Hoses and couplers

192 ▶



Digital gauges

189 ▶



Pressure switches

188 ▶



V-10 Auto Damper® valve

157 ▶



**Important**

Do not exceed maximum pressure.

Gauge snubbers or needle valves are recommended for high cycle applications.

Do not keep gauges under permanent pressure. The use of shut-off valves is recommended.

For basic system set-up information, refer to our "Yellow Pages" section.

202 ▶

**Product dimensions** in inches [ ]

Gauge port NPT	Max. pressure psi	Model number	Dimensions							
			A	B	C	D	E	F	S	S1
<b>▼ Gauge adaptors</b>										
1/2"	10,000	<b>GA-1</b>	2.81	1.24	1/2"NPT	3/8"NPT	3/8"NPT	1.25	-	-
1/2"	10,000	<b>GA-2</b>	6.10	1.38	1/2"NPT	3/8"NPT	3/8"NPT	1.25	-	-
1/4"	10,000	<b>GA-3</b>	5.25	1.38	1/4"NPT	3/8"NPT	3/8"NPT	1.25	-	-
1/2"	10,000	<b>GA-4</b>	4.38	1.38	1/2"NPT	1/4"NPT	3/8"NPT	1.25	-	-
<b>▼ Swivel gauge adaptor</b>										
1/2"	10,000	<b>GA-918</b>	2.25	1.72	1/2"NPT	1/2"NPT	1.30	-	1.13	1.50
<b>▼ Gauge shut-off valves</b>										
1/4"	10,000	<b>NV-251</b>	2.25	1.14	1/4"NPT	1/4"NPT	.17	.75	2.25	2.50
1/2"	10,000	<b>V-91</b>	3.50	1.25	1/2"NPT	1/2"NPT	.19	1.25	2.50	2.50
<b>▼ Gauge snubber valves</b>										
1/4"	5000	<b>GS-2</b>	1.63	.018	1/4"NPT	SAE #4	-	-	.75	-
1/4"	5000	<b>GS-3</b>	1.63	.018	1/4"NPT	G1/4"	-	-	.75	-
<b>▼ Flange mounting for panel mounting of G series gauges</b>										
-	-	<b>FM-25NG</b>	2.95	.17	2.51	.07	3.35	.14	-	-

# Manifolds, couplers, hoses, tubing

Shown: HLS, HF, AH, AR, FL, T, A-series



**Use genuine Enerpac manifolds, couplers, hoses and tubings to connect your workholding cylinders or fixtures to the hydraulic power source.**

## A series, Manifolds

For multiple hydraulic line connections at one central location directing oil to or from a pressure source.

## AH/AR series, Couplers

Quick disconnect low leakage couplers for easy connection of hydraulic circuits.

## HLS series, Hoses

High pressure hydraulic hoses, featuring a heavy-duty protective plastic coating.

## T-series, Tubing

High pressure steel tubing, available in 5 ft. lengths.

## Manifolds

- Easy to connect
- Mounting holes on all models

## Couplers

- Spee-D-Coupler® design allows cylinder to be connected and disconnected in seconds
- For more safety: couplers cannot be connected or disconnected while under hydraulic pressure

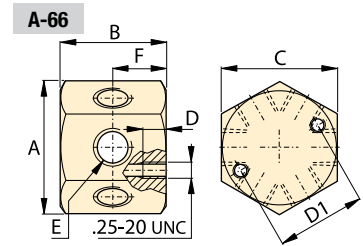
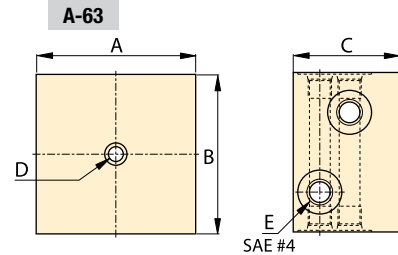
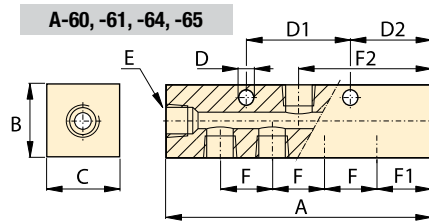
## Hydraulic hoses and tubings

- Heavy-duty coating for abrasion resistance
- Resistant against mineral based hydraulic oil as well as water glycols
- High pressure steel tubing for permanent installations

## Important

**Do not exceed the maximum pressure.**

**Inspect hoses and tubing frequently and replace as required.**



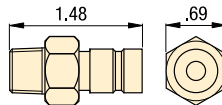
## Manifolds dimensions in inches [ $\varnothing$ ]

Number of ports	Model number	A	B	C	D	D1	D2	E	F	F1	F2	lbs
2 x 4	A-63	3.00	3.00	2.00	.25	-	-	SAE #4	-	-	-	2.0
5	A-60	3.50	1.25	1.25	.28	1.50	1.00	SAE #4	1.50	1.00	1.75	1.0
7	A-61	6.50	1.25	1.25	.28	1.50	1.25	SAE #4	1.00	1.25	3.25	1.4
7	A-64	7.00	1.25	1.25	.25	3.00	1.25	.375-18 NPT	1.50	1.25	3.50	3.3
7	A-65	14.5	1.25	1.25	.25	8.00	1.25	.375-18 NPT	4.00	1.25	7.25	6.1
6	A-66	2.30	1.63	2.00	.52	1.50	-	.375-18 NPT	-	-	-	1.8

## Couplers

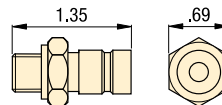
### AH-650

Male coupler half  
.250-18 NPT



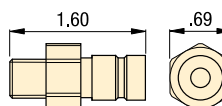
### AH-652

Male coupler half  
G1/4" BSPP



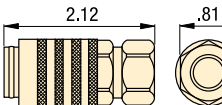
### AH-654

Male coupler half  
SAE #4 .437-20 UNF



### AR-650

Female coupler half  
.250-18 NPT



## Hoses

Length	Model number	Internal diameter	Maximum pressure
ft		in	psi
<b>▼ 1/4", 37° flare</b>			
1	HLS-512	.19	5000
2	HLS-524	.19	5000
3	HLS-536	.19	5000
4	HLS-548	.19	5000
5	HLS-560	.19	5000
10	HLS-5120	.19	5000
<b>▼ 3/8" NPT</b>			
3	H-9203	.25	10,000
6	H-9206	.25	10,000
10	H-9210	.25	10,000

## Tubing

Length	Model number	Internal diameter	External diameter	Max. pressure
ft		in	in	psi
5	T-2560	.152	.25	5000

## Options

### Fittings

194 ▶



Collet-Lok® product line  
Swing clamps  
Work supports  
Linear clamps  
Power sources  
Valves  
Pallet components  
System components



## High-pressure filters

- Keep your hydraulic system clean
- Pleated stainless steel wire mesh screen construction provides large filter area in a compact size
- Rated for full system pressure up to 5000 psi
- Bi-directional design allows filtration of oil in either flow direction
- Two piece body construction for easy replacement of filter elements
- High flow rates are obtainable with a minimum pressure drop
- Threaded port connections on each end simplify installation

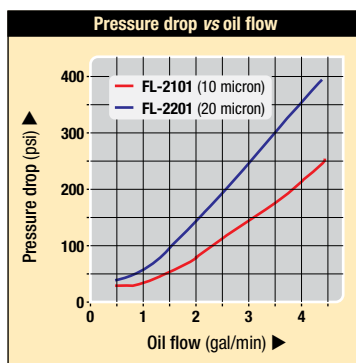
## Hydraulic oil

- Ensures effective lubricity
- Protects essential parts

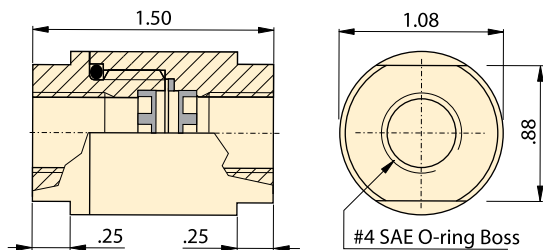
## Filtration

**20 micron filter** provides the longest service life before element replacement

**10 micron filter** recommended for more sensitive hydraulic components



### FL series



## High in line pressure filters

Model number	Filtration		Filter element set	lbs
	Nominal	Absolute		
FL-2101	10	25	FL-2101K	.4
FL-2201	20	40	FL-2201K	.4

## Hydraulic oil

Contents	Model number	Specifications	
		genuine Enerpac hydraulic oil	
Gal			
.25	HF-100	0 °F	<12,000 S.U.S
1	HF-101	100 °F	150/165 S.U.S
5	HF-102	210 °F	42/45 S.U.S
55	HF-104	Flash, C.O.C.	400°F
		Pour point	-25°F
		Aniline point	210/220 °F

Note: Viscosity index: 100 min

www.enerpacwh.com

- E** Mangueras, Filtros Acoplamientos, Aceite
- F** Flexibles, Filtres Raccords, Huile
- D** Schläuche, Filter Kupplungen, Öl

## High-pressure filters

Compact in line high pressure filters prevent chips and debris that have entered the hydraulic fluid system from damaging hydraulic system components.

## Hydraulic oil

Use only genuine Enerpac hydraulic oil to guarantee optimal performance and long life of your hydraulic equipment.

## Options

### Fittings

 194



## Important

**Do not exceed the maximum pressure.**

Hydraulic power is distributed by manifolds and transported by hoses and tubing.



Shown: FZ-2052, FZ-2054, FZ-2023



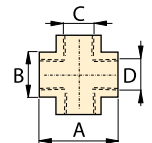
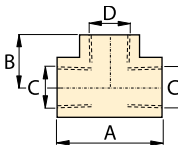
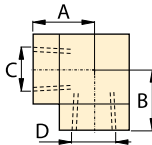
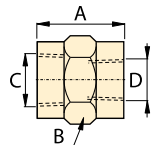
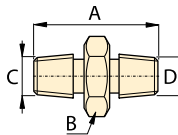
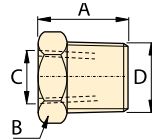
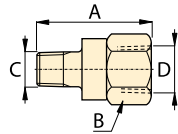
**Fitting** are used to connect all cylinders, components, power sources, tubes, gauges and hoses in a hydraulic system. Enerpac fittings provide flexible, safe and leak-free connections.

## Proper connection for hydraulic components

- Male and female NPT, SAE, BSPP threaded fittings in common sizes allow easy connection of all components.
- BFZ and FZ-1000 models are 10,000 psi maximum pressure
- FZ-2000 models are 5000 psi maximum pressure

## Product selection

From	To	Max. pressure psi	Model number	Dimensions in inches			
				A	B	C	D
<b>▼ Adapters</b>							
<b>Female Male</b>							
1/4" NPT	1/8" NPT	10,000	<b>FZ-1642</b>	1.21	3/4"	1/8"-27 NPT	1/4"-18 NPT
3/8" NPT	1/4" NPT	10,000	<b>FZ-1055</b>	1.44	7/8"	1/4"-18 NPT	3/8"-18 NPT
1/2" NPT	1/4" NPT	10,000	<b>FZ-1633</b>	1.69	1-1/8"	1/4"-18 NPT	1/2"-14 NPT
1/2" NPT	3/8" NPT	10,000	<b>FZ-1634</b>	1.69	1-1/8"	3/8"-18 NPT	1/2"-14 NPT
<b>▼ Reducers</b>							
<b>Female Male</b>							
1/4" NPT	3/8" NPT	10,000	<b>FZ-1630</b>	.86	3/4"	1/4"-18 NPT	3/8"-18 NPT
1/4" NPT	1/2" NPT	10,000	<b>FZ-1661</b>	1.11	7/8"	1/4"-18 NPT	1/2"-14 NPT
SAE #6	SAE #8	5000	<b>FZ-2029</b>	1.38	1-1/16"	9/16"-18	3/4"-16
<b>▼ NPT Male Nipples</b>							
1/4" NPT	1/4" NPT	10,000	<b>FZ-1608</b>	1.45	5/8"	1/4"-18 NPT	1/4"-18 NPT
3/8" NPT	3/8" NPT	10,000	<b>FZ-1617</b>	1.45	3/4"	3/8"-18 NPT	3/8"-18 NPT
3/8" NPT	3/8" NPT	10,000	<b>FZ-1619</b>	2.00	3/4"	3/8"-18 NPT	3/8"-18 NPT
3/8" NPT	G1/4"	10,000	<b>BFZ-305</b>	1.42	3/4"	3/8"-18 NPT	G1/4"-19
<b>▼ NPT Female Connectors</b>							
1/4" NPT	1/4" NPT	10,000	<b>FZ-1605</b>	1.13	3/4"	1/4"-18 NPT	1/4"-18 NPT
3/8" NPT	1/4" NPT	10,000	<b>FZ-1615</b>	1.13	7/8"	3/8"-18 NPT	1/4"-18 NPT
3/8" NPT	3/8" NPT	10,000	<b>FZ-1614</b>	1.13	7/8"	3/8"-18 NPT	3/8"-18 NPT
1/2" NPT	3/8" NPT	10,000	<b>FZ-1625</b>	1.50	1-1/8"	1/2"-14 NPT	3/8"-18 NPT
<b>▼ NPT Elbows</b>							
1/4" NPT	1/4" NPT	10,000	<b>FZ-1638</b>	.88	3/4"	1/4"-18 NPT	1/4"-18 NPT
3/8" NPT	3/8" NPT	10,000	<b>FZ-1610</b>	1.02	7/8"	3/8"-18 NPT	3/8"-18 NPT
<b>▼ NPT Tee</b>							
1/4" NPT	1/4" NPT	10,000	<b>FZ-1637</b>	1.76	3/4"	1/4"-18 NPT	1/4"-18 NPT
3/8" NPT	3/8" NPT	10,000	<b>FZ-1612</b>	2.04	7/8"	3/8"-18 NPT	3/8"-18 NPT
<b>▼ NPT Cross</b>							
3/8" NPT	3/8" NPT	10,000	<b>FZ-1613</b>	2.04	7/8"	3/8"-18 NPT	3/8"-18 NPT



Multiple hydraulic line connections are easily installed with Enerpac fittings and manifolds.



Collet-Lok® product line  
 Swing clamps  
 Work supports  
 Linear clamps  
 Power sources  
 Valves  
 Pallet components  
 System components

99-038

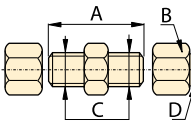
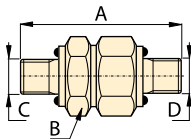
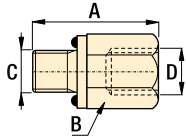
99-119

 **Product selection**

From	To	Max. pressure psi	Model number	Dimensions in inches			
				A	B	C	D

▼ **Adapters**

Male	Female	Max. pressure psi	Model number	A	B	C	D
1/8" NPT	SAE #4	5000	FZ-2075	1.21	11/16"	1/8"-27 NPT	1/4"-18 NPT
1/4" NPT	SAE #4	5000	FZ-2042	1.31	11/16"	1/4"-18 NPT	7/16"-20
1/4" NPT	G1/4"	10,000	BFZ-16411	1.38	3/4"	1/4"-18 NPT	G1/4"
SAE #4	1/8" NPT	5000	FZ-2008	1.00	9/16"	7/16"-20	1/8"-27 NPT
SAE #4	1/4" NPT	5000	FZ-2007	1.16	3/4"	7/16"-20	1/4"-18 NPT
SAE #2	SAE #4	5000	FZ-2022	1.03	11/16"	5/16"-24	7/16"-20
SAE #6	1/4" NPT	5000	FZ-2056	1.16	3/4"	9/16"-18	1/4"-18 NPT
SAE #8	1/4" NPT	5000	FZ-2067	1.13	7/8"	3/4"-16	1/4"-18 NPT
SAE #8	3/8" NPT	5000	FZ-2069	1.28	7/8"	3/4"-16	3/8"-18 NPT
G 1/8"	1/8" NPT	5000	FZ-2055	.97	5/8"	G 1/8"-28	1/8"-27 NPT
G 1/8"	1/4" NPT	5000	FZ-2060	1.28	3/4"	G 1/8"-28	1/4"-18 NPT
G 1/8"	#4 SAE	5000	FZ-2066	1.00	11/16"	G 1/8"-28	7/16"-20
G 1/4"	1/4" NPT	5000	FZ-2023	1.28	3/4"	G 1/4"-19	1/4"-18 NPT
G 1/4"	#4 SAE	5000	FZ-2065	1.11	3/4"	G 1/4"-19	7/16"-20



▼ **Straight union**

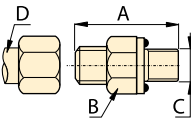
SAE #4	SAE #4	5000	FZ-2005	1.27	9/16"	7/16"-20	7/16"-20
SAE #6	SAE #6	5000	FZ-2028	1.41	11/16"	9/16"-18	9/16"-18
SAE #8	SAE #8	5000	FZ-2040	1.56	7/8"	3/4"-16	3/4"-16

▼ **Straight union to tube ends**

ø.25	ø.25	5000	FZ-2033*	1.38	1/2"	7/16"-20	ø.25
ø.25	ø.25	5000	FZ-2013**	2.03	1/2"	7/16"-20	ø.25

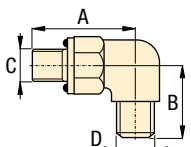
▼ **Adaptors to tube end**

Male	Tube size	Max. pressure psi	Model number	A	B	C	D
1/8" NPT	ø.25	5000	R-1054*	1.22	1/2"	1/8"-27 NPT	ø.25
1/4" NPT	ø.25	5000	FZ-2020*	1.42	9/16"	1/4"-18 NPT	ø.25
1/4" NPT	ø.375	5000	FZ-2072*	1.43	5/8"	1/4"-18 NPT	ø.375
1/4" NPT	ø.25	5000	FZ-2012**	1.32	9/16"	1/4"-18 NPT	ø.25
3/8" NPT	ø.25	5000	FZ-2061*	1.44	3/4"	3/8"-18 NPT	ø.25
3/8" NPT	ø.375	5000	FZ-2068*	1.44	3/4"	3/8"-18 NPT	ø.375
SAE #2	ø.25	5000	FZ-2025*	1.02	9/16"	5/16"-24	ø.25
SAE #4	ø.25	5000	FZ-2019*	1.23	9/16"	7/16"-20	ø.25
SAE #4	ø.25	5000	FZ-2001**	1.13	9/16"	7/16"-20	ø.25
SAE #6	ø.25	5000	FZ-2059*	1.28	11/16"	9/16"-18	ø.25
SAE #8	ø.25	5000	FZ-2039*	1.38	7/8"	3/4"-16	ø.25
SAE #8	ø.375	5000	FZ-2070*	1.38	7/8"	3/4"-16	ø.375
G1/8"	ø.25	5000	FZ-2053*	1.18	14 mm	G1/8"-28	ø.25
G1/4"	ø.25	5000	FZ-2054*	1.37	19 mm	G1/4"-19	ø.25
G1/4"	ø.375	5000	FZ-2064*	1.38	19 mm	G1/4"-19	ø.375






▼ **Elbow to tube end**

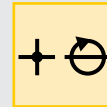
Male	Tube size	Max. pressure psi	Model number	A	B	C	D
1/8" NPT	ø.25	5000	FZ-2074*	0.78	7/16"	1/8"-27 NPT	ø.25
1/4" NPT	ø.25	5000	FZ-2073*	1.09	9/16"	1/4"-18 NPT	ø.25
1/4" NPT	ø.25	5000	FZ-2076**	1.09	9/16"	1/4"-18 NPT	ø.25
1/4" NPT	ø.375	5000	FZ-2081*	1.09	9/16"	1/4"-18 NPT	ø.375
3/8" NPT	ø.25	5000	FZ-2082*	1.22	3/4"	3/8"-18 NPT	ø.25
3/8" NPT	ø.375	5000	FZ-2083*	1.22	3/4"	3/8"-18 NPT	ø.375
SAE #2	ø.25	5000	FZ-2024*	0.92	7/16"	5/16"-24	ø.25
SAE #4	ø.25	5000	FZ-2035*	1.03	9/16"	7/16"-20	ø.25
SAE #4	ø.25	5000	FZ-2002**	1.03	9/16"	7/16"-20	ø.25
SAE #8	ø.375	5000	FZ-2071*	1.45	7/8"	3/4"-16	ø.375
G1/8"	ø.25	5000	FZ-2051*	1.03	14mm	G1/8"-28	ø.25
G1/4"	ø.25	5000	FZ-2052*	1.25	19mm	G1/4"-19	ø.25
ø.25	ø.25	5000	FZ-2014**	0.89	9/16"	ø.25	ø.25



\*Flared  
\*\*Flareless


Pressure: 0-10,000 psi  
Threads: NPT, SAE, BSPP  
For tubing: .25 in/.375 in/8mm

-  Acoplamiento
-  Raccords
-  Verschraubungen




 **Options**

**Gauges**



190 ▶

**Manifolds, couplers, hoses, tubing**



192 ▶

 **Important**

**Do not exceed the maximum pressure.**

**Use fittings and tubing in high cycle applications and areas having excessive heat or weld splatter.**

**To seal NPT threads use anaerobic thread sealers or Teflon paste. Apply Teflon tape one thread from the end of the fitting, to prevent it from winding up in the hydraulic system.**

High pressure hydraulic fittings allow connection of many components with minimum effort.



Pressure: 0-5000 psi

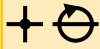
Threads: NPT, SAE, BSPP

For tubing: .25 in/.375 in/8mm

**E** Acoplamientos

**F** Raccords

**D** Verschraubungen



## Options

Manifolds, couplers, hoses, tubing

192 ▶



## Important

Do not exceed maximum pressure.

Use fittings and tubing in high cycle applications and areas having excessive heat or weld splatter.

High pressure fittings enable the design of hydraulic systems to meet a variety of applications.



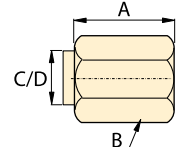
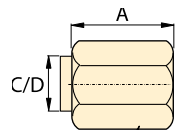
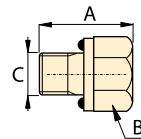
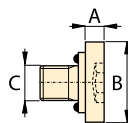
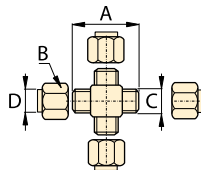
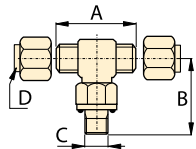
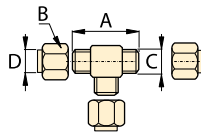
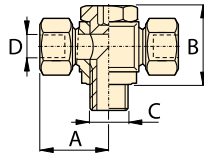
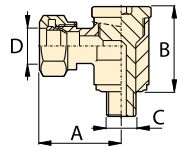
99-080

## Product selection

From	To	Max. pressure psi	Model number	Dimensions in inches			
				A	B	C	D
<b>▼ Swivel banjo BSPP to tube</b>							
<b>Male Tube size</b>							
G1/4"	ø 8mm	10,000	<b>BFZ-307**</b>	1.14	19mm	G1/4"-19	ø 8mm
<b>▼ Swivel T-banjo BSPP to tube</b>							
<b>Male Tube size</b>							
G 1/4"	ø 8mm	10,000	<b>BFZ-309**</b>	1.14	19mm	G 1/4"-19	ø 8mm
<b>▼ Union tee</b>							
ø.25	ø.25	5000	<b>FZ-2021*</b>	1.78	9/16"	7/16"-20	ø.25
ø.25	ø.25	5000	<b>FZ-2015**</b>	1.78	9/16"	7/16"-20	ø.25
<b>▼ Branch tee</b>							
<b>Male Tube size</b>							
SAE #4	ø.25	5000	<b>FZ-2036*</b>	1.78	9/16"	7/16"-20	ø.25
SAE #4	ø.25	5000	<b>FZ-2004**</b>	1.78	9/16"	7/16"-20	ø.25
<b>▼ Union cross</b>							
ø.25	ø.25	5000	<b>FZ-2034*</b>	1.78	9/16"	7/16"-20	ø.25
ø.25	ø.25	5000	<b>FZ-2016**</b>	1.78	9/16"	7/16"-20	ø.25
<b>▼ SAE Plug</b>							
SAE #4		5000	<b>FZ-2006</b>	.11	.56	7/16"-20	
SAE #6		5000	<b>FZ-2003</b>	.19	.69	9/16"-18	
<b>▼ SAE Hex Plug</b>							
SAE #8		5000	<b>FZ-2041</b>	.80	7/8"	3/4"-16	
<b>▼ Nut and Sleeve for Tubing</b>							
ø.25		5000	<b>FZ-2037*</b>	.62	9/16"	37°	ø.25
<b>▼ Cap for Tubing</b>							
ø.25		5000	<b>FZ-2038*</b>	.62	9/16"	37°	ø.25
ø.25		5000	<b>FZ-2017**</b>	.60	9/16"		ø.25
ø.375		5000	<b>FZ-2011*</b>	.73	11/16"	37°	ø.375

\*Flared

\*\*Flareless





## Enerpac “Yellow Pages” stand for Hydraulic Information!

If selecting hydraulic equipment is not your daily routine, then you will appreciate these pages. The “Yellow Pages” are designed to help you work with hydraulics. They will help you better understand the basics of hydraulic system set-ups and the most commonly used hydraulic techniques. By making an educated selection of equipment, you will receive greater benefits from your hydraulic system.

Take the time to go through these “Yellow Pages” and you will benefit even more from Enerpac hydraulic workholding.

### Index

▼ page

Safety instructions	198 - 199
Basic hydraulics	200 - 201
Basic system set-up	202 - 205
Clamping technology	206 - 209
Cutting tool technology	210 - 212
Conversion factors and hydraulic symbols	213 - 219
Valving technology	220 - 223
 Flexible machining systems	224 - 225
Converting from mechanical clamping to hydraulic clamping	226 - 228



### ENERPAC WARRANTY STATEMENT

[www.enerpac.com](http://www.enerpac.com)

Visit our website for the complete Enerpac Global Warranty or call your Enerpac representative or Enerpac Authorized Service Center.

Enerpac is certified for several quality standards. These standards require compliance with standards for management, administration, product development and manufacturing.



Enerpac worked hard to earn the quality rating ISO 9001, in its ongoing pursuit of excellence.

### UL approved

All electrical components used on Enerpac products carry the UL rating when possible.

### Canadian Standards Association



Where specified, Enerpac electric pump assemblies meet the design, assembly and test requirements of the Canadian Standards Association.

### Product Design Criteria

All hydraulic components are designed and tested to be safe for use at maximum 350 bar/5,000 psi pressure unless otherwise specifically noted.

### EMC Directive 89/336/EEC

Where specified, Enerpac electric power pumps meet the requirements for Electromagnetic Compatibility per EMC Directive 89/336/EEC.

### CE Marking & Conformity



Enerpac provides a Declaration of Conformity and CE marking for products that conform with the European Community Directives.



Hydraulic clamping can increase your machine shop's efficiency by reducing setup time. Power clamping can also maximize output by reducing employee lost time due to the injuries that can occur with manual clamping.

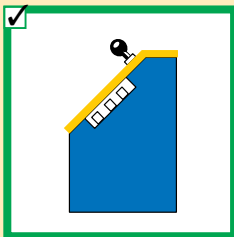
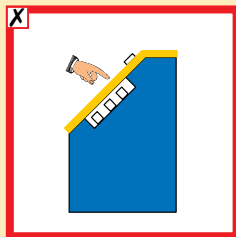
Although hydraulic operation moves the control of the clamping fixture to an area of greater safety, operators must still be alert to several common sense practices. And to that end we offer some DOs and DON'Ts, simple common sense points which apply to all Enerpac hydraulic products.

The line drawings and application photos of Enerpac products throughout this catalog are used to portray how some of our customers have used hydraulics in industry. In designing similar systems, care must be taken to select the proper components that provide safe operation and fit your needs.

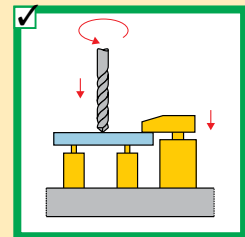
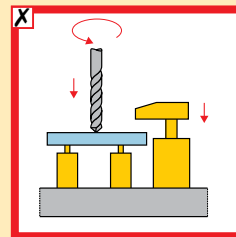
Check to see if all safety measures have been taken to avoid the risk of injury and property damage from your application or system.

Enerpac can not be held responsible for damage or injury, caused by unsafe use, maintenance or application of its products. Please contact the Enerpac office or a representative for guidance when you are in doubt as to the proper safety precautions to be taken in designing and setting up your particular system.

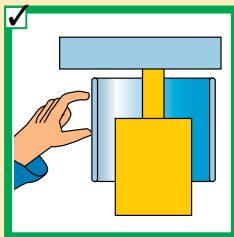
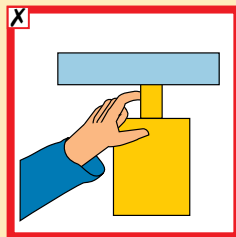
In addition to these tips, every Enerpac product comes with instructions spelling out specific safety information. Please read them carefully.



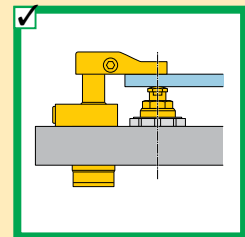
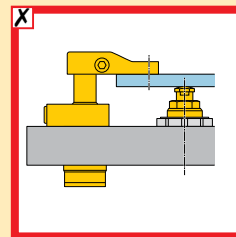
Prevent inadvertent activation of the control units of power operated clamping systems.



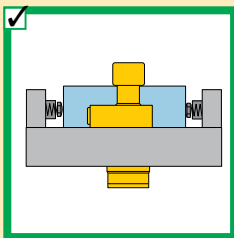
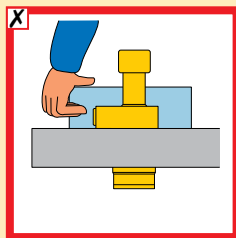
Clamping devices must be activated before main spindle can be started.



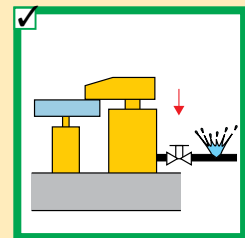
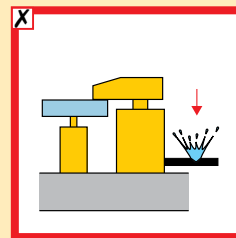
Maintain a safe distance from clamping elements and workpiece to avoid personal injury.



Do not apply off-center load. Clamping force must be directly over the support point.

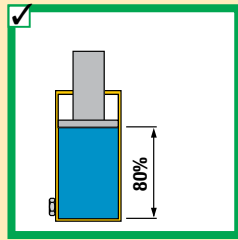
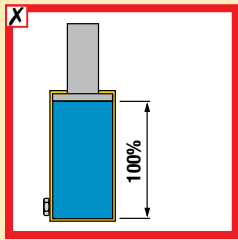


Use mechanical devices and not fingers to hold part until the hydraulics are activated.

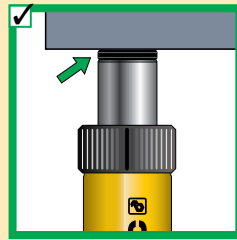
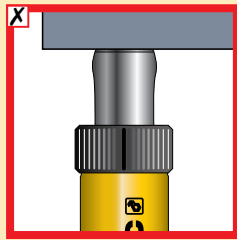


Use check valves to maintain hydraulic pressure to clamping devices in the event of a hydraulic line failure.

Collet-Lok® product line  
Swing clamps  
Work supports  
Linear clamps  
Power sources  
Valves  
Pallet Components  
System components  
Yellow Pages



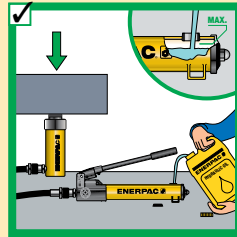
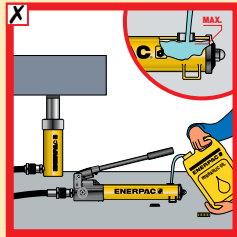
Do not operate cylinders beyond limits of rated stroke or pressure. Use only 80% of usable stroke.



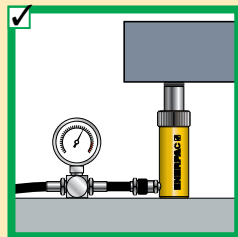
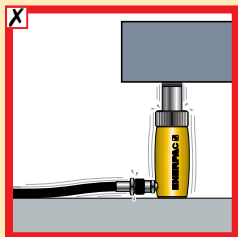
Use saddles or buttons to prevent mushrooming of plungers. Saddles distribute load evenly on the plunger.



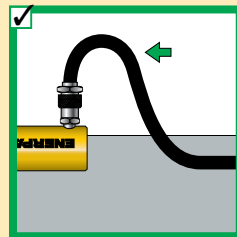
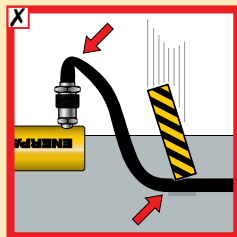
Keep hydraulic equipment away from open fire and temperatures above 150 °F / 65 °C.



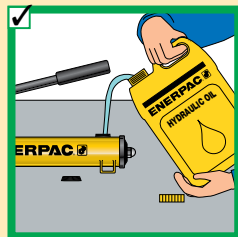
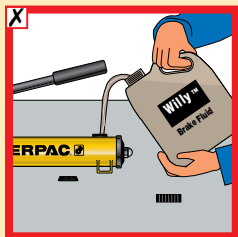
Fill pump only to recommended level. Fill only when connected cylinders are fully retracted.



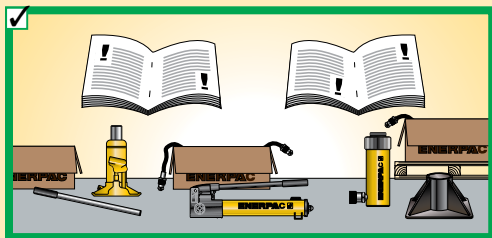
Do not override the factory setting of pressure relief valves. Always use a gauge to check system pressure.



Do not kink hoses. Bending radius must be at least 4.5 inch (115 mm). Do not drive over or drop heavy objects on hoses. Use high pressure tubing in high cycle applications.



Always use genuine Enerpac hydraulic oil.

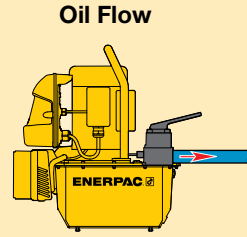


Always read instructions and safety warnings that come with your Enerpac hydraulic equipment.

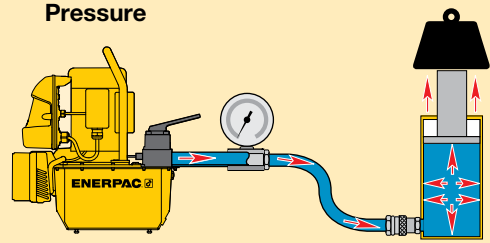


## Oil Flow

A hydraulic pump produces flow. Flow is the amount of fluid coming out of the pump.



## Pressure



## Pressure

Pressure occurs when there is resistance to flow.

## Pascal's Law

Pressure applied at any point upon a confined liquid is transmitted undiminished in all directions (Fig.1). This means that when more than one hydraulic cylinder is being used, each cylinder will pull or push at its own rate, depending on the force required to move the load at that point (Fig. 2).

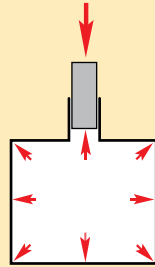
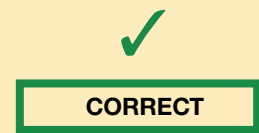


Figure 1



Cylinders with the lightest load will move first and cylinders with the heaviest load will move last (Load A), if the cylinders have the same capacity.

To have all cylinders operate uniformly so that the load is being pulled or pushed at the same rate at each point, control valves (see Valve section) must be added to the system (Load B).

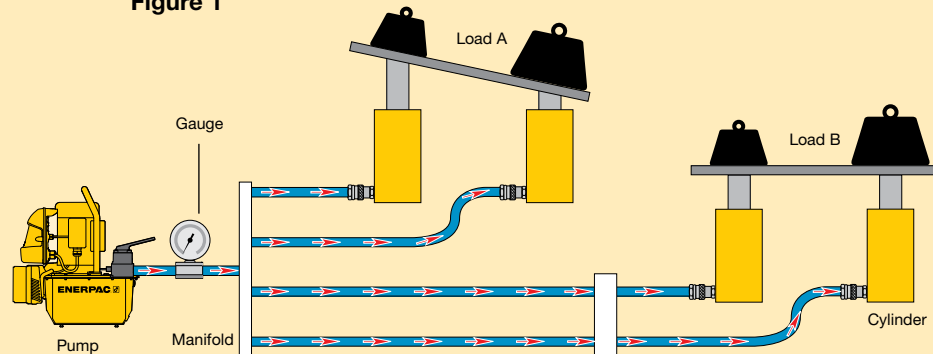


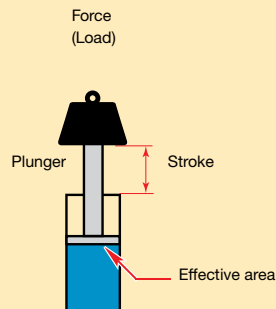
Figure 2

Control valve to provide uniform clamping of the work piece

## Force

The amount of force a hydraulic cylinder can generate is equal to the hydraulic pressure times the "effective area" of the cylinder (see cylinder selection charts).

Use the formula  $F = P \times A$  to determine either force, pressure or effective area if two of the variables are known.



Force	=	Hydraulic Working Pressure	×	Cylinder Effective Area
F	=	P	×	A

Collet-Lok® product line  
Swing clamps  
Work supports  
Linear clamps  
Power sources  
Valves  
Pallet Components  
System components  
Yellow Pages

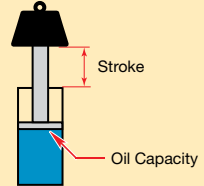




### Cylinder Oil Capacity

The volume of oil required for a cylinder (cylinder oil capacity) is equal to the effective area of the cylinder times the stroke.

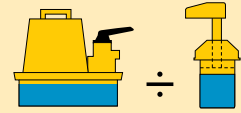
$$\begin{array}{|c|} \hline \text{Cylinder Oil Capacity} \\ \hline \text{in}^3 \\ \text{(cm}^3\text{)} \\ \hline \end{array} = \begin{array}{|c|} \hline \text{Cylinder Effective Area} \\ \hline \text{in}^2 \\ \text{(cm}^2\text{)} \\ \hline \end{array} \times \begin{array}{|c|} \hline \text{Cylinder Stroke} \\ \hline \text{in} \\ \text{(cm)} \\ \hline \end{array}$$



### Usable Oil Capacity

The amount of hydraulic oil in the pump's reservoir which can be used to activate one or more cylinders.

$$\begin{array}{|c|} \hline \text{Pump Usable Oil Capacity} \\ \hline \text{in}^3 \\ \text{(cm}^3\text{)} \\ \hline \end{array} \div \begin{array}{|c|} \hline \text{Cylinder Oil Capacity} \\ \hline \text{in}^3 \\ \text{(cm}^3\text{)} \\ \hline \end{array} = \begin{array}{|c|} \hline \text{Total Number of Cylinders} \\ \hline \end{array}$$



### Cylinder Speed

Pressure applied at any point  
Cylinder speed is determined by dividing the pump flow rate by the cylinder effective area.

$$\begin{array}{|c|} \hline \text{Cylinder Clamp Speed} \\ \hline \text{in/min} \\ \text{(mm/sec)} \\ \hline \end{array} = \frac{\text{Pump Flow Rate in}^3/\text{min (cm}^3/\text{min)}}{\text{Cylinder Effective Area in}^2 \text{(cm}^2\text{)}} \times \frac{10}{60}$$

## Seals

Various seal types are used in our hydraulic equipment: **O-rings, U-cups, Quad-rings and T-rings for static and dynamic applications such as rod-seal, piston-seal and wipers. Buna-N (nitrile rubber) and Polyurethane basic compounds are most frequently used - they offer the best performance and durability for most applications.**

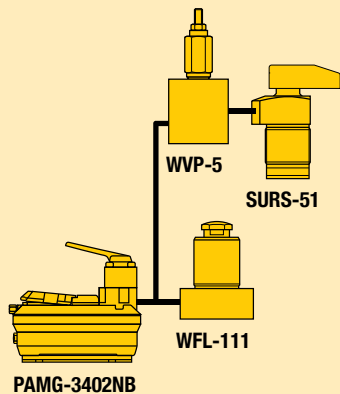
Heat is a crucial factor in seal life. Maximum temperature for good seal life is 150°F (65°C). This is also the maximum temperature of Enerpac hydraulic oil. Above 150°F, the use of Viton and high temperature oil is necessary. Viton has a maximum temperature which is much higher than nitrile or polyurethane. Viton is however an extremely quick wearing material. In many cases Viton seals will have a short working life due to abrasive wear.

Not all machine tool coolants are compatible with standard Enerpac seals. While most are, there are coolants that can harden or soften seals, which may result in free entry of contamination into the hydraulic cylinder. Using a high water based coolant may cause severe corrosive damage. This will often occur on fixtures where coolant has been allowed to pool for an extended period of time and evaporation has allowed it to concentrate. Drain and clean fixtures after use.

Often Viton seals are an immediate cure for coolant attack on standard Enerpac seals. When using Viton seals in cylinders, seals in the power source must also be replaced by Viton because inevitably some coolant will enter the hydraulic system. Consult the coolant manufacturer to verify compatibility with any seal material. Cutting fluid suppliers will provide an application book on the compatibility of their fluids. If problems arise after previous successful use, or if problems persist, contact Enerpac.



Building the right workholding system for a specific production tooling requirement is best achieved by observing the following basic steps – three steps deal with equipment selection, one with system connection.



## Step 1

Selecting the type of cylinders, determined by shape and size of workpiece and the machining process involved, is the critical factor in any workholding system. For that reason, Enerpac offers an exceptionally broad range of production tooling cylinders – in terms of type, stroke and force rating.

**Positioning and push cylinders** are designed to position the workpiece and to push-clamp it securely in that position.

**Down-holding cylinders** are designed to clamp the positioned workpiece firmly to the fixture or worktable. The range of Enerpac swing cylinders and edge-clamps meet virtually any down-holding requirement.

**Pull cylinders** are used where the workpiece shape or fixture dictates clamping by pull forces, this type of cylinder with hydraulic or spring return can be selected to match particular needs.

**Work support cylinders** are designed to maintain the workpiece accurately on the prescribed plane throughout the machining operation. These support cylinders preclude both vibration and distortion problems.

## Step 2

Select cylinder force and stroke, and choose single- or double-acting operation. The choice of force and stroke is largely dependent on size and shape of the workpiece and machining operation involved. Another factor to be considered is working space or clearance around the job, fixture or worktable.

Where a machining operation requires positive hydraulic return action, double-acting cylinders should be specified. Where spring-return action is sufficient, single-acting cylinders or a combination of the two can be used.

## Step 3

Select the power source. The power source for an automatic workholding system can accurately be matched to the requirements. Enerpac pumps span a wide range of sizes and capacities – in compressed air or electric-driven configurations.

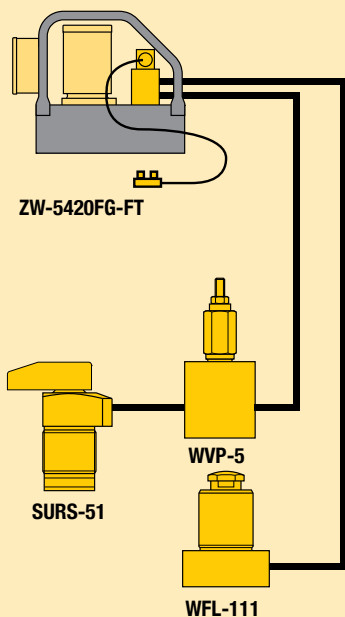
## Step 4

Connect the system. Getting your workholding system together for operation means connecting the pump to the various control valves and cylinders through a circuit of hoses and/or piping, fittings, gauges and other accessories.

For example, two swing cylinders and work support cylinders working in sequence, powered by an electric-drive hydraulic pump unit would require the following components:

1. ZW Workholding pump
2. GA Gauge adaptor
3. G Pressure gauge
4. H Hoses
5. FZ Fittings
6. SU Swing cylinders
7. WFL Work support cylinders
8. WVP-5 Sequence valve

Select all these components from their respective catalog sections.



Collet-Lok® product line  
Swing clamps  
Work supports  
Linear clamps  
Power sources  
Valves  
Pallet Components  
System components  
Yellow Pages



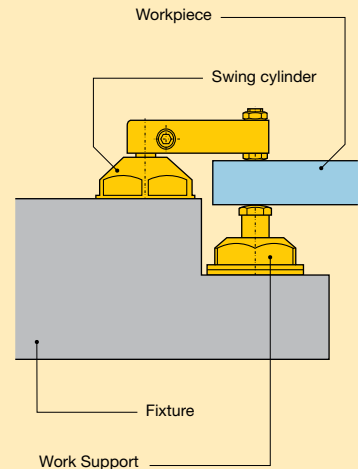
## Swing cylinders and work supports

The combined use of clamping cylinders and work supports in fixturing has become indispensable.

Swing cylinders have become important clamping components for fixturing applications where unrestricted loading and unloading of the workpiece is required. Enerpac offers the most complete, comprehensively featured and compact swing cylinder line.

Work supports are widely used to support critical workpiece areas to prevent them from bending and/or vibrating during the machining process. This minimizes the deflection of the workpiece, improving its quality and assuring a high degree of repeatability.

The combination of swing cylinders and work supports provides substantial time savings and quality improvements in the machine tool industry.



**Figure 1**

The combined use of clamping cylinders and work supports.

## Support forces

When designing a fixture, several products features of swing cylinders and work supports have to be considered. The determination of the necessary support force and the size of the work support is very critical. In principle the work support has to overcome two forces:

- clamping forces
- machining forces (including forces that may be generated by vibrations)

## Clamping forces

In practice, as a rule of thumb, the clamping force applied to the work support should not exceed 50% of its capacity at a given operating pressure. For many applications this is sufficient to absorb additional forces like machining forces. This 2 to 1 safety factor may need to be increased to 4 to 1 if extreme vibration or an interrupted cut is used.

The pressure/force diagrams, provided in the product selection pages of this catalog, allow for quick selection of the right combination of swing cylinder and work support.

The recommended ratio between clamping force and support force can be achieved by selecting the right sizes of the clamping components and/or by operating the swing cylinder and the work support with different operating pressures, e.g. the work support will be operated at maximum pressure while the swing cylinder operates at a reduced pressure.



[www.enerpac.com](http://www.enerpac.com)

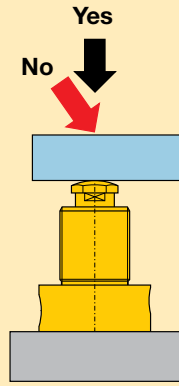
Download the **Swing Clamp Selection Tool**.

The size of the swing cylinder that can be used depends on the required force and length of the clamping arm.

With this tool you can determine, based on above mentioned input and type of clamp, which size of clamp can be used.

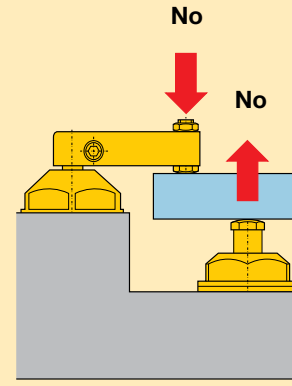


## Point of contact



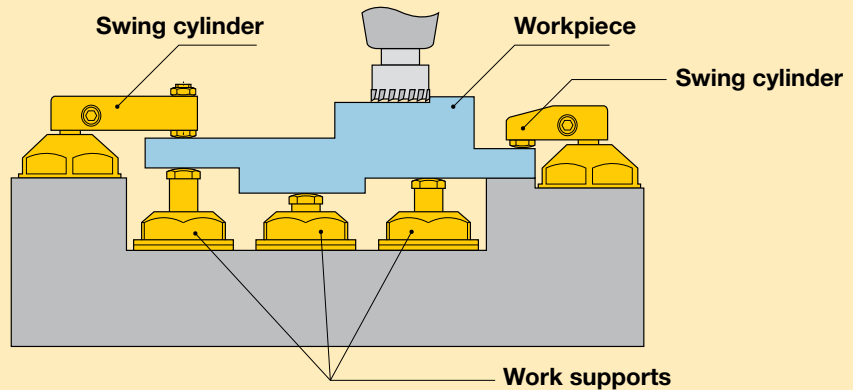
**Figure 2**  
The direction of the clamping force must be axial at the centerline of the work support's plunger for best results in clamping and repeatability of quality.

Side loading of the work support must be avoided in order to ensure reliable and safe function (Figure 2).



**Figure 3**  
An off-set load will cause bending of the workpiece and uncontrolled deflection (Figure 3).

## Hydraulic requirements



**Figure 4**  
Swing cylinders and hydraulically advancing work supports are very sensitive regarding the oil flow rate applied.

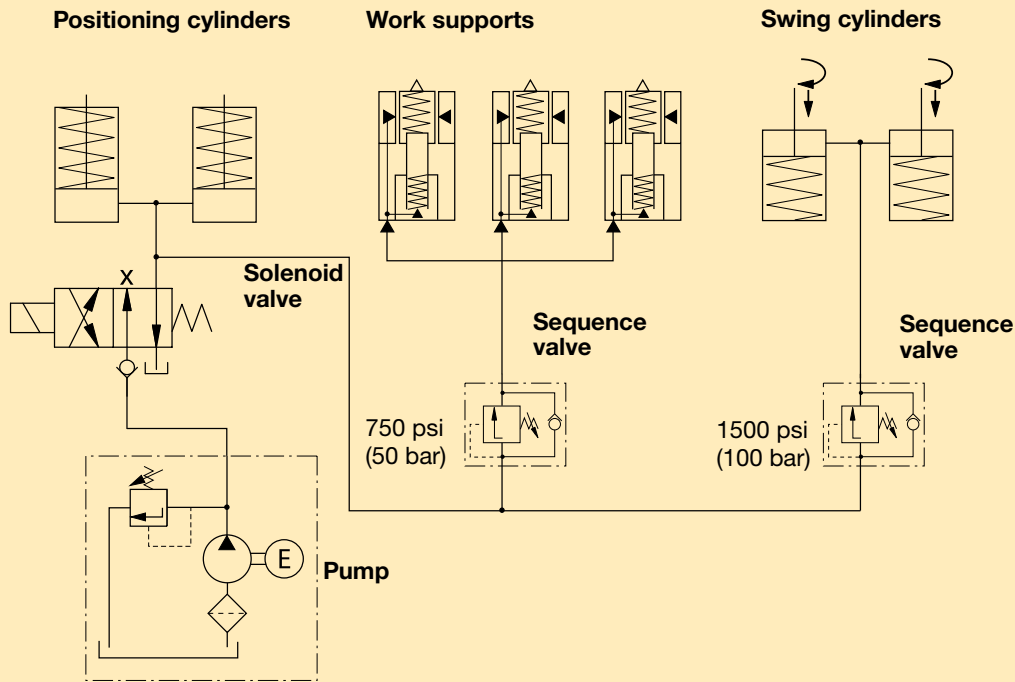
To ensure safe and reliable function of these elements the maximum oil flow rate indicated in the catalog pages and in the instruction literature must not be exceeded. If there is the risk of high oil flow rates it is recommended to use flow control valves to adjust the flow rate.

During the clamping sequence it must be ensured that work supports will be operated only after the workpiece is firmly positioned and held against locators and datums. However, if the cylinder is clamping directly over the work support, the work support should be brought to full pressure before the cylinders clamp. This can be done by using a sequence valve.

Collet-Lok® product line  
Swing clamps  
Work supports  
Linear clamps  
Power sources  
Valves  
Pallet Components  
System components  
Yellow Pages

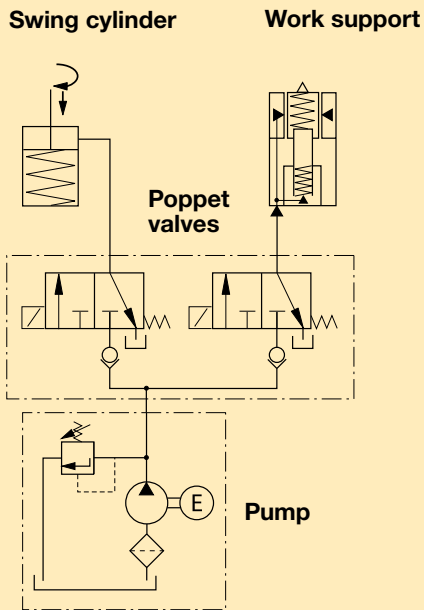


**Hydraulic requirements** (continued)

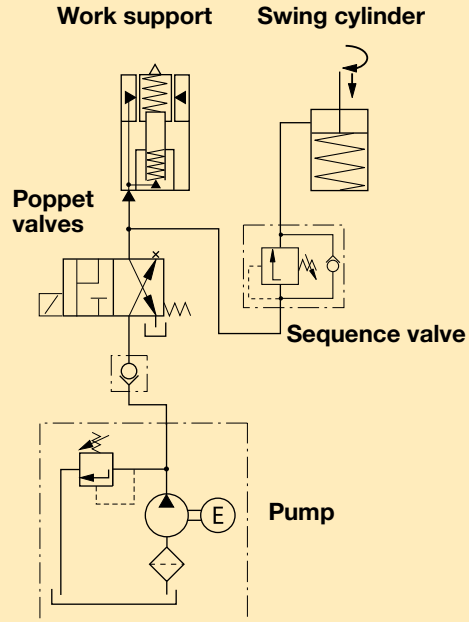


**Figure 5**  
 For overhanging areas of the workpiece which have to be supported, the recommended sequence should be as follows (Figure 5):  
 1. Positioning of the workpiece  
 2. Actuate work supports  
 3. Clamp the overhanging area against work support.

The hydraulic sequence can be controlled either by independently controlled hydraulic circuits (Figure 6) or by sequence valves (Figure 7).



**Figure 6**



**Figure 7**



## 1 Basic principles

1.1 A simple hydraulic clamping mechanism (Figure 1).

### 1.2 Terms and definitions

1.2.1 Clamping Plunger  
A device that applies clamping force to the workpiece.

1.2.2 Workpiece  
The part or material that is to be held in place.

1.2.3 Pressure Piston  
A device used to apply pressure to a hydraulic medium.

1.2.4 Hydraulic Medium  
A fluid used to transmit the pressure created by applying a force to the pressure piston

### 1.3 Hydraulic clamping process

The hydraulic clamping process consists of properly applying the forces created by a hydraulic clamping system to secure a workpiece. A hydraulic clamping system consists of the components illustrated in Figure 1, which shows the basic arrangement and operating principle of the use of hydraulic media.

Any such process using hydraulic fluids for clamping purposes may be referred to as a hydraulic clamping system. The operating pressure provided by hydraulic fluids in clamping systems can reach a maximum of 5000 psi (350 bar), allowing the application of considerable clamping forces even when using compact clamping cylinders.

When properly designed and controlled, the hydraulic clamping mechanism will prevent the workpiece from moving (sliding, twisting, etc.) when machining or other forces are applied, yet will not cause an unexpected permanent distortion to occur in the workpiece.

## 2 Assembly of hydraulic clamping devices

### 2.1 Locating, clamping, and supporting workpieces

#### 2.1.1 Locating a Body

The term “locating” refers to the process of positioning the workpiece inside the clamping device, and holding it in position for the necessary machining. Only workpieces that are correctly held can be consistently machined within specified tolerances.

#### 2.1.2 Limiting the degrees of freedom

The process of locating and holding a workpiece may be referred to as “limiting the degrees of freedom.” Any motion of a workpiece in any possible direction is considered to represent one degree of freedom.

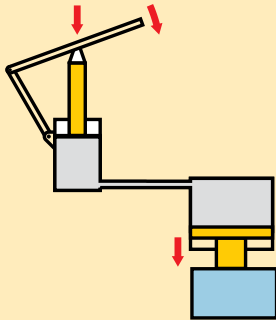
A three-dimensional workpiece therefore possesses six degrees of freedom, as shown in Figure 2. These six degrees of freedom consist of the translational motions “T” in x, y, and z direction, and the rotational motions “R” turning about the x, y, and z axes.

The degrees of freedom that a given workpiece or body possesses may be reduced by introducing reference planes that pass through any two axes.

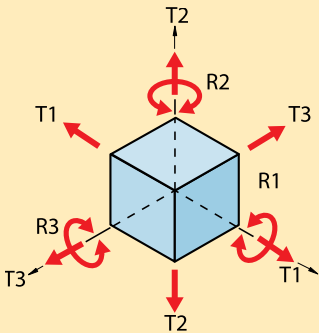
For example, the plane in Figure 3a limits movement to travel in x and z directions and rotation about the y-axis. By defining this fixed plane, the workpiece can thus be limited or constrained to three degrees of freedom.

Another two degrees of freedom may be constrained by introducing a second reference plane, as shown in Figure 3b. This reference plane limits movement to translational motion in the x direction.

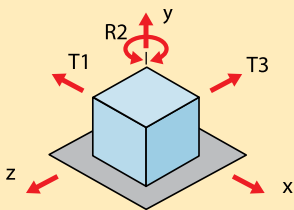
Constraining the last degree of freedom can be accomplished by defining a third reference plane as shown in Figure 3c.



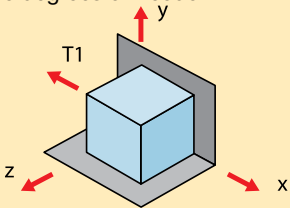
**Figure 1**  
Operating principle of a hydraulic clamping device



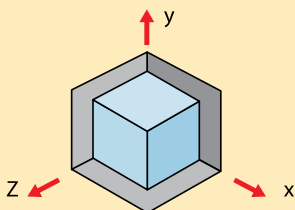
**Figure 2**  
Three-dimensional body



**Figure 3a**  
Three degrees of freedom



**Figure 3b**  
One degree of freedom



**Figure 3c**  
Zero degree of freedom

Collet-Lok® product line  
Swing clamps  
Work supports  
Linear clamps  
Power sources  
Valves  
Pallet Components  
System components  
Yellow Pages

## 2.1.3 Locating a workpiece

The process of locating and holding a necessarily require the elimination of movement in all six degrees of freedom, the following three locating techniques are used in actual practice.

Figure 4a: Semi-constrained Workpiece. The workpiece is held in one plane only (elimination of three degrees of freedom).

Figure 4b: Constrained Workpiece. The workpiece is held by two planes (elimination of five degrees of freedom).

Figure 4c: Fully-constrained Workpiece. The workpiece is held by three planes (elimination of six degrees of freedom).

## 2.1.4 Avoiding over-location

- Workpiece with locating planes
- Incorrectly located workpiece
- Correctly located workpiece

Over-location of the workpiece occurs when there is more than one locating plane or point for any given degree of freedom.

To prevent bending the b-c rib while machining the piece, a third reference plane (3) is introduced. Placing a workpiece (6) inside the clamping device (4) causes over-location. Since the distance between the locating planes (1) and (3) is constant in this device, the dimension c differs between individual workpieces. This over-location therefore gives rise to machining error.

Figure 5c: Shows how to locate a workpiece correctly. To avoid tilting the workpiece, the torque "M" transferred from the workpiece (5) to the body to be machined (6) must be balanced by an appropriate counter-torque. This counter-torque is created by the clamping force "F."

Over-location may also occur if a workpiece (Figure 5) is limited by too many locating points. The introduction of more than three locating points along the bearing surface, or more than two points in the guide plane, or more than one point in the supporting plane may lead to undesirable workpiece motion, and thus adversely affect the precision of the resulting product. Any additional support points must be adjustable.

If the workpiece to be machined must be supported to avoid deflection, then all other bearing points must be defined as variables and must be determined in relationship to the workpiece being machined.

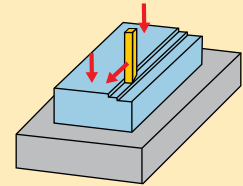
The location process is subject to a number of design guidelines, but exceptions are possible.

- Always arrange the location points according to the pre-machined condition of the workpiece. Previously machined points have priority as desirable locating points.
- The locating points on the locating plane should be as far away from each other as possible.
- Arrange the clamping points such that the defined position is retained during clamping.
- The locating points should be in line with the clamping points to shorten the force vectors inside the workpiece. Three, two, or even one clamping point may be used to clamp a workpiece against the locating plane.
- Precision surfaces should not be held on a continuous surface, so that an "infinite" number of contact points can be avoided.

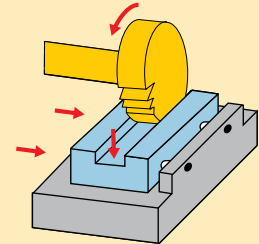
## 3 Clamping

The term "clamping" refers to the secure fastening of an already positioned workpiece in a clamping device for machining purposes. Locating and clamping may be viewed as a combined operation.

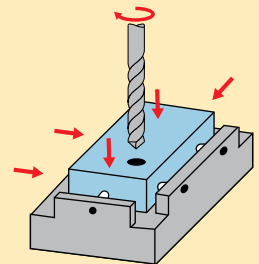
Clamping is invariably associated with force transmission through the device. The force vector should, as far as possible, describe a straight line from the application point of the clamping force through the workpiece to the bearing points.



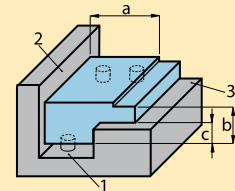
**Figure 4a**  
Semi-constrained Workpiece



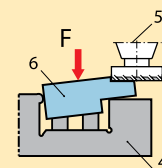
**Figure 4b**  
Constrained Workpiece



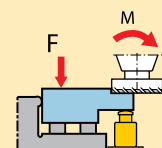
**Figure 4c**  
Fully-constrained Workpiece



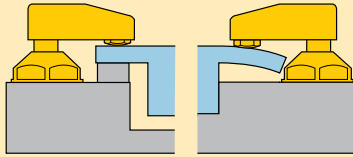
**Figure 5a**  
Workpiece with locating planes



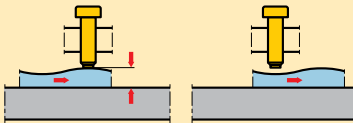
**Figure 5b**  
Inorrectly located workpiece



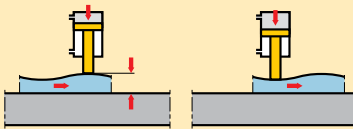
**Figure 5c**  
Correctly located workpiece



**Figure 6**  
Design guidelines for clamping



**Figure 7**  
Mechanical clamping



**Figure 8**  
Hydraulic clamping

As with clamping, locating is subject to a number of design guidelines, although exceptions are possible:

- Keep the clamping force vector away from the critical tolerance zones on the workpiece.
- Workpiece deformation and marking due to clamping forces should be avoided or minimized.
- The clamping points on the workpiece should be selected so that the piece can be machined without reclamping or, if this is not feasible, with a minimum of reclamping.
- The required clamping forces should be approximated by rough estimations.
- The clamping dimensions of the workpiece may change due to thermal expansion and vibration resulting from machining.
- The workpiece should only be exposed to a clamping force if it is appropriately supported by a solid bearing point, as illustrated in Figure 6.

The dimensions of clamped workpieces may change due to vibrations and the effects of thermal expansion. Two types of clamping may compensate for these changes.

- Mechanical Clamping
- Hydraulic Clamping

The illustration in Figure 7 (mechanical clamping) demonstrates that tension is relieved as the dimensions of the workpiece in the clamping area change.

In hydraulic clamping, the clamping elements gripping the workpiece adjust to changes while maintaining a constant clamping force. This is illustrated in Figure 8, where the workpiece is elongated due to temperature increases during machining.

Mechanical clamping is accomplished by using the following mechanical clamping elements:

- Clamping Bars
- Clamping Springs
- Clamping Nuts
- Clamping Bolts (Figure 7)

Hydraulic clamping is achieved by:

- Elastometric media
- Clamping with air (pneumatic clamping)
- Clamping with liquids (hydraulic clamping)

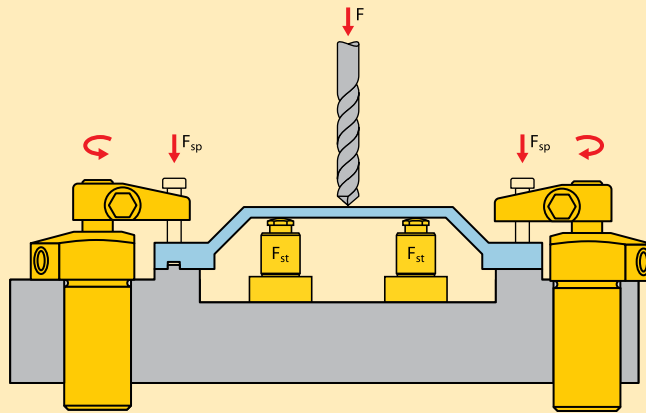
Mechanical clamping elements are usually used for simple clamping devices. However, mechanical clamping elements may be converted to hydraulic ones by inserting cylinders between the clamping element and the workpiece. In addition, mechanical elements may also be combined with hydraulic clamping elements.

Clamping may be subject to errors that cause deformation of the clamped workpiece. Since such deformations must not affect the function of the workpiece, all conceivable locating and supporting techniques, as well as the best possible directed transmission of the clamping force through the workpiece, should be considered.

It is recommended that clamping forces be estimated to prevent excessively high clamping forces and possible deformation of the workpiece. Deformation of the workpiece may also be avoided by selecting a suitable shape (for example, a sphere) for the clamping points and the locating points.

Collet-Lok® product line  
Swing clamps  
Work supports  
Linear clamps  
Power sources  
Valves  
Pallet Components  
System components  
Yellow Pages





**Figure 9**  
Supported workpieces.

## 4 Supporting the workpiece

### 4.1 Supported workpiece

The workpiece requires support to ensure functional force transmission between the tool, the workpiece, and the clamping device, and/or to protect the workpiece from deformation (such as deflection at points with a thin cross-section) due to machining forces, gravitational forces, and clamping forces. Workpiece support also acts to eliminate the resulting machining errors (Figure 9).

In addition, surface quality may be improved and the service life of the tool prolonged with the use of an optimum supporting mechanism. The three-dimensional position of a workpiece, however, should not be defined by its support. It is preceded sequentially by the locating process and also has a lower priority.

### 4.2 Supporting options for bent workpieces

- Unclamped workpiece
- Clamped workpiece
- Machined workpiece

A workpiece is considered to be supported even if it must be supported by frequently mobile and variable elements surpassing the theoretical maximum number of locating points. An example of this would be an unstable workpiece that easily vibrates.

When a deformed workpiece must be held and clamped in all three planes without altering its shape, it is possible to use a technique involving self-adjusting spherical surfaces. In this

case the bearing surfaces, the close-tolerance bolts, the limit stops, and the vertically adjustable supporting and clamping elements must be equipped with spherical surfaces.

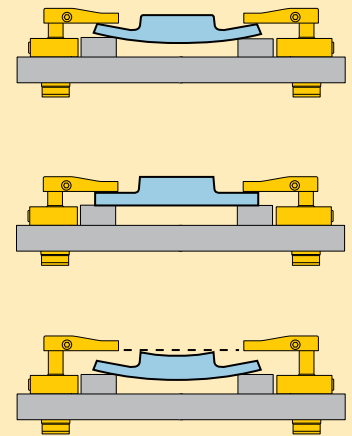
The illustrations in Figure 10 illustrate two different clamping methods. It shows deformation of a workpiece caused by conventional clamping (Figure 10a). As a result of this deformation, the surface area of the workpiece exhibits a greater degree of deformation when unclamped.

This deformation, which is convex in shape, may be attributed to the fact that the workpiece assumes its original, deformed shape (c), as soon as the clamping pressure is released.

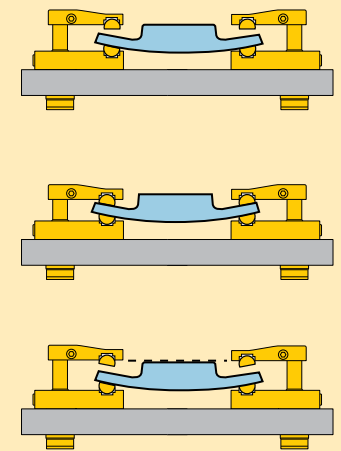
The clamping points illustrated in Figure 10b are spherically shaped, and can therefore largely adapt to the workpiece curvatures (b). The machined surface is therefore flat, and the workpiece is only exposed to possible internal stresses that may be released by machining.

### 4.3 Determination of the clamping force

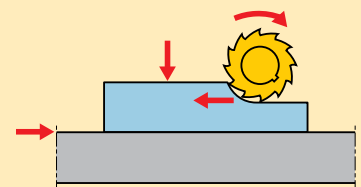
It is important to ensure that a workpiece that is clamped inside a device is not moved from its position by the clamping force and the subsequent action of the cutting force. This risk of movement may be minimized by applying the clamping force to the solid bearing surfaces of the device (Figure 11).



**Figure 10a**  
Deformation caused by conventional clamping



**Figure 10b**  
Eliminate deformation using spherical ball supports



**Figure 11**  
Approximation of the clamping force



Collet-Lok®  
Product line

Swing clamps

Work supports

Linear clamps

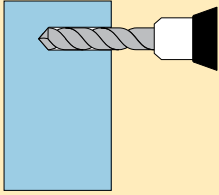
Power sources

Valves

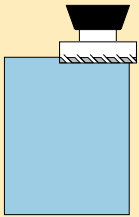
Pallet Components

System components

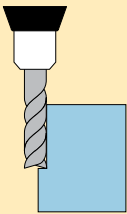
Yellow Pages



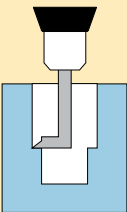
Drilling



Face milling



End mill



Boring

## Introduction

**This introduction will help you use information provided by tool manufacturers in the application of their tools. Estimating cutting forces being transferred into the workpiece is just one tool to use in a competitive workholding environment.**

The information presented here is only to be a guideline and not the final decision. Use this information with a cutting tool brochure you get from your cutting tool supplier as an aid in determining your cutting forces. Much of the calculations presented here are readily available from many sources. Your cutting supplier may even have a slide chart you can obtain to do equations for you.

The operations described here include boring, drilling, end milling and face milling.

**Drilling** involves using a multi-fluted tool with a helix spiral. The tool is driven in as it is rotated to create a round hole.

**End Milling** uses a multi-fluted rotary tool with or without removable (inserts) teeth to remove material along the edge of the workpiece. The cut is usually very shallow and the depth is many times the thickness of the cut.

**Face Milling** involves a very shallow depth, but a very wide cut. Cutters can range up to 12 inches (300 mm) or more in diameter and can have many replaceable teeth (inserts).

These examples are only a very small sample of operations that can use hydraulic workholding.

## Cutting force determinations

These cutting force examples involve face milling. The largest use of hydraulic workholding is by far for some sort of milling operations.

### 1 Imperial system

Cutting Force (Pounds) = Spindle Horsepower x 26400 (Horsepower to foot pounds per minute at 80% efficiency) / Cutting Speed (In tool surface feet per minute) Spindle Horsepower = Unit Power (Horsepower per cubic inches of material removed per minute) x Material removal rate (Cubic Inches per Minute)

Material removal rate (Cubic inches per minute) = Width of the cut (Inches) x Depth of the Cut (Inches) x Feed per cutter tooth (Inches) x Number of cutter teeth x Spindle RPM

#### Example

An 8-inch diameter cutter with 10 teeth (inserts) is machining low silicon aluminum at 3000 SFM (surface feet per minute).

First, you must convert surface feet/minute into tool RPM/Solving Tool RPM= SFM

Diameter (Inch) x .2618 = 1432 Tool RPM

Now you can determine your material removal rate. An independent tool catalog lists a feed per tooth of 0.008" maximum at 3000 SFM at cut depth of 0.1"

This gives 8" (diameter cutter) x 0.100" (cut depth) x 0.008" (feed per tooth) x 10 (number of teeth) x 1432 (spindle RPM)= 91.6 cubic inches per minute material removal rate.

Next, spindle horsepower is found using unit HP from the table Spindle Horsepower = 91.6 x 0.4 (Unit Horsepower for Aluminum with a dull tool) = 36.6 HP.

Note this Horsepower is for fixture design and not for machine tool horsepower requirements.

For example a true 40 HP machine can remove aluminum well over 200 cubic inches per minute.

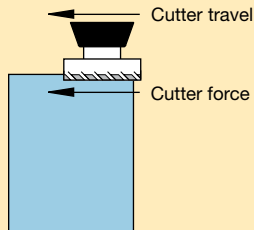


Using the original formula:

$36.6 \text{ hp} \times 26,400/3000 \text{ SFM} = 322 \text{ lbs.}$   
3000 SFM of force being transmitted into the work.

Force is transmitted in the same direction as the cutter movement. In other words, if the cutter moves right to left in the diagram below, the cutter force is transmitted from right to left.

Using a safety factor of 2 for rigid clamping gives 644 pounds in line parallel to the line force and 483 pounds using an elastic medium such as hydraulics with a safety factor of 1.5. Note this force does not take into account any sort of friction factors if you plan on relying on friction force between a swing cylinder and the workpiece.



### For example:

The coefficient of friction for lubricated aluminum is .12 (flooded with coolant) this same 483 pounds of force becomes  $483/.12 = 4025$  pounds. This uses clamp force only and does not take into account any direct forces that may be developed by the cylinders that located the workpiece against fixed locators.

$$\text{Cutting Force}^{[1]} = \frac{\text{Spindle Hp} \times 26406^{[2]}}{\text{Cutting Speed}^{[3]}}$$

[1] Cutting force in Pounds

[2] Spindle Horsepower to foot-pounds at 80% efficiency

[3] Cutting tool surface feet per minute

$$\text{MRR}^{[1]} = W \times D \times F \times N \times \text{RPM}^{[2]}$$

[1] Material Removal Rate (in<sup>3</sup>/min)

[2] W = Width of cut (in)

D = Depth of cut (in)

F = Feed per tooth (in)

N = Number of cutter teeth

RPM = Spindle speed

$$\text{Tool RPM} = \frac{\text{SFM}^{[1]}}{\text{Diameter} \times 0.2618}$$

[1] SFM = Surface Feet per Minute

## Unit Power for dull tools [imperial system]

Material	Hardness	Unit Power hp/in <sup>3</sup> /min		
		Turning HSS & Carbide Tools	Drilling HSS Drills	Milling HSS & Carbide Tools
<b>STEELS</b>	85-200 Bhn	1.4	1.3	1.4
Plain carbon	35-40 Rc	1.7	1.7	1.9
Alloy steels	40-50 Rc	1.9	2.1	2.2
Tool steels	50-55 Rc	2.5	2.6	2.6
	55-58 Rc	4.2	3.2	3.2
<b>CAST IRONS</b>	110-190 Bhn	0.9	1.2	0.8
Gray, ductile and malleable	190-320 Bhn	1.7	2.0	1.4
<b>STAINLESS STEELS</b>	135-275 Bhn	1.6	1.4	1.7
	30-45 Rc	1.7	1.5	1.9
<b>TITANIUM</b>	250-375 Bhn	1.5	1.4	1.4
<b>NICKEL ALLOYS</b>	80-360 Bhn	2.5	2.2	2.4
<b>ALUMINUM ALLOYS</b>	30-150 Bhn	0.3	0.2	0.4
<b>MAGNESIUM ALLOYS</b>	40-90 Bhn	0.3	0.2	0.2
<b>COPPER ALLOYS</b>	10-80 Rb	0.8	0.6	0.8
	80-100 Rb	1.2	1.0	1.2



# Cutting technology

$$\text{Cutting Force} \text{ [1]} = \frac{\text{Spindle kW} \times 48000 \text{ [2]}}{\text{Cutting Speed} \text{ [3]}}$$

[1] Cutting force (N)

[2] Spindle power (kW) required at 80% efficiency

[3] Cutting tool surface speed (m/min)

$$\text{MRR} \text{ [1]} = \frac{W \times D \times F \times N \times \text{RPM} \text{ [2]}}{1000}$$

[1] Material Removal Rate (cm<sup>3</sup>/min)

[2] W = Width of cut (mm)  
D = Depth of cut (mm)  
F = Feed per tooth (mm)  
N = Number of teeth  
RPM = Spindle speed

$$\text{Tool RPM} = \frac{\text{MPM} \times 1000 \text{ [1]}}{\pi \times \text{Tool diameter} \text{ [2]}}$$

[1] MPM = Surface speed m/min

[2] Tool diameter in millimeters

## Metric System

Cutting Force (Newtons) = Spindle Power (kW) x 48000 (80% efficiency) / Cutting Speed (Meters per minute).

Spindle Power = Unit Power (kilowatts per cubic centimeters of material remove per minute) x Material removal rate (cubic centimeters per minute).

Material removal rate (Cubic centimeters per minute) = Width of cut (mm) x depth of cut (mm) x feed per tooth (mm) x number of teeth x spindle RPM/1000.

### Example:

A 200 mm cutter with 10 teeth is machining low silicon aluminum at 1000 MPM (meters per minute).

Solving Tool RPM = MPM x 1000 Diameter (mm) x p (= 1592 Tool RPM)

The same tool catalog lists a feed per tooth of 0.2 mm at 1000 MPM and a cutting depth of 2.5 mm. This gives an 200 mm cutter x 2.5 mm depth x 0.2 mm feed x 10 teeth x 1592 Tool RPM/1000 = 1592 cm<sup>3</sup>/min.

Spindle power = 1592 x 0.018 = 28.7 kW

This too is power from a fixture design standpoint; the actual operation will use less power than indicated here.

Using the original formula transposed is: Cutting Force 1378 (Newtons) = 28.7 (kW) x 48000 (80% efficiency) / 1000 (MPM cutting speed).

Multiply by a safety factor of 2 for rigid clamping and by 1.5 for elastic clamping (hydraulic).

This calculation does not take into account coefficients of friction when using clamp cylinders. For example, if the aluminum has a coefficient of .12 (flooded with coolant), the clamping force becomes 1378/.12 = 11483 Newtons of force. This calculation does not take into account forces being generated by the fixture positioning cylinders.

Use these numbers and set up your hydraulic system to run at about 50 to 75% of its rated pressure. This leaves some reserve for a later date when the process is optimized and you need more holding/ clampforce for higher speeds and feeds. If you design to the maximum now, you have nothing in reserve.

## Unit Power for dull tools [metric system]

Material	Hardness	TURNING P1	DRILLING P	MILLING P d
		HSS AND CARBIDE TOOLS	HSS DRILLS	HSS AND CARBIDE TOOLS
		feed	feed	feed
		.12 - .50 mm/r	.05 - .20 mm/r	.12 - .30 mm/r
<b>STEELS, WROUGHT</b>				
<b>AND CAST</b>	85-200 Bhn	0.064	0.059	0.064
Plain Carbon	35-40 Rc	.077	.077	.086
Alloy Steels	40-50 Rc	.086	.096	.100
Tool Steels	50-55 Rc	.114	.118	.118
	55-58 Rc	.191	.146	.146
<b>CAST IRONS</b>	110-190 Bhn	.41	.055	.036
Gray, ductile and malleable	190-320 Bhn	.077	.091	.064
<b>STAINLESS STEELS,</b>				
<b>WROUGHT AND CAST</b>	135-275 Bhn	.073	.064	.077
Ferritic, austenitic and martensitic 30-45 Rc	.077	.068	.086	
<b>TITANIUM</b>	250-375 Bhn	.068	.064	.064
<b>NICKEL ALLOYS</b>	80-360 Bhn	.114	.100	.109
<b>ALUMINUM ALLOYS</b>	30-150	.014	.009	.018
<b>MAGNESIUM ALLOYS</b>	40-90	.009	.009	.009
<b>COPPER ALLOYS</b>	10-80 Rb	.036	.027	.036
	80-100 Rb	.055	.046	.055

Collet-Lok® product line  
Swing clamps  
Work supports  
Linear clamps  
Power sources  
Valves  
Pallet Components  
System components  
Yellow Pages





The following information consists of recommendations, advice and general rules regarding the design of hydraulic workholding systems. These tips apply to just about any system, and are a good starting point if you have questions about what products to use and how to apply them properly.

## General design

Double-acting cylinders should always be used in applications where cycle time is critical. While the cylinders are designed with strong return springs, they may not consistently overcome the effects of long runs of tubing, orifices, and other restrictions. Double-acting cylinders help eliminate these effects.

Many hydraulic pumps are rated for substantial flow rates (10 gpm or more) that are far beyond the requirements of a hydraulic workholding system. While these pumps can be used, it is not recommended in general practice. Workholding cylinders are typically very small in comparison to the types of cylinders that these pumps were designed to operate. You will spend a great deal of time and money reducing the flow through the use of valving and still may not have an ideal system. Consider a separate hydraulic pump rated for less flow whenever possible.

Spool valves are very common and inexpensive, but also have their share of issues regarding use in hydraulic workholding systems. Spool valves are designed for use at much higher flow rates than those typically seen in workholding circuits. In fact the acceptable internal leakage in these valves is typically equal to the total amount of flow required for a small workholding circuit. And, the leakage will result in improper function and possible damage to many pumps designed for workholding systems.

Breather vents on cylinders are often overlooked. When you put oil into a single-acting cylinder and it begins to advance, the opposite side of the cylinder is filled with air. This air has to go somewhere. The breather vent provides this path. In turn, when the cylinder is retracting, and oil is leaving the cylinder, a vacuum is created and air needs to re-fill that opposite side of the cylinder. If the breather vent is located in an area that is subject to contamination from coolant, and chips, these items will also get pulled into the cylinder. Make sure the breather vent is plumbed to a clean location at all times.

## Swing cylinders

The swing cylinders turn on a mechanical concept of a ball or a pin riding in a hardened groove. Trying to turn this too fast with a large heavy arm will result in enormous pressure on the ball or the pin, causing damage and eventually failure. A large arm also increases the amount of side load introduced into the cylinder. As the length of the arm increases, the allowable clamp load has to decrease accordingly. Follow the one-second rule: it should take at least one full second for the clamp arm to rotate and engage the part. Anything faster can result in damage.

## Work supports

Work supports are rated based upon a somewhat constant load. Sharp vibrations from an interrupted cut or a large impact load (such as dropping a part on the fixture) will cause the work support to slip. Because of the design, once the work support has been subjected to a high impact load, it may no longer function. Be aware of this fact and limit impact loading wherever possible.

## Manifold mounting

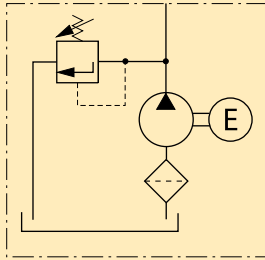
Manifold mounting of cylinders significantly decreases the amount of space required on a fixture. It also makes installation and service much simpler. Be sure to clean and de-burr all passages in the fixture manifold. Burrs can break loose over time and be ingested into the hydraulic cylinders, causing severe damage. If you have a long line of cylinders all in the same manifold, route the passages from the center out and use large diameters for the main feed line. The use of small passages everywhere in the manifold will cause drastic back-pressures on single-acting circuits.

Be sure to include a passage for the breather vents where necessary. This passage should be routed to a large open area, not an enclosed cavity. Eventually, an enclosed cavity may fill up with chips and coolant and begin to work into the cylinders.

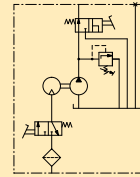
Collet-Lok® product line  
Swing clamps  
Work supports  
Linear clamps  
Power sources  
Valves  
Pallet Components  
System components  
Yellow Pages



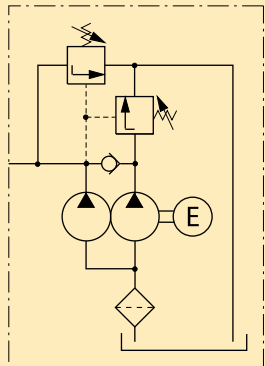
**Power sources**



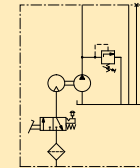
Single-stage electric pump  
Example  
**ZW4010NB-S**



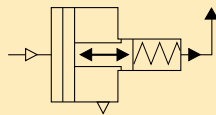
Turbo air pump  
Example  
**PATG-3102NB**



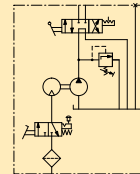
Two-stage electric pump  
Example  
**ZW5020NG**



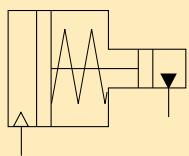
Turbo air pump  
Example  
**PASG-3002SB**



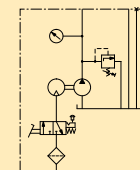
Reciprocating air pump  
Example  
**PA-136**



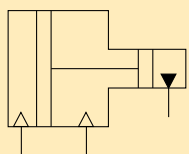
Turbo air pump  
Example  
**PAMG-3402NB**



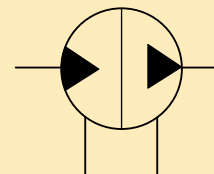
Single-acting booster  
Example  
**B-3006**



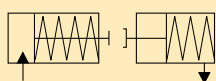
Turbo air pump  
Example  
**PACG-3002NB**



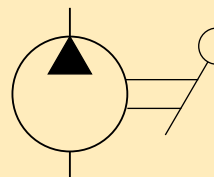
Double-acting booster  
Example  
**AHB-34**



Hydraulic intensifier  
Example  
**PID-321**



Activator wand and booster  
Example  
**B-171**  
**RA-1061**

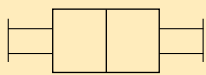


Hand pump  
Example  
**P-142**



## Valves

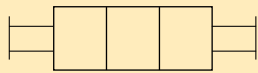
Collet-Lok® product line  
Swing clamps  
Work supports  
Linear clamps  
Power sources  
Valves  
Pallet Components  
System components  
Yellow Pages



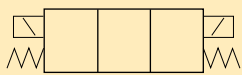
2-position manual



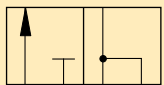
2-position solenoid



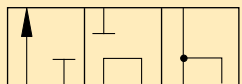
3-position manual



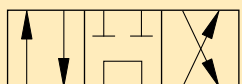
3-position solenoid



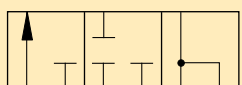
3-way, 2-position, Normally open  
Series **V** Example **VM-2**



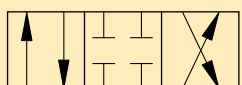
3-way, 3-position, Tandem center  
Series **V** Example **VM-3, VC-3**  
**VE** **VEF-15000D**



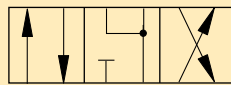
4-way, 3-position, Tandem center  
Series **V** Example **VM-4, VC-4**  
**VE** **VEC-15000D**



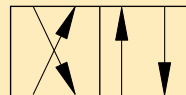
3-way, 3-position, Closed center  
Series **V** Example **VC-15**  
**VE** **VEG-15000A**



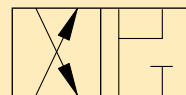
4-way, 3-position, Closed center  
Series **V** Example **VC-20**  
**VE** **VEB-15000A**



4-way, 3-position, Float center  
Series **VE** Example **VED-15000A**  
**VMM** **VMMD-001**



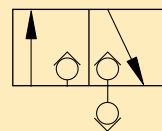
4-way, 2-position, Crossover offset  
Series **VE** Example **VEE-15000A**



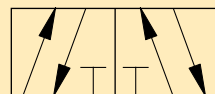
4-way, 2-position, Normally open  
Series **VSS/VAS** Example **VSS-1410D**



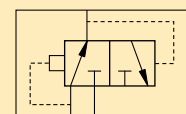
4-way, 2-position, Normally closed  
Series **VST/VAT** Example **VST-1410D**



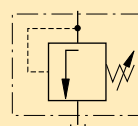
3-way, 2-position, Normally closed  
Series **VP** Example **VP-31**



4-way, 2-position, Air valve  
Series **VA** Example **VA-42**  
**VAS-42**



Rapid air exhaust valve  
Series **VR** Example **VR-3**

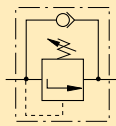


Pressure relief valve  
Series **V** Example **V-152**



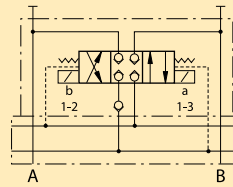


**Valves**

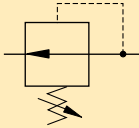


Sequence valve  
Series  
**MVP**  
**WVP**

Example  
**MVPM-5**  
**WVP-5**

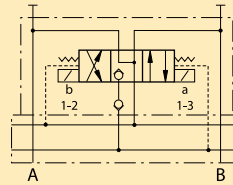


4-way, 3-position, Closed center  
Example  
**VP-11, -12**

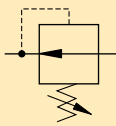


Pressure limiting valve  
Series  
**PLV**

Example  
**PLV-40013B**

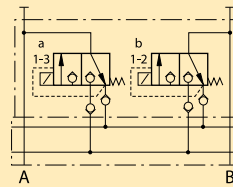


4-way, 3-position, Float center  
Example  
**VP-21, -22**

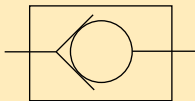


Pressure reducing valve  
Series  
**PRV**

Example  
**PRV-3**

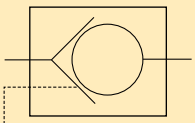


3-way, 2-position, Normally closed  
Example  
**VP-31, -32**



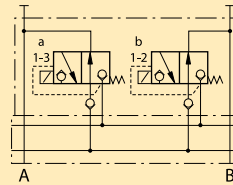
Check valve  
Series  
**V**

Example  
**V-17**

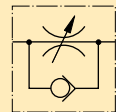


Check valve, Pilot operated  
Series  
**MV**  
**V**

Example  
**MV-72**  
**V-72**

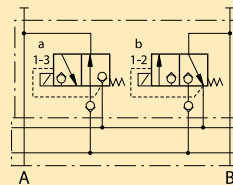


3-way, 2-position, Normally open  
Example  
**VP-41, -42**

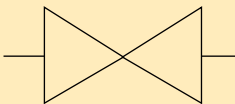


Flow control valve, Free flow check  
Series  
**VFC**

Example  
**VFC-1**

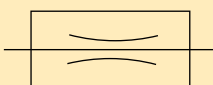


3-way, 2-position,  
one port normally open and  
one port normally closed  
Example  
**VP-51, -52**



Shut-off valve  
Series  
**V**

Example  
**V-12**

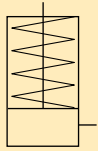


Auto-damper valve  
Series  
**GS, V**

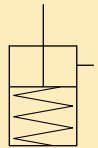
Example  
**GS-2, V-10**



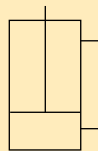
## Cylinders



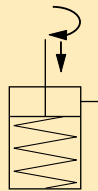
Single-acting cylinder, Push  
Example  
**CSB-18252**  
**CST-5131**  
**CSM-18131**



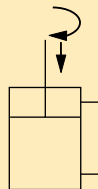
Single-acting cylinder, Pull  
Example  
**PLSS-51**  
**PTSS-51**  
**PUSS-51**



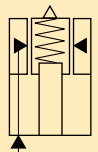
Double-acting cylinder  
Example  
**CDB-18252**  
**RD-96**  
**CDT-18131**



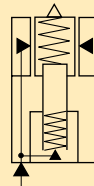
Single-acting swing cylinder  
Example  
**SLRS-92**  
**STRS-92**  
**SURS-92**



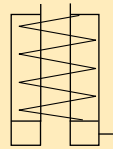
Double-acting swing cylinder  
Example  
**SLRD-92**  
**STRD-92**  
**SURD-92**



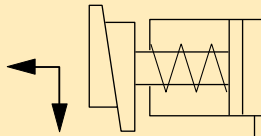
Spring advance work support  
Example  
**WSL-111**



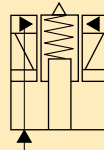
Fluid advance work support  
Example  
**WFL-111**



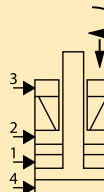
Single-acting hollow plunger cylinder  
Example  
**CY-21295**  
**HCS-80**  
**RWH-202**



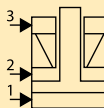
Pull down clamp  
Example  
**ECH-202**



Collet-Lok® work support  
Example  
**WPFS-200**  
**WPTR-200**



Collet-Lok® swing cylinder  
Example  
**WPFR-100**  
**WPTR-100**



Collet-Lok® push cylinder  
Example  
**WPFS-100**  
**WPTR-100**

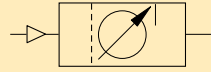
Collet-Lok® product line  
Swing clamps  
Work supports  
Linear clamps  
Power sources  
Valves  
Pallet Components  
System components  
Yellow Pages



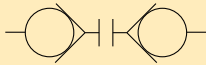
**System components**



Pressure gauges  
Example  
**DGR-1**  
**G-2534R**



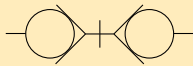
Air regulator  
Example  
**RFL-102**



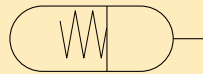
Hydraulic couplers, Uncoupled  
Example  
**AH-650**  
**AH-652**  
**AH-654**



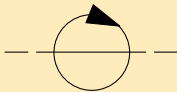
Accumulator, Gas charged  
Example  
**ACL-201**  
**WA-502**



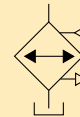
Hydraulic couplers, Coupled  
Example  
**AH-650**  
**AH-652**  
**AH-654**



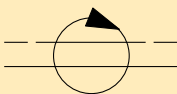
Accumulator, Spring loaded  
Example  
**ACM-1**



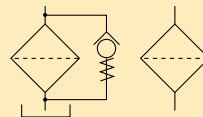
Rotary coupler, Single passage  
Example  
**CR-111**



Heat exchanger  
Example  
**ZHE-1**



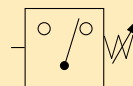
Rotary coupler, Double passage  
Example  
**CRV-221**



Return line filter,  
high pressure filter, in line  
Example  
**PFK-25**  
**FL-2101**



Rotary coupler, Four passage  
Example  
**CRV-441**



Pressure switch  
Example  
**IC-50**



Collet-Lok® product line  
Swing clamps  
Work supports  
Linear clamps  
Power sources  
Valves  
Pallet Components  
System components  
Yellow Pages

## Valve types and functions

Hydraulic valves can be divided into 3 groups:

1. Directional Control
2. Pressure Control
3. Flow Control

### 1 Directional control valves

#### Ways – the (oil) ports on a valve

A 3-way valve has 3 ports: pressure (P), tank (T), and cylinder (A).

A 4-way valve has 4 ports: pressure (P), tank (T), advance (A) and retract (B).

Single-acting cylinders require at least a 3-way valve, and can, under certain instances, be operated with a 4-way valve.

Double-acting cylinders require a 4-way valve, providing control of the flow to each cylinder port.

#### Positions – the number of control points a valve can provide

A 2-position valve has the ability to control only the advance or retraction of the cylinder. To be able to control the cylinder with a hold position, the valve requires a third position.

#### Operation – the way to shift the valve into position

The valve position can be manually operated with the use of the handle.

The valve position can be solenoid operated using power supply.

#### Center configuration

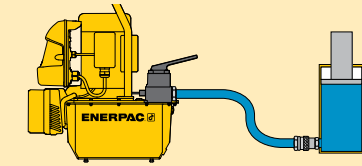
The center position of a valve is the position at which there is no movement required of the hydraulic component, whether a tool or cylinder.

The most common is the **Tandem Center**. This configuration provides for no movement of the cylinder and the unloading of the pump. This provides for minimum heat build-up.

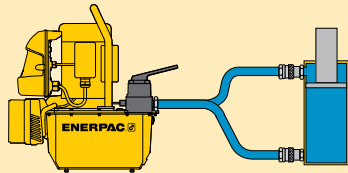
The next most common is the **Closed Center** configuration, which is used mostly for independent control of multi-cylinder applications. This configuration again provides for no movement of the cylinder, but also dead-heads the pump, isolating it from the circuit.

The use of this type of valve requires some means of unloading the pump to prevent heat build-up.

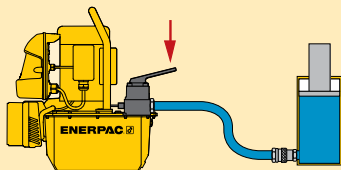
Another commonly used valve configuration is **Float Center**. This type of valve allows the cylinder ports to drain pressure back to tank. Used with a pallet mounted pilot operated check, it allows the hydraulics to be disconnected from the pallet.



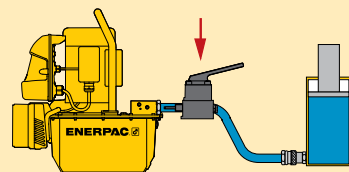
3-way valve used with single-acting cylinder



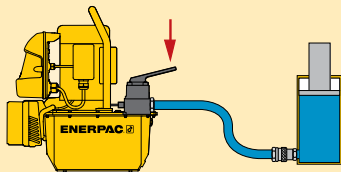
4-way valve used with double-acting cylinder



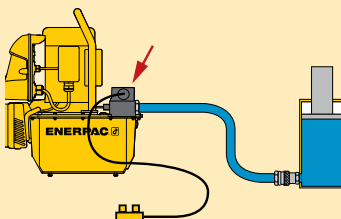
Valves can be pump mounted



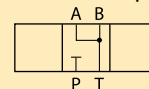
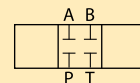
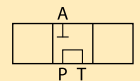
Valves can be remote mounted



Valves can be manually operated



Valves can be solenoid operated



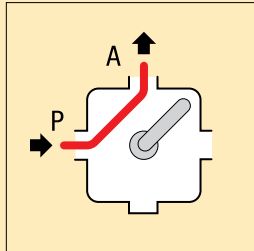


**Advance, hold and retract**

The direction of the oil flow can be controlled depending on valve type, valve positions and port functions.

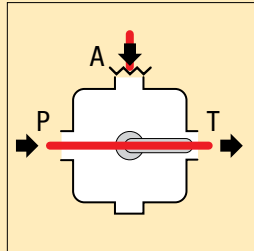
**Single-acting cylinder**

Controlled by a 3-way, 3-position valve.



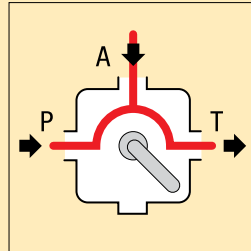
**Advance**

The oil flows from the pump pressure port P to the cylinder port A: the cylinder plunger will extend.



**Hold (tandem center)**

The oil flows from the pump pressure port P to the tank T. The cylinder port A is closed: the cylinder plunger will maintain its position.

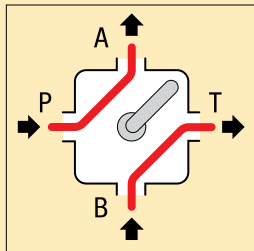


**Retract**

The oil flows from the pump and cylinder port A to the tank T: the cylinder plunger will retract.

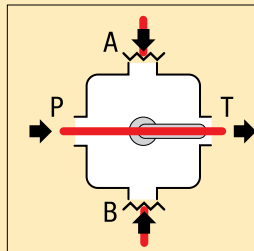
**Double-acting cylinder**

Controlled by a 4-way, 3-position valve.



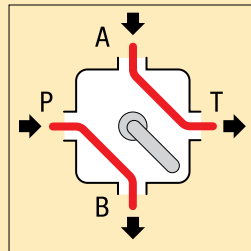
**Advance**

The oil flows from the pump pressure port P to the cylinder port A and from cylinder port B to tank T.



**Hold (tandem center)**

The oil flows from the pump pressure port P to the tank T. The cylinder ports A and B are closed: the cylinder plunger will maintain its position.



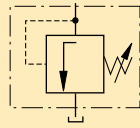
**Retract**

The oil flows from the pump pressure port P to cylinder port B and from cylinder port A to tank T: the cylinder plunger will retract.



## 2 Pressure control

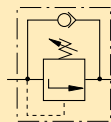
### Relief valve



The most common type of pressure control valve is the pressure relief valve. This valve is used to limit the maximum pressure in the hydraulic circuit. This valve should always be included in any hydraulic system to limit the circuit to a maximum safe pressure. When used in a system, design considerations should be made since the valve does not act instantly. As the pressure approaches the set point the valve will at first only permit a very small amount of oil to pass. It is only when the valve opens farther that the full flow will pass through the valve.

From a practical standpoint, don't set the relief valve with a hand pump and then use it with a power pump and vice versa. The point of operation will vary. Also because of this action, when used in application with a pressure switch, the pressure setting on the pressure switch should be set at least 500 psi (35 bar) lower than the point at which the relief valve opens. This will prevent rapid cycling of the motor on the pump because of the slight pressure loss through the relief valve. If the pressure settings must be closer than that the pressure switch should be monitoring the system pressure and a check valve should be added between the pump and the system. This will permit the pressure to bleed down on the pump through the relief and yet the check holds the pressure in the system, which is monitored by the pressure switch.

### Sequence valve

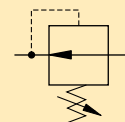


This valve controls the order in which various branches of the hydraulic circuit operate. It sequences the order of the actions. In practice, one part of the circuit will reach a preset pressure at which point the sequence valve will open and permit oil to flow to the secondary part of the circuit. When the flow to the secondary part of the circuit begins, the pressure in the first part of the circuit will remain at the set point permitting for example a work support to stay at its rated pressure as the swing cylinder clamps.

Enerpac sequence valves have a free flow return check meaning that there is no sequence action when the circuit is unclamping. There is however a small bias spring that will open at about 30 psi (2 bar). This will ensure a positive seal when the valve must provide sequence action in the forward direction. When multiple sequence valves are used they should be used in parallel and not in series. If used in series, these 30 psi (2 bar) bias springs will restrict the flow in an accumulative effect.

For example, if three valves are used, there would be about  $3 \times 30 \text{ psi} = 90 \text{ psi}$  (6 bar) of backpressure on components after the sequence valve in the system. While on a 5000 psi (350 bar) system this pressure may not seem like much, it is enough to prevent a single-acting swing from unclamping all the way or possibly cause a work support to not fully release and not properly readjust for the next part.

### Pressure reducing valve

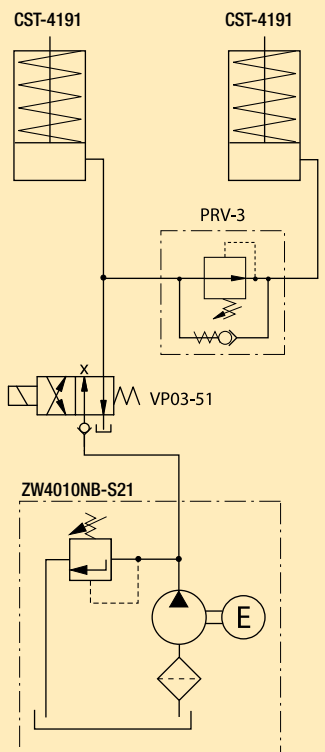
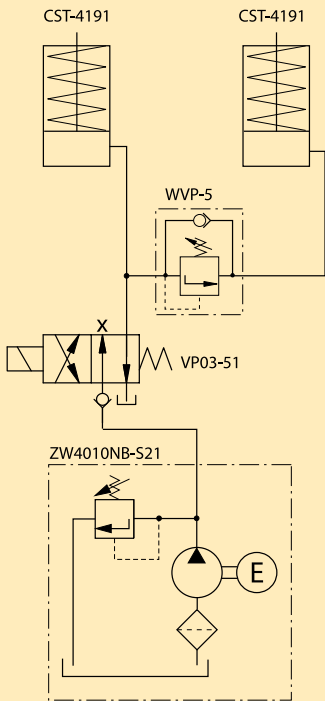


As the name implies, this valve will reduce the pressure to a lower value for a secondary part of the circuit. This is useful, for example,

when you must reduce the capacity of a swing cylinder that might be clamping over a work support. The pressure reducing valve will automatically make-up pressure loss after the valve by permitting a very small amount of oil to the secondary circuit.

This pressure difference from when the valve first closes to the point it re-opens for pressure make-up is referred as the "deadband" of the valve. For example, on the Enerpac pressure reducing valve, this deadband is about 5% of the system pressure. If your system pressure is 3000 psi (210 bar) and the reduced pressure is 2000 psi (140 bar), the pressure in the secondary part of the circuit would need to drop 5% of the system pressure, [ $3000 \times .05 = 150 \text{ psi}$  (10 bar)] before the valve would open.

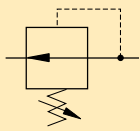
In this case the secondary part of the circuit would drop to 1850 psi (127.5 bar), before the valve would open and permit oil to flow to the secondary part of the circuit to return the pressure to 2000 psi (140 bar). This valve provides this function in only one direction with free flow in the reverse direction to allow cylinders to unclamp or work supports to unlock.



Collet-Lok® product line  
 Swing clamps  
 Work supports  
 Linear clamps  
 Power sources  
 Valves  
 Pallet Components  
 System components  
 Yellow Pages



**Pressure limiting valve**

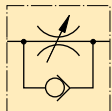


This valve, like the pressure-reducing valve, will limit the pressure in a secondary part of the circuit to a preset lower setting than

the system pressure. This valve functions differently in that once the valve closes, the secondary part of the circuit will not receive any make-up oil for any pressure loss. The system pressure must drop to zero pressure before the valve will open and permit oil to flow to the secondary part of the circuit. There is no pressure make-up capability with a pressure-limiting valve.

**3 Flow control**

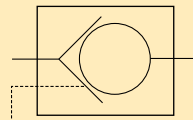
**Flow control valves**



Flow controls permit the change of speed of a hydraulic component through the use of an adjustable orifice. Unlike a regular flow

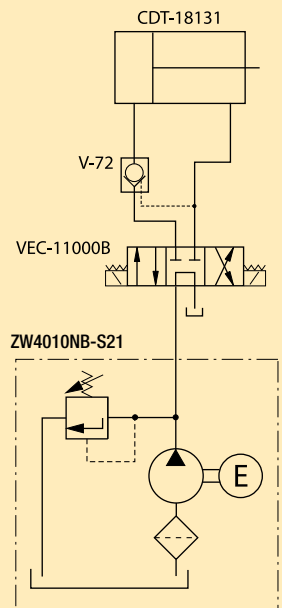
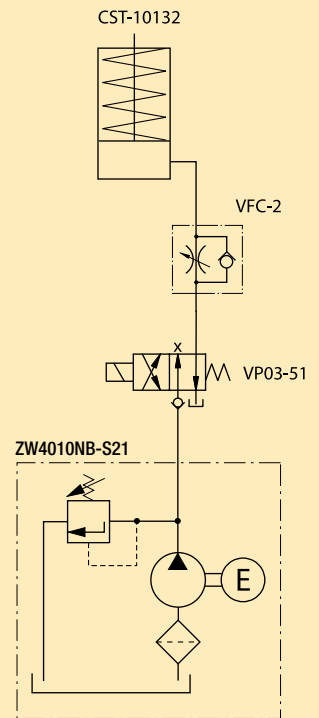
control that provides the same flow restriction in both directions, these flow controls provide a free flow reverse check. This allows restricted flow in one direction and unrestricted flow in the other. This is a very important feature when using a flow control to regulate the speed of a single-acting swing cylinder or work support. The cylinder requires the clamping speed be regulated to a safe value through the use of a flow control to prevent damage to the cylinder. When unclamping, the spring in the cylinder will develop only a small amount of pressure. To ensure rapid unclamp time, back pressure, or resistance, must be minimized. Free flow reverse checks allow you to minimize this resistance.

**Pilot operated check valves**



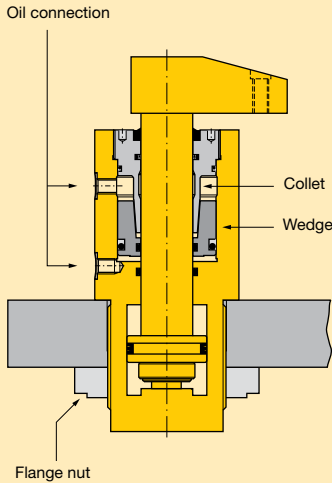
A check valve only permits the flow of oil in one direction. The pilot operated check valve works

the same as a regular check valve but also has an additional port for a pressure signal. Pressure to this extra port will mechanically open the check valve to permit the oil to flow in both directions. The pilot operated check is useful in holding pressure over a period of time in a remote part of a circuit, but allowing the pressure to be released using a pressure signal to the extra port on the valve. Usually this pressure is much lower than the system pressure you are holding back. Enerpac pilot operated check valves only require 15% of the system pressure you are clamping with to open the check valve, permitting the oil to return from the fixture and unclamp the part.





Collet-Lok® product line  
Swing clamps  
Work supports  
Linear clamps  
Power sources  
Valves  
Pallet Components  
System components  
Yellow Pages



**One of the most important aspects of machining cycle times is the speed and precision of the workpiece positioning, clamping and release.**

**The speed of these actions is greatly improved through the use of hydraulic workholding components, leading to increased efficiencies and cost savings.**

#### Use of palletized fixtures

Being able to load many parts onto palletized fixtures also greatly increases the productivity and efficiency of the machining cycle. The use of palletized fixtures poses several problems however. The clamping cylinders must be repeatedly connected and disconnected from the hydraulic power source to make use of the flexibility of the pallets.

With conventional hydraulic cylinders, this also requires the use of load holding valves and accumulators to maintain pressure. With proper maintenance, this system of hydraulic workholding is very effective. This type of clamping is also very susceptible to contamination, and additional care must be taken to maintain the filtration and preventive maintenance schedules required.

■ Fixture for machining exhaust manifolds.



#### Enerpac's exclusive Collet-Lok® technology

There is another solution to palletized clamping. Enerpac's exclusive Collet-Lok® technology eliminates the need for live hydraulics to be maintained on the pallet during the machining cycle. Once the part is hydraulically clamped in position for machining, the cylinders are mechanically locked in place. This mechanical lock replaces the accumulators, load holding valves and other requirements of live hydraulic palletized circuits. Once the machining cycle is complete, the mechanical lock is released, and the cylinders can be retracted to allow for the next piece to be loaded.

Enerpac offers swing cylinders, work supports and push cylinders with Collet-Lok® technology incorporated. Used in conjunction with an automatic coupler, pressure switches and proximity sensors, this technology can provide a totally automated and accurate clamping cycle.

On the next page is an example of how this technology works. The Collet-Lok® swing cylinder has four ports.

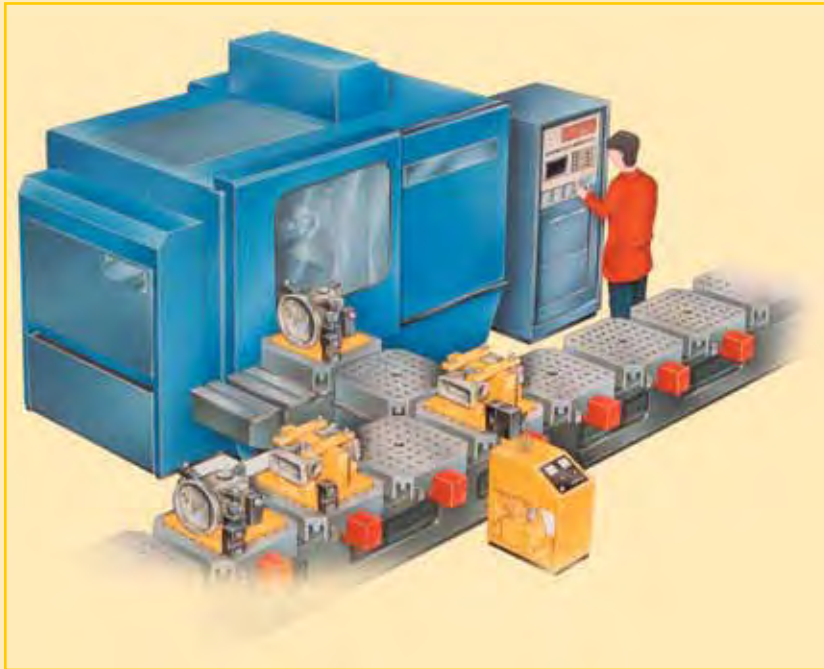
Port #1 is first pressurized to apply the appropriate clamping force. Once this pressure is reached, a sequence valve opens, sending pressure to Port #2, which mechanically locks a wedge into place. This wedge locks the plunger in place, preventing movement, and maintaining the clamping force on the workpiece. The pressure should now be removed and machining can be performed at any time. This lock can be maintained for minutes, hours, even days, without the need for hydraulic pressure.

Once the machining cycle is complete, and the workpiece needs to be changed, the lock can be very easily removed. Pressure should be applied to Port #3 to unlock the wedge system. Once the wedge is unlocked, and the plunger is free, pressure can be applied to Port #4 to allow the plunger to retract. With this complete, the machined workpiece can be removed and a new piece can be loaded into the fixture to continue the process.

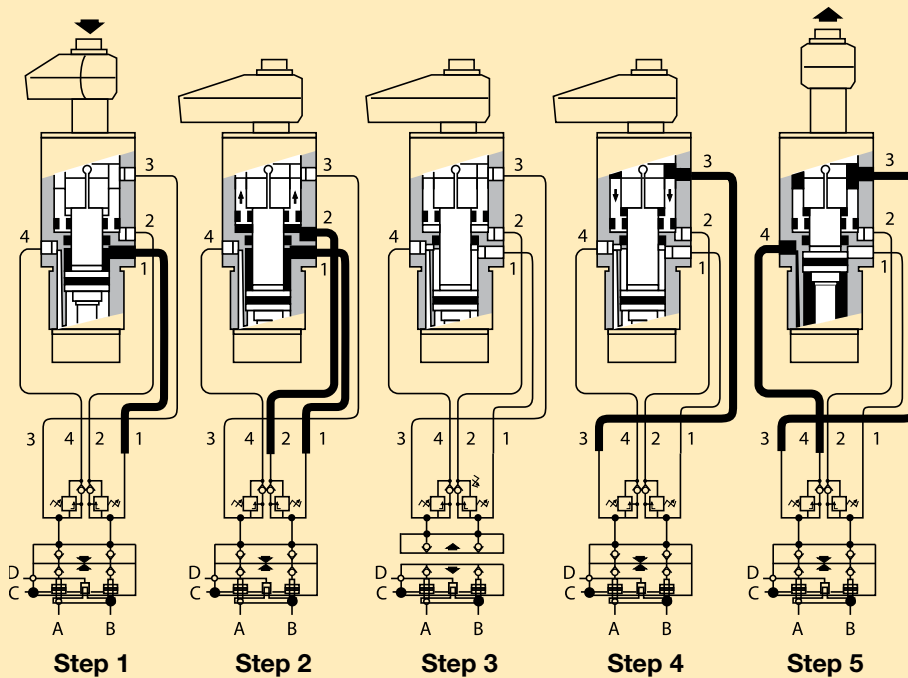
This system is the ultimate in system automation and positive control in clamping technology. For more information, be sure to consult Enerpac to receive additional literature and installation instructions.



## Palletized machining



### Hydraulic Clamping and Hydraulic Mechanical Locking



#### Step 1

2-way Auto coupler connects external power source with pallet part and the Collet-Lok® cylinder is activated for hydraulic clamping.

#### Step 2

After reaching maximum clamping pressure the sequence valve is opened and actuates the internal wedge hydraulically.

#### Step 3

The wedge system secures the plunger position mechanically and the hydraulic pressure is taken off, then the auto coupler retracts. The product on the pallet is now securely clamped, without being connected to a power source.

#### Step 4

After being in the center of the machine the pallet returns to the loading and unloading position and the auto coupler is connected again to release the wedge.

#### Step 5

The hydraulic plunger is now retracted and the pallet is free for unloading and loading.

WPTR-100 Collet-Lok® swing cylinder

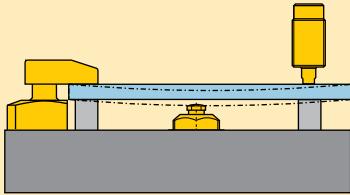
- 1 = 90° Rotation + Clamp
- 2 = Lock
- 3 = Unlock
- 4 = Unclamp + 90° Rotation

WCA-62, WPA-62 Auto coupler

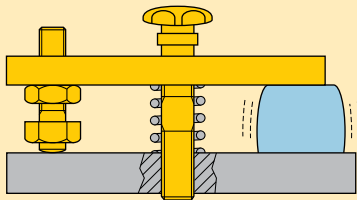
- A = Pressure line from pump to swing cylinder
- B = Pressure line from pump to swing cylinder
- C = Auto coupler advance
- D = Auto coupler retract



Collet-Lok® product line  
Swing clamps  
Work supports  
Linear clamps  
Power sources  
Valves  
Pallet Components  
System components  
Yellow Pages



**Figure 1**  
Simple hydraulic fixture with minimal workpiece deflection



**Figure 2**  
Simple mechanical fixture with larger workpiece deflection

## Mechanical clamping versus hydraulic clamping

Many factors should be taken into account when deciding whether to use mechanical or hydraulic workholding products for clamping your parts. In general, hydraulic clamping should be used in high volume applications, or when critical tolerances need to be held. Mechanical clamping products can be used in shorter production runs, or on rougher procedures where surface finishes and tight tolerances are optional.

For example, using hydraulic workholding products will allow you to maintain within a 1% accuracy on your clamping force. This is through the use of digital pressure switches, electric powered pumps and hydraulic clamping and support cylinders. This type of accuracy may be necessary when machining a surface requiring tight tolerances, less than .001 inch (0,025 mm). The slightest variation in clamping force could result in part movement or deflection greater than the required overall tolerance (Figure 1). In situations like this, the investment in hydraulic clamping is undeniable.

Mechanical clamping products are sufficient when tight tolerances are not required, or when the part is a large casting for example, and no amount of clamping force will distort the part. A typical operator, for example, can tighten a stud over a clamp to a specific torque value with possibly only 10% accuracy using a manual wrench. This could result in significant differences in part height and position on a fixture (Figure 2). However with a rough casting where the required finish is not critical, this may be acceptable. And, for the cost of mechanical clamping compared to hydraulic clamping, the choice is easy.

There are also situations where hydraulic clamping is not only not necessary for accuracy, but also, potentially dangerous. A perfect example of this is a die casting machine. Heat is an enemy of hydraulic components, and die casting obviously generates an enormous amount of heat. Mechanical clamping is an excellent and safe solution to the problem.

Production quantity runs should also be taken into account along with time savings and cost of materials when choosing between hydraulic and mechanical clamping.

Mechanical clamping is typically less expensive but more time consuming compared to hydraulic clamping.

See the examples below for ideal situations in which to use hydraulic or mechanical clamping:

### Example 1

Production quantity:	60,000 pieces
Part material cost:	\$25
Machine time cost:	\$150 p/h
Hydraulic fixture and component cost:	\$30,000
Parts per fixture:	4
Load/unload time:	20 seconds
Run time:	720 seconds

The run time and the load/unload time equate to 185 seconds of machine time per part. The machine costs money no matter whether you are actually cutting chips or waiting to cut chips while you are loading the parts. This is why you must take both the load and the run time into account.

This 185 seconds per part equates to being able to run 155 parts per 8 hour day, at an additional cost of \$7.71 per part due to machine time cost of \$150.00 per hour.

The hydraulic fixture cost of \$30,000 divided over 60,000 parts equates to an additional \$0.50 per part. All together, in this very simple example, you have added only \$8.21 to the cost of the part. The \$8.21 equates to only about a 33% increase in cost. Granted, there are more aspects which could be factored in, but you can see the minimal cost added by hydraulics in this example.

Assume that you were only running 3000 parts on a small run. The machine time is the same, but now, the hydraulic fixture and components adds an additional \$10 to the cost of the part (30,000/3000 parts). This is a total of \$17.71 additional cost, or a 71% increase. Hydraulic clamping is much too expensive for such a short run.



## Example 2

Production quantity:	3000 pieces
Part material cost:	\$25
Machine time cost:	\$150 p/h
Mechanical fixture and component cost:	\$5000
Parts per fixture:	4
Load/unload time:	240 seconds
Run time:	720 seconds

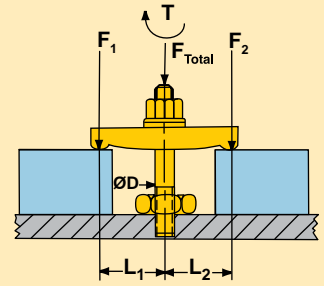
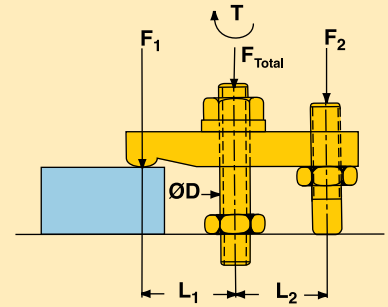
In this example, the production quantity is much lower, and mechanical clamping is being used. The same part is being machined, on the same machine process. The mechanical clamping fixture is much less expensive, only adding \$1.67 to the cost of each part. However, the load/unload time has increased significantly since the operator has to manually clamp each part. The machine is now only able to produce 120 parts per 8 hour day. This adds \$10 to the cost of each part in machine time cost. All together, \$11.67 has been added to the cost of each part, a 47% increase. While this may seem significant, remember that the cost increase using hydraulic clamping was 71%. Mechanical clamping is a much better choice in the lower production runs, even though it may be slower.

Many factors must be taken into account to decide on either mechanical clamping or hydraulic clamping. For example, taking labor into account can significantly add to the cost of mechanical clamping, since it is a much slower process. These examples are very simple and do not include all of the variable details that could affect your decision. Be sure to account for every situation in making your choice.

## Replacing mechanical clamping with hydraulic clamping

In order to properly replace a mechanical clamping set-up with hydraulic cylinders, the most important thing to understand is the amount of clamping force being applied to the part. Figure 3 is an example of a typical mechanical clamping set-up for either one part or two parts. In this situation, the operator tightens the nut on the clamping stud, which in turn applies a holding force to the work piece. In order to convert this set-up to hydraulic clamping, you will need to know some values from Figure 3.

- T** = Torque on the clamping stud (ft-lbs or N-m)
- D** = Thread diameter and pitch (for example, 3/8-16 or M8)
- L<sub>1</sub>** = Distance from center of clamping stud to contact point on the workpiece
- L<sub>2</sub>** = Distance from center of clamping stud to reaction point (or contact point on second workpiece)

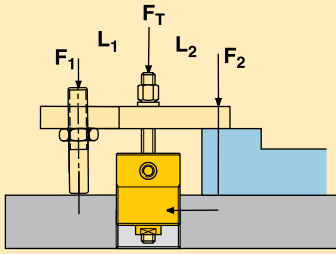


**Figure 3**  
Typical mechanical clamping set-up

You will also need to know whether the clamping stud and nut are lubricated or dry. This makes a difference in how much clamping force is generated.

The first thing to know is how tight that nut is being applied to the clamping stud. This is best measured using a torque wrench. Even though the operator may not use a torque wrench in the everyday use of the fixture, it is critical to be able to provide a torque reading when converting to hydraulic clamping.

It may be necessary to use a torque wrench on the part a few times in order to get a good consistent value to be used in calculating the clamping force.



**Figure 4**  
Center-hole cylinder used in hydraulic clamping set-up

Once you have determined the amount of torque being applied to the clamping stud, and you have measured the diameter of the stud, and the distances  $L_1$  and  $L_2$ , the clamping forces can be calculated. It is important to understand that the amount of clamping force being put into the clamping stud is not the same amount of force being applied to the part. In this setup, much less force gets applied to the part. You can calculate the force applied to the stud using the table. The force applied to the part is based on the formula.

$$F_1 = L_2 / (L_1 + L_2) * F_T$$
$$F_2 = L_1 / (L_1 + L_2) * F_T$$

When  $L_1 = L_2$  (when the clamping stud is exactly halfway between the clamping points),  $F_1 = F_2 = 1/2 F_T$

## SAE stud sizes

Dry Threads K = 0.20		
Stud size	Torque (ft-lbs)	Applied load (lbs)
	4	1190
1/4" - 20	6	1790
	8	2380
	10	2980
	14	3250
5/16" - 18	16	3720
	18	4180
	20	4640
	24	4580
3/8" - 16	28	5350
	32	6110
	36	6880
	60	8470
1/2" - 13	65	9180
	70	9880
	75	10590
	125	13980
5/8" - 11	135	15100
	145	16220
	155	17340
	200	18390
3/4" - 10	225	20690
	250	22990
	275	25280
	350	27390
7/8" - 9	375	29340
	400	31300
	425	33260
	450	30740
1" - 8	550	37580
	650	44410
	750	51240

Lubricated Threads K = 0.15		
Stud size	Torque (ft-lbs)	Applied load (lbs)
	4	1590
1/4" - 20	6	2380
	8	3180
	10	3970
	14	4330
5/16" - 18	16	4950
	18	5570
	20	6190
	24	6110
3/8" - 16	28	7130
	32	8150
	36	9170
	60	11290
1/2" - 13	65	12230
	70	13170
	75	14120
	125	18640
5/8" - 11	135	20130
	145	21620
	155	23120
	200	24520
3/4" - 10	225	27580
	250	30650
	275	33710
	350	36520
7/8" - 9	375	39130
	400	41730
	425	44340
	450	40990
1" - 8	550	50100
	650	59210
	750	68320

**Note:** Values in the charts above are based on theoretical values. The chart values are meant to be guidelines in determining equivalent hydraulic cylinders for an application, but are by no means exact. Factors such as lubrication, material, plating and method or torque application can affect the actual clamping force. Please use proper engineering practices when designing a fixture.

Collet-Lok® product line  
Swing clamps  
Work supports  
Linear clamps  
Power sources  
Valves  
Pallet Components  
System components  
Yellow Pages



**E**NERPAC manufactures high-force hydraulics (cylinders, pumps, valves, presses, pullers, tools, accessories and system components) for industry and construction and provides hydraulic workholding and OEM solutions to industries worldwide.

With an 80-year history of quality and innovation, the broadest line in the business, and more than 4,000 distributors and factory-trained service centers around the world, Enerpac leads the industry by setting new standards in design, strength, durability and local support. Strict quality programs, zero tolerance for defects, and ISO-9001 certification are your assurance of safe, trouble-free operation.

**Enerpac is ready to tackle your toughest challenge and provide the hydraulic advantage you need to increase productivity, labor efficiency and speed of operation.**



## www.enerpac.com for latest Enerpac information

Visit the Enerpac Web Site and find out about:

- Learn more about hydraulics
- Promotions
- New products
- Electronic Catalogs
- Trade shows
- Manuals (instruction and repair sheets)
- Nearest Distributors & Service Centers
- Enerpac products in action
- Integrated Solutions

## Ordering Products and Catalogs

To find the name of the closest Enerpac distributor or service center, to request literature or technical application assistance, contact Enerpac at one of the addresses on the next page or pose your question through E-mail: [info@enerpac.com](mailto:info@enerpac.com)

While every care has been taken in the preparation of this catalog and all data contained within is deemed accurate at the time of printing, Enerpac does reserve the right to make changes to the specifications of any product, or discontinue any product, contained within this catalog without prior notice.

All illustrations, performance specifications, weights and dimensions reflect the nominal values and slight variations may occur due to manufacturing tolerances. Please consult Enerpac if final dimensions are critical. All information in this catalog can be changed due to product improvements without prior notice.

**© Copyright 2013, Enerpac.  
All rights reserved. Any copying or other use of material in this catalog (text, illustrations, drawings, photos) without express written consent is prohibited.**

## Enerpac catalogs/brochures to meet your needs:

To obtain your copy just give us a call, or visit our Internet site [www.enerpac.com](http://www.enerpac.com)

### E327, The Full Enerpac Industrial Tool Line

Ask for your free copy of the Enerpac Industrial Tools catalog for information about Enerpac High Force Tools. The catalog contains our full line of cylinders, pumps, tools, valves, bolting solutions, and accessories.



**E412, Bolting Solutions Catalog:** Caters to the complete bolting workflow, ensuring joint integrity in a variety of applications throughout industry, including: joint assembly, controlled tightening and joint separation.





# What do you think about...

Improved Accuracy? Cost Effective Solutions? Increased Safety?

## Enerpac's On-Line School of Workholding

### Monthly Feature Articles:

- ABC's & 123's of Hydraulic Workholding
- Tool Selection and Usage
- Manufacturing Applications

### Access to Our Library & Archives:

- Product Specifications
- CAD Drawings
- Instruction & Repair Sheets



**PLUS** You will receive: **EU School of Workholding Newsletter** via E-mail free.

Visit **[www.enerpac.com](http://www.enerpac.com)** for more information.

## Workholding CAD files ONLINE!

### TRY IT FOR YOURSELF

Visit **[WWW.Enerpacwh.com](http://WWW.Enerpacwh.com)**

Enerpac is proud to introduce a new way to view Workholding products and download CAD files. From the Enerpac website you are able to quickly locate the right product for your specific application and move to our download site to select from over 2,000 3D CAD files.


The shopping cart format makes downloading multiple files for transfer to your computer fast and easy.

### 3D Formats


- IGES
- STEP

product description	series	page
<b>Collet Lok® clamps</b> <span style="float:right">8-19</span>		
Collet Lok® Swing Clamp Arms.....	CA	14
Collet Lok® Swing Clamps..WPFL, WPPF, WPTL, WPTR .....		12
Collet Lok® Push Cylinders .....	WPFC, WPTC	18
Collete Lok® Work Supports.....	WPFS, WPTS	16
<b>Swing clamps</b> <span style="float:right">20-42</span>		
Pivoting T-Arms.....	CAC/CAPT	34
Swing Clamp Arms .....	CAS/CAL	32
Swing Clamps .....	SC	38
Swing Clamps .....	ASC	39
Swing Clamps, Cartridge Body.....	SC	30
Swing Clamps, Lower Flange.....	SL	26
Swing Clamps, Threaded Body .....	ST	28
Swing Clamps, Upper Flange .....	SU	23
Three-Position Swing Clamp.....	WTR	40
Upreach Arms .....	CAU	36
<b>Work supports</b> <span style="float:right">43-51</span>		
Work Supports, Fluid Advance .....	WF	46
Work Supports, Spring Advance.....	WS	48
<b>Linear cylinders</b> <span style="float:right">52-93</span>		
Cylinder Accessories, Contact Bolts .....	BS	86
Cylinder Accessories, Jam Nuts .....	FN	86
Cylinder Accessories, Mounting Flanges .....	AW/MF	87
Cylinder Accessories, Yoke .....	Y	86
Cylinders, Block .....	CSB/CDB	72
Cylinders, Hollow Plunger..CY/HCS/MRH/QDH/RWH .....		78
Cylinders, Manifold Mount.....	CSM	70
Cylinders, Positive Clamping.....	MRS	80
Cylinders, Pull Down.....	ECH/ECM	76
Cylinders, Threaded Body .....	CST/CDT	66
Cylinders, Threaded Body .....	CYDA/WMT/WRT	68
Cylinders, Tie Rod.....	TR	88
Cylinders, Tie Rod, Accessories..TRRC/TRRE/TRAC .....		93
Cylinders, Universal Single Acting .....	MRW/RW	82
Cylinders, Universal, Double Acting.....	RD	84
Link Clamp Arms.....	LCAS/LCAL	56
Link Clamps, Upper Flange.....	LUCD/LUCS	54
Pull Cylinders, Lower Flange.....	PL	62
Pull Cylinders, Threaded Body.....	PT	64
Pull Cylinders, Upper Flange.....	PU	60
<b>Power sources</b> <span style="float:right">94-133</span>		
Air Hydraulic Boosters.....	AHB/B	105
Air Hydraulic Pump.....	PA	103
Air Powered Pump, Heavy-Duty.....	ZAJ	102
Air Powered Pump, Turbo.....	PAC/PAM/PAR/PAS/PAT	98
Air Valves and Accessories...HV/RFL/QE/V/VAS/VR.....		106
Electric Pumps, Economy .....	WUD	108
Electric Pumps, Submerged .....	WE	110
Hand Pump .....	P, SP	132
ZW Electric Driven Pumps.....	ZW..	114, 128
ZW Pump Filter Kit.....	ZPF	118
ZW Pump Heat Exchanger .....	ZHE	119
ZW Pump Level/Temperature Switch .....	ZLS	120
ZW Pump Mounted Manifolds .....	ZW	121
ZW Pump Pressure Switch/Transducer.....	ZPS/ZPT	120
ZW Pump, Continuous Connection.....	ZW	124
ZW Pump, Pallet Coupling .....	ZW	122
ZW Pump, Single Station .....	ZW	126
<b>Valves</b> <span style="float:right">134-159</span>		
Flow Control for Solenoid Modular Poppet .....	VFC	137
Flow Control, Dual, for D03/CETOP3.....	VFC ..	141,142
Flow Control, Inline.....	VFC	155
Inlet Check Valve, D03/CETOP3 .....	VD1P	140
Manifold, Porting, for Solenoid Modular Poppet...PB .....		139
Manifold, Remote, for D03/CETOP3.....	MB	144
Manifold, Remote, for Solenoid Modular Poppet...WM .....		139


product description	series	page
Manual, D03/CETOP3.....	VMMD/VMTD	143
Manual, Pump Mount .....	VM ..	148-151
Manual, Remote Mount .....	VC ..	148-151
Mounting Bolt Kit for D03/CETOP3 .....	BKD	145
Mounting Bolt Kit for Solenoid Modular Poppet ..	TRK	139
Mounting Bolt Kit for Solenoid Modular .....	BK	147
Pilot Operated Check for Solenoid Modular .....	VS	147
Pilot Operated Check, Dual, for D03/CETOP3... VD2P .....		142
Pilot Operated Check, Inline, Manifold .....	MV, V	153
Pressure Reducing for D03/CETOP3.....	PRV ..	141, 142
Pressure Reducing for Solenoid Modular Poppet...PRV .....		138
Pressure Reducing, Inline, Cartridge.....	PRV	154
Pressure Switch for Solenoid Modular Poppet ...	PSCK	137
Relief Valve for Solenoid Modular .....	VS	147
Sequence, Inline, Manifold, Cartridge...MVP, WVP, V .....		152
Solenoid/ Air Operated 2-Position Poppet, D03/CETOP3 .....	VA, VS	140
Solenoid Modular .....	VE	146
Solenoid Modular Poppet.....	VP	136
Solenoid Poppet, D03/CETOP3.....	VP03	141
Solenoid Spool, D03/CETOP3 .....	VET/VEX/VEW	142
Valve, Accessory .....	V/HV/MHV/PLV ..	156, 157
Valve, Air Valve and Accessories ...RFL/QE/V/VAS/VR .....		158
<b>Palletized fixture components</b> <span style="float:right">160-185</span>		
Accumulators .....	ACM/ACL/WA	162
Autocoupler .....	ACCB/WCA/WPA	174
Coupler Packages.....	ACBS/AP/MHV	164
Intensifiers.....	PID	178
Manual Couplers.....	MC	166
Rotary Unions.....	AMP/CR/CRV	176
Safe Link Wireless Monitoring.....	SL	180
Wand and Booster .....	B/RA	172
<b>System components</b> <span style="float:right">186-196</span>		
Coupler .....	AH/AR	192
Filter, High Pressure, Inline.....	FL	193
Fittings .....	BFZ/FZ/R	194
Gauge, Digital.....	DGR	189
Gauge .....	G	190
Gauge Accessories .....	FM/GA/GS/NV/V	191
Hose.....	H/HLS	192
Manifold, Multiport .....	A	192
Oil, Hydraulic .....	HF	193
Pressure Switch.....	IC/PSCK	188
Pressure Switch Mounting Block .....	PB	188
Tubing .....	T	192
<b>Yellow pages</b> <span style="float:right">197-228</span>		
Basic Hydraulics.....		200-201
Basic System Set-up .....		202-205
Best Practices.....		214
Clamping Technology .....		206-209
Conversion Factors .....		213
Cutting Tool Technology .....		210-212
FMS.....		224
Hydraulic Symbols .....		215
Mechanical Clamping .....		226
Safety Instructions .....		198-199
Valving Technology.....		220




**Collet Lok® Products**  
8-19




**Swing Clamps**  
20-42




**Work Supports**  
43-51




**Linear Cylinders**  
52-93




**Power Sources**  
94-133




**Valves**  
134-159



**Pallet Components**  
160-185



**System Components**  
186-196



**Yellow Pages**  
197-228

Collet-Lok® Products  
Swing Clamps  
Work Supports  
Linear Cylinders  
Power Sources  
Valves  
Pallet Components  
System Components  
Yellow Pages



### Collet Lok® Products

8-19



### Swing Clamps

20-42



### Work Supports

43-51



### Linear Cylinders

52-93



### Power Sources

94-133



### Valves

134-159



### Pallet Components

160-185



### System Components

186-196



### Yellow Pages

197-228

**Australia and New Zealand  
Actuant Australia Ltd.**  
Block V Unit 3  
Regents Park Estate  
391 Park Road  
Regents Park NSW 2143  
(P.O. Box 261) Australia  
T +61 297 438 988  
F +61 297 438 648  
sales-au@enerpac.com

**Brazil**  
Power Packer do Brasil Ltda.  
Rua Luiz Lawrie Reid, 548  
09930-760 - Diadema (SP)-Brasil  
T +55 11 5525 2311  
Toll Free: 0800 891 5770  
vendasbrasil@enerpac.com

**Canada**  
Actuant Canada Corporation  
6615 Ordan Drive, Unit 14-15  
Mississauga, Ontario L5T 1X2  
T +1 905 564 5749  
F +1 905 564 0305  
Toll Free:  
T +1 800 268 4987  
F +1 800 461 2456  
customer.service@actuant.com

**China**  
Actuant (China) Industries Co. Ltd.  
No. 6 Nanjing Road,  
Taicang Economic Dep Zone  
Jiangsu, China  
T +86 0512 5328 7500  
F +86 0512 5335 9690  
Toll Free: +86 400 885 0369  
sales-cn@enerpac.com

**France, Switzerland, North  
Africa and French speaking  
African countries**  
ENERPAC  
Une division d'ACTUANT  
France S.A.S.  
ZA de Courtaboef  
32, avenue de la Baltique  
91140 VILLEBON /YVETTE  
France  
T +33 1 60 13 68 68  
F +33 1 69 20 37 50  
sales-fr@enerpac.com

**Germany and Austria**  
ENERPAC GmbH  
P.O. Box 300113  
D-40401 Düsseldorf  
Willstätterstrasse 13  
D-40549 Düsseldorf, Germany  
T +49 211 471 490  
F +49 211 471 49 28  
sales-de@enerpac.com

**India**  
ENERPAC Hydraulics Pvt. Ltd.  
No. 1A, Peenya Industrial Area  
IIInd Phase, Bangalore, 560 058,  
India  
T +91 80 40 792 777  
F +91 80 40 792 792  
sales-in@enerpac.com

**Italy**  
ENERPAC S.p.A.  
Via Canova 4  
20094 Corsico (Milano)  
T +39 02 4861 111  
F +39 02 4860 1288  
sales-it@enerpac.com

**Japan**  
Applied Power Japan LTD KK  
Besshocho 85-7  
Kita-ku, Saitama-shi 331-0821,  
Japan  
T +81 48 662 4911  
F +81 48 662 4955  
sales-jp@enerpac.com

**Middle East, Egypt and Libya**  
ENERPAC Middle East FZE  
Office 423, LOB 15  
P.O. Box 18004, Jebel Ali,  
Dubai  
United Arab Emirates  
T +971 (0)4 8872686  
F +971 (0)4 8872687  
sales-ua@enerpac.com

**Russia**  
Rep. office Enerpac  
Russian Federation  
Admiral Makarova Street 8  
125212 Moscow, Russia  
T +7 495 98090 91  
F +7 495 98090 92  
sales-ru@enerpac.com

**Southeast Asia, Hong Kong  
and Taiwan**  
Actuant Asia Pte Ltd.  
83 Joo Koon Circle  
Singapore 629109  
T +65 68 63 0611  
F +65 64 84 5669  
Toll Free: +1800 363 7722  
sales-sg@enerpac.com

**South Korea**  
Actuant Korea Ltd.  
3Ba 717, Shihwa Industrial  
Complex  
Jungwang-Dong, Shihung-Shi,  
Kyunggi-Do  
Republic of Korea 429-450  
T +82 31 434 4506  
F +82 31 434 4507  
sales-kr@enerpac.com

**Spain and Portugal**  
ENERPAC SPAIN, S.L.  
Avda. Los Frailes, 40 -  
Nave C & D  
Pol. Ind. Los Frailes  
28814 Daganzo de Arriba  
(Madrid) Spain  
T +34 91 884 86 06  
F +34 91 884 86 11  
sales-es@enerpac.com

**Sweden, Denmark, Norway,  
Finland and Iceland**  
Enerpac Scandinavia AB  
Fabriksgatan 7  
412 50 Gothenburg  
Sweden  
T +46 (0) 31 799 0281  
F +46 (0) 31 799 0010  
scandinavianinquiries@enerpac.com

**The Netherlands, Belgium,  
Luxembourg, Central and  
Eastern Europe, Baltic  
States, Greece, Turkey and  
CIS countries**  
ENERPAC B.V.  
Galvanistraat 115  
6716 AE Ede  
P.O. Box 8097  
6710 AB Ede  
The Netherlands  
T +31 318 535 911  
F +31 318 535 848  
sales-nl@enerpac.com

**Enerpac Integrated Solutions  
B.V.**  
Opaalstraat 44  
7554 TS Hengelo  
P.O. Box 421  
7550 AK Hengelo  
The Netherlands  
T +31 74 242 20 45  
F +31 74 243 03 38  
integratedsolutions@enerpac.com

**South Africa and other  
English Speaking African  
countries**  
Enerpac Africa Pty Ltd  
No5 Bauhinia Avenue  
Cambridge Office Park  
Block E  
Highveld techno Park  
Centurion 0157  
South Africa  
T: +0027 (0) 12 940 0656  
sales-za@enerpac.com

**United Kingdom and Ireland**  
ENERPAC Ltd.,  
Bentley Road South  
Darlaston, West Midlands  
WS10 8LQ  
England  
T +44 (0)121 50 50 787  
F +44 (0)121 50 50 799  
sales-uk@enerpac.com

**USA, Latin America and  
Caribbean**  
ENERPAC  
P.O. Box 3241  
Milwaukee, WI 53201 USA  
T +1 262 293 1600  
F +1 262 293 7036  
User inquiries:  
+1 800 433 2766  
Distributor inquiries/orders:  
T +1 800 558 0530  
F +1 800 628 0490  
Technical inquiries:  
techservices@enerpac.com  
sales-us@enerpac.com

02/2013

# ENERPAC

## POWERFUL SOLUTIONS. GLOBAL FORCE.

e-mail: info@enerpac.com  
internet: www.enerpacwh.com

Enerpac © 2013  
800US

**AN  
Actuant  
COMPANY**