

# milwaukee *Cylinder*

## Series A

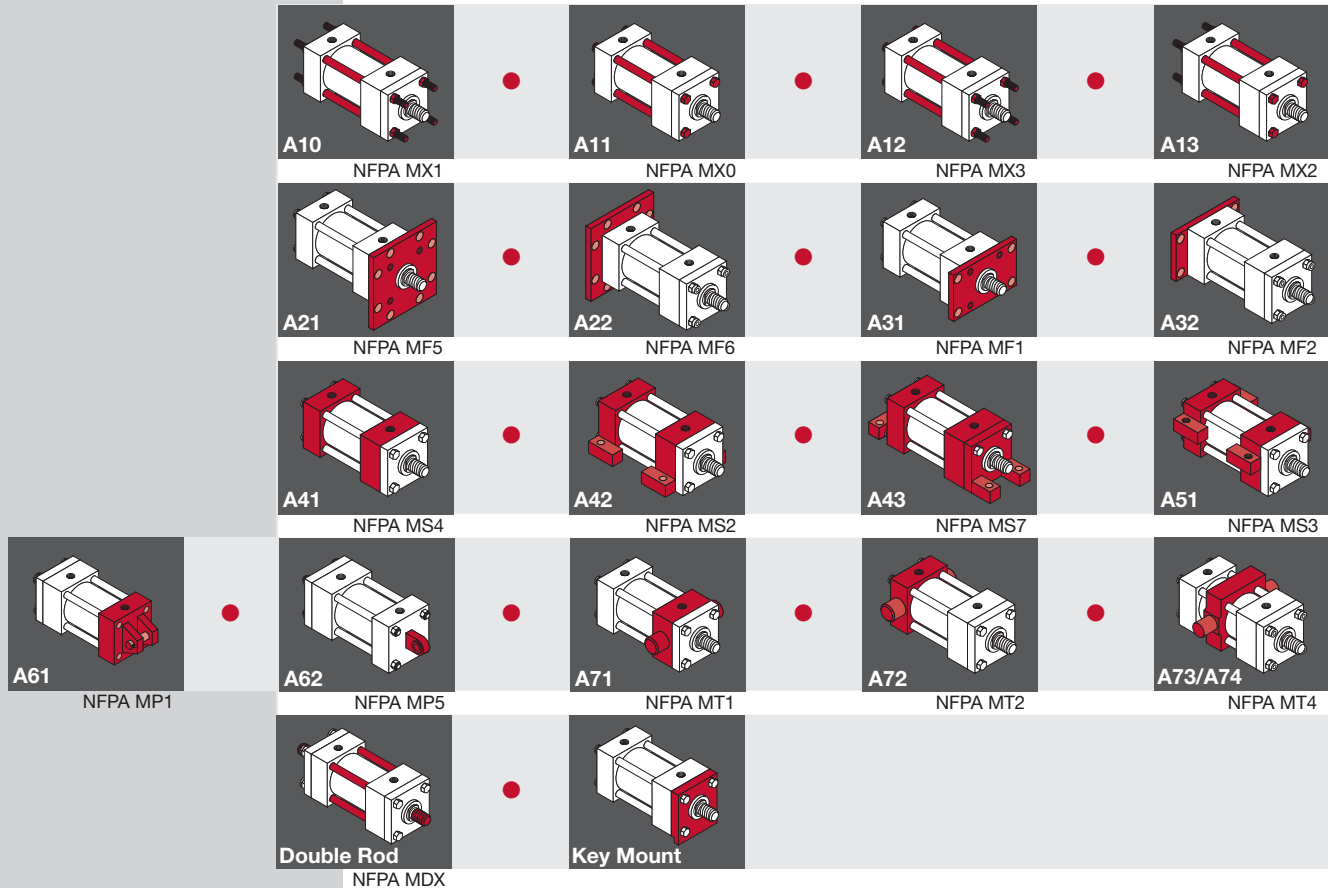

**Milwaukee Cylinder Series A Pneumatic Cylinders** are built to perform on the toughest applications. This heavy-duty air cylinder is designed for 250 psi operation at temperatures between -20° F and +200° F, but can be used at higher temperatures with special seals. *Milwaukee Cylinder's* advanced engineering and quality workmanship ensure you years of maintenance-free service life.

		Page
<b>General</b>	<i>TABLE 3 - Piston Rod End Styles</i>	<i>Inside Cover, page ii</i>
	<i>Standard Specifications and Features</i>	<b>74</b>
	<i>Performance Tested Design Features</i>	<b>75</b>
<b>Mounting Specifications</b>	<i>Tie Rod Mount</i>	<b>76-79</b>
	<i>Flange Mount</i>	<b>80-81</b>
	<i>Solid End Cap Mount</i>	<b>82-83</b>
	<i>Side Mount and Lug Mount</i>	<b>84-87</b>
	<i>Pin Mount and Trunnion Mount</i>	<b>88-91</b>
	<i>Double Rod End Cylinders</i> <i>Key Mount</i>	<b>92</b> <b>93</b>
<b>Additional Information</b>	<i>Design Options</i>	<b>94-95</b>
	<i>Stop Tubes / Cylinder Sizing</i>	<b>96-97</b>
	<i>Ordering Information / Replacement Parts</i>	<b>98-99</b>
	<i>Installation / Trouble Shooting / Maintenance</i>	<b>100-101</b>
<b>Accessories</b>	<i>Clevis / Brackets / Pins / Rod Eyes Dimensional Data</i>	<i>Inside Back Cover</i>

## STANDARD SPECIFICATIONS

- Standard construction – square head – tie rod design
- Nominal pressure – 250 psi air service
- Standard fluid-filtered air
- Standard temperature – -20° F to +200° F
- Standard bore sizes – 1½" to 16"
- Standard piston rod diameters ⅝" thru 5½"
- Standard mounting styles – 17 standard styles plus custom designs to suit your needs
- Strokes – available in any practical stroke length
- Cushions – available at either end or both ends of stroke
- Standard 7 rod end styles, plus specials designed to order
- Rod end style KK<sub>2</sub> - is studded as standard for ⅝" and 1" diameter rods. Studded rod end style is available for all rod sizes.

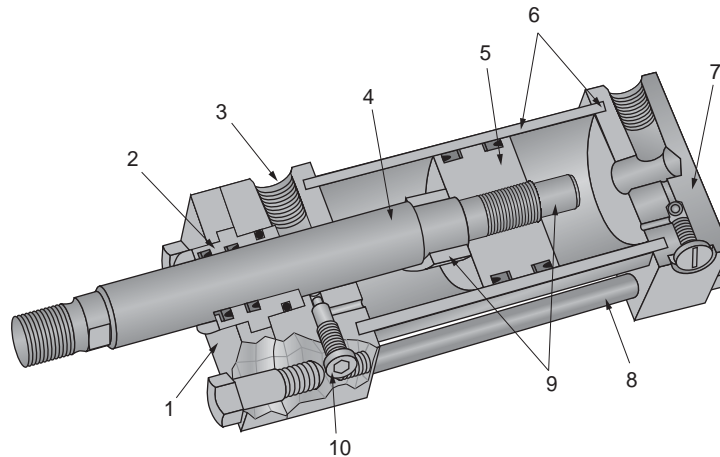

## STANDARD FEATURES

- 1. Removable Retainer Plate**  
 The retainer plate and rod bushing are externally removable. On most models, total disassembly of the cylinder is not necessary. Four capscrews securely hold and lock the retainer plate in place.
- 2. Rod Bushing and Seals**  
 The rod bushing is accurately machined from solid bearing bronze. It is piloted and retained in the end cap to provide positive rod support, and designed for maximum bearing area.  
 Buna-N seals are supplied as standard with *Milwaukee Cylinder Series A* cylinder. They are suitable for use with air or petroleum base fluids up to a temperature of 200°F. For high temperature or synthetic petroleum base fluids, seals of Viton and Teflon are also available.
- 3. Ports**  
 Large NPTF cylinder ports are standard and can be located to customer requirements. SAE ports optional.
- 4. Piston Rod**  
 The piston rod is of high strength steel, hardened and plated to resist scoring and corrosion, assuring maximum life.
- 5. Piston**  
 An iron piston is precision machined from fine grained iron alloy. The piston is pilot fitted and threaded to the rod.
- 6. Cylinder Barrel**  
 The barrel is honed and hard chrome plated. This provides superior sealing power, with the minimum of friction, to assure long seal life. Composite barrel is standard for 10" diameter and larger.
- 7. End Caps**  
 End caps and mountings are of high quality steel, precision machined for accurate mounting.
- 8. Tie-Rods**  
 The tie-rods are constructed from a high quality medium carbon steel. The threads are accurately rolled for rigid engagement of the nuts.
- 9. Cushions**  
 Cushions are machined to close tolerance to provide positive, smooth deceleration at the end of stroke. On all bore sizes, we provide the longest cushion possible, based on the rod size and blind end caps. Longer cushions are available; for further information, consult factory.
- 10. Cushion Needle Adjustment and Ball Check**  
 The cushion needle adjustment valve and cushion-check ball retainer screw are specifically designed to provide full cushion adjustment.



**MilCad Cylinder Configurator**

Visit [milwaukeecylinder.com](http://milwaukeecylinder.com) to configure and download CAD files of your cylinders.

## Combination Rod Seal Design...

The *Milwaukee Cylinder Series A* Cylinder combines a u-cup seal with a double lip wiper as a secondary seal. It is piloted and retained in the end cap to provide positive rod support and maximum bearing area.

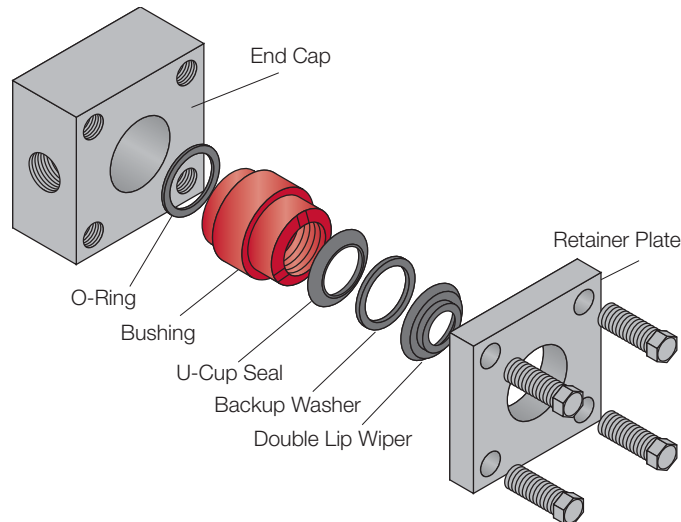

## Simple Maintenance...

Simple maintenance is reality with a *Milwaukee Cylinder*. The rod bushing or rod seals can be inspected or serviced by merely removing the cap screws and retainer plate on most models. Standard available shop tools can be used to remove the rod bushing and seals without disturbing the torque on the tie-rods, assuring performance quality with maintenance ease.

## Piston...

The *Milwaukee Cylinder Series A* cylinder uses two u-cup seals with back-up rings and a fine grained iron alloy piston. This proven piston seal design combines low friction and smooth break away with the near zero leakage of the u-cup seals.

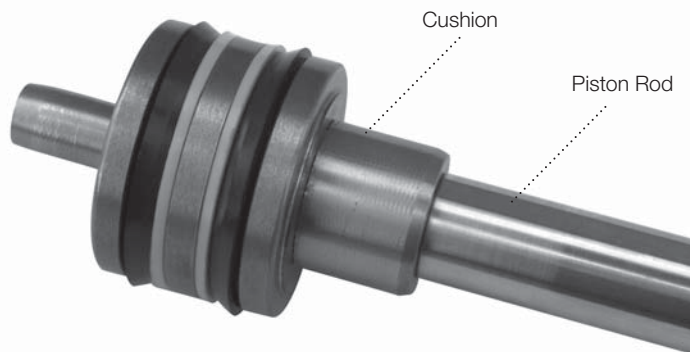

## Cushions...

The cushion is of a high grade alloy, precision machined and specially tapered to provide smooth deceleration of the piston at the end of stroke. The rod end cushion bushing is floated with an O-ring to compensate for minor misalignments during normal operation. This is to assure that our customers receive the total quality of performance that is designed into a *Milwaukee Cylinder* cylinder.

## Piston Rod...

The piston rod is hardened, plated high strength steel, machined and processed to resist scoring and corrosion, assuring maximum life. *Milwaukee Cylinder* offers seven rod end styles as standard. **The style #2 rod end with two wrench flats is furnished as standard**, unless otherwise specified. Special rod ends and extra wrench flats are also available. They must be specified at the time of order, giving the dimensional requirements and the location of additional wrench flats.



**MilCad Cylinder Configurator**

Visit [milwaukeeecylinder.com](http://milwaukeeecylinder.com) to configure and download CAD files of your cylinders.

**For Package and Mounting**

Dimension see  
Tables 1A and 2A.

**TIE ROD MOUNTED CYLINDERS**

Tie-rod mounts are suited for many applications and are similar to flange mounts, but tie-rod mounts are not as rigid as the flange type of mounting. The best use of tie-rods extended on the blind end is in a thrust load application. When using tie-rods extended on the rod end, the best application is a tension load. When long strokes are required, the free end should be supported to prevent misalignment, sagging or possible binding of the cylinder.

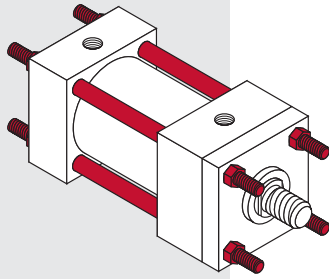

**MODEL A10  
NFA STYLE MX1**

**TIE RODS EXTENDED BOTH ENDS**

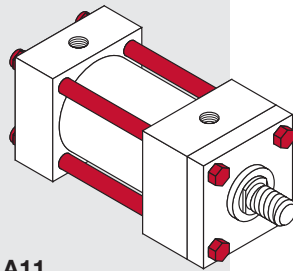
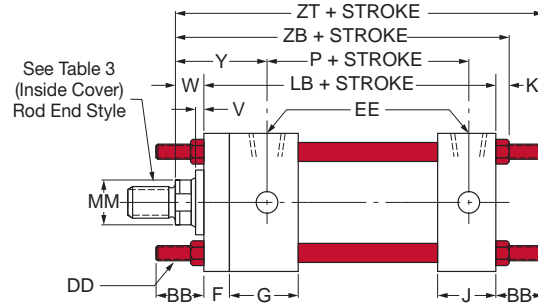
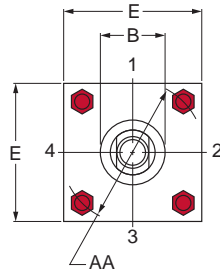

**MODEL A11  
NFA STYLE MX0**

**NO TIE ROD EXTENSION**

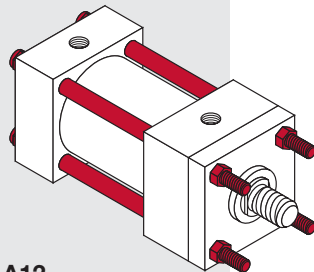
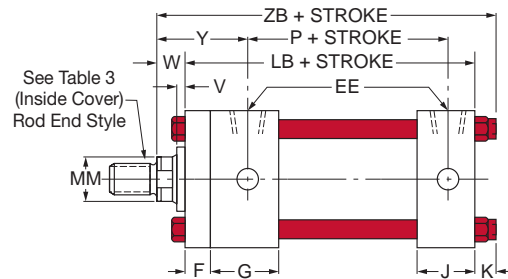
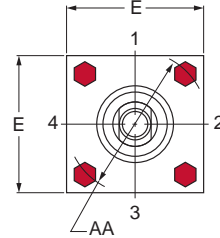

**MODEL A12  
NFA STYLE MX3**

**TIE RODS EXTENDED ROD END**

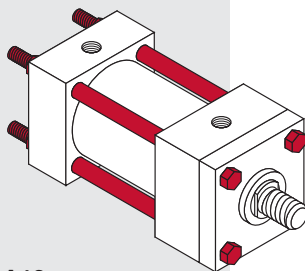
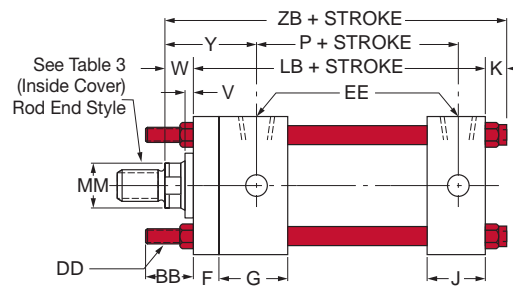
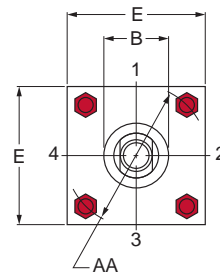

**MODEL A13  
NFA STYLE MX2**

**TIE RODS EXTENDED BLIND END**

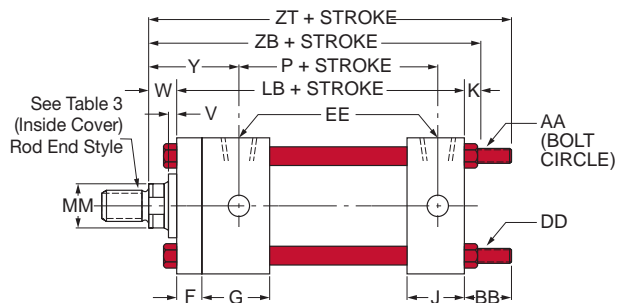
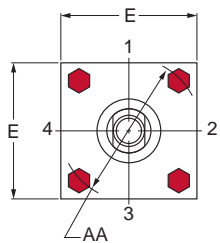

▼ **TABLE 1A**

The dimensions given on this table are affected by the piston rod diameter and the stroke.

Bore Ø	Rod MM	Cylinder Code ↕	B	LB	P	V	W	Y	ZB	ZT
1½	5/8	A0011	1 1/8	4	2 1/4	1/4	5/8	1 15/16	4 7/8	5 5/8
	•1	A0012	1 1/2			1/2	1	2 5/16	5 1/4	6
2	5/8	A0110	1 1/8	4	2 1/4	1/4	5/8	1 15/16	4 15/16	5 3/4
	1	A0111	1 1/2			1/2	1	2 5/16	5 5/16	6 1/8
	•1 3/8	A0112	2			5/8	1 1/4	2 9/16	5 9/16	6 3/8
2½	5/8	A0120	1 1/8	4 1/8	2 3/8	1/4	5/8	1 15/16	5 1/16	5 7/8
	1	A0121	1 1/2			1/2	1	2 5/16	5 7/16	6 1/4
	1 3/8	A0122	2			5/8	1 1/4	2 9/16	5 11/16	6 1/2
	•1 3/4	A0123	2 3/8			3/4	1 1/2	2 13/16	5 15/16	6 3/4
3¼	1	A0130	1 1/2	4 7/8	2 5/8	1/4	3/4	2 7/16	6	7
	1 3/8	A0131	2			3/8	1	2 11/16	6 1/4	7 1/4
	1 3/4	A0132	2 3/8			1/2	1 1/4	2 15/16	6 1/2	7 1/2
	2	A0133	2 5/8			1/2	1 3/8	3 1/16	6 5/8	7 5/8
4	1	A0140	1 1/2	4 7/8	2 5/8	1/4	3/4	2 7/16	6	7
	1 3/8	A0141	2			3/8	1	2 11/16	6 1/4	7 1/4
	1 3/4	A0142	2 3/8			1/2	1 1/4	2 15/16	6 1/2	7 1/2
	2	A0143	2 5/8			1/2	1 3/8	3 1/16	6 5/8	7 5/8
	2 1/2	A0144	3 1/8			5/8	1 5/8	3 5/16	6 7/8	7 7/8
5	1	A1X50	1 1/2	5 1/8	2 7/8	1/4	3/4	2 7/16	6 5/16	7 11/16
	1 3/8	A1X51	2			3/8	1	2 11/16	6 9/16	7 15/16
	1 3/4	A1X52	2 3/8			1/2	1 1/4	2 15/16	6 13/16	8 3/16
	2	A0153	2 5/8			1/2	1 3/8	3 1/16	6 15/16	8 5/16
	2 1/2	A0154	3 1/8			5/8	1 5/8	3 5/16	7 3/16	8 9/16
	3	A0155	3 3/4			5/8	1 5/8	3 5/16	7 3/16	8 9/16
6	3 1/2	A0156	4 1/4	5 3/4	3 1/8	5/8	1 5/8	3 5/16	7 3/16	8 9/16
	1 3/8	A0160	2			1/4	7/8	2 13/16	7 1/16	8 7/16
	1 3/4	A0161	2 3/8			3/8	1 1/8	3 1/16	7 5/16	8 11/16
	2	A0162	2 5/8			3/8	1 1/4	3 3/16	7 7/16	8 13/16
	2 1/2	A0163	3 1/8			1/2	1 1/2	3 7/16	7 11/16	9 1/16
	3	A0164	3 3/4			1/2	1 1/2	3 7/16	7 11/16	9 1/16
	3 1/2	A0165	4 1/4			1/2	1 1/2	3 7/16	7 11/16	9 1/16
4	A0166	4 3/4	1/2	1 1/2	3 7/16	7 11/16	9 1/16			

For bore diameter sizes 8" to 16" see next page.

**HOW TO ORDER**

For ordering information refer to page 98.

**NOTES:**

- ◆ For double rod end cylinders add prefix letter "D" to cylinder code. Example: DA0011. (Refer to page 92.)
- Available with fixed-non-adjustable cushions on rod end and standard adjustable cushions on the blind end only.

**Rod End Styles and Dimensions**  
For rod end styles and dimensions see the Table 3 in the inside cover of the catalog.

Page ii

**MilCad Cylinder Configurator**  
Visit [milwaukeecylinder.com](http://milwaukeecylinder.com) to configure and download CAD files of your cylinders.

▼ **TABLE 2A**

The dimensions are constant regardless of rod diameter or stroke.

Bore Ø	AA	BB	DD	E	EE	F	G	J	K
1½	2.02	1	1/4-28	2	3/8	3/8	1 1/2	1	1/4
2	2.60	1 1/8	5/16-24	2 1/2	3/8	3/8	1 1/2	1	5/16
2½	3.10	1 1/8	5/16-24	3	3/8	3/8	1 1/2	1	5/16
3¼	3.90	1 3/8	3/8-24	3 3/4	1/2	5/8	1 3/4	1 1/4	3/8
4	4.70	1 3/8	3/8-24	4 1/2	1/2	5/8	1 3/4	1 1/4	3/8
5	5.80	1 13/16	1/2-20	5 1/2	1/2	5/8	1 3/4	1 1/4	7/16
6	6.90	1 13/16	1/2-20	6 1/2	3/4	3/4	2	1 1/2	7/16

## For Package and Mounting

Dimension see  
Tables 1A and 2A.

## TIE ROD MOUNTED CYLINDERS

The flange and tie-rod mounts are basically the same, except that the cylinder tie-rods are extended and used to mount the cylinder. To prevent misalignment, sagging or possible binding of the cylinder, when long strokes are required, the free end should be supported. The best use of tie-rods when extending on the blind end is in a thrust load application. When using tie-rods extended on the rod end, the best application is a tension load. Tie-rod mounts are suited for many applications, but it should be noted that they are not as rigid as the flange type of mounting.

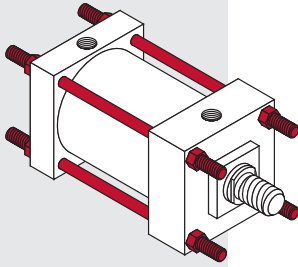

**MODEL A10**  
**NFPA STYLE MX1**

### TIE RODS EXTENDED BOTH ENDS

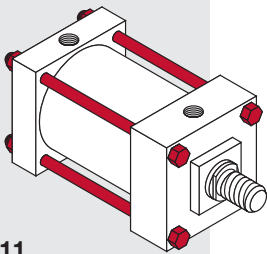
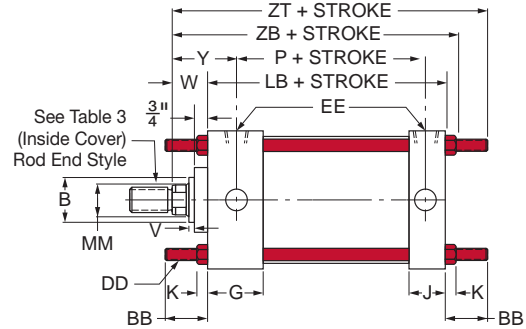
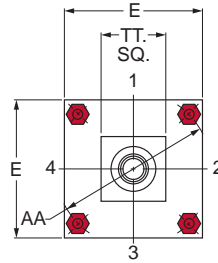

**MODEL A11**  
**NFPA STYLE MX**

### NO TIE ROD EXTENSION

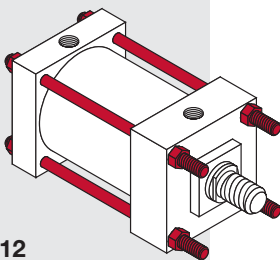
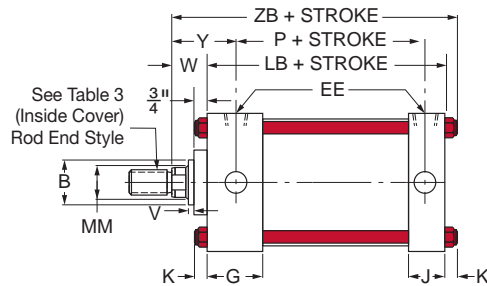
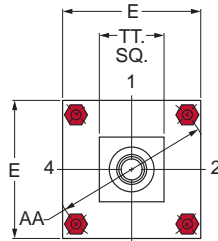

**MODEL A12**  
**NFPA STYLE MX3**

### TIE RODS EXTENDED ROD END

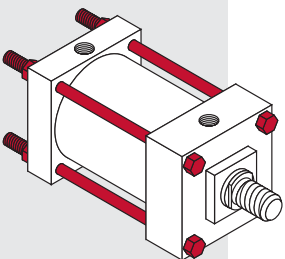
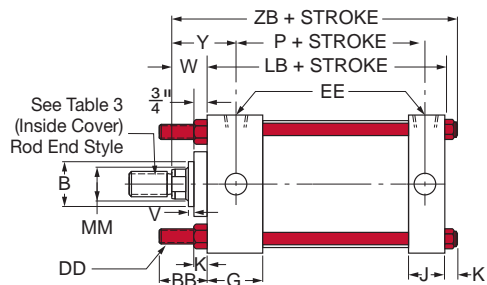
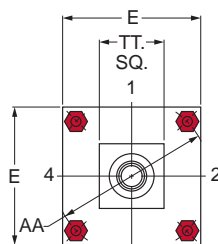

**MODEL A13**  
**NFPA STYLE MX2**

### TIE RODS EXTENDED BLIND END

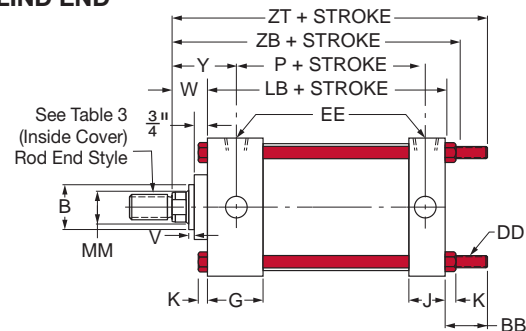
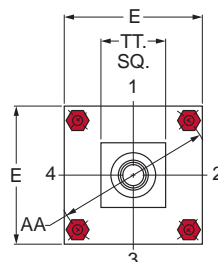



▼ **TABLE 1A**

The dimensions given on this table are affected by the piston rod diameter and the stroke.

Bore Ø	Rod MM	Cylinder Code ♦	B	LB	P	TT	V	W	Y	ZB	ZT
8	1 3/8	A0180	2	5 1/8	3 1/4	4	1/4	1 5/8	2 13/16	7 5/16	9 1/16
	1 3/4	A0181	2 3/8			4	3/8	1 7/8	3 1/16	7 9/16	9 5/16
	2	A0182	2 5/8			4	3/8	2	3 3/16	7 1 1/16	9 7/16
	2 1/2	A0183	3 1/8			4					
	3	A0184	3 3/4			5 1/2					
	3 1/2	A0185	4 1/4			5 1/2					
	4	A0186	4 3/4			5 1/2	1/2	2 1/4	3 7/16	7 15/16	9 11/16
	4 1/2	A0187	5 1/4			7					
5	A0188	5 3/4	7								
5 1/2	A0189	6 1/4	7								
10	1 3/4	A1100	2 3/8	6 3/8	4 1/8	4	3/8	1 7/8	3 1/8	8 15/16	10 15/16
	2	A1101	2 5/8			4	3/8	2	3 1/4	9 1/16	11 1/16
	2 1/2	A1102	3 1/8			4					
	3	A1103	3 3/4			5 1/2					
	3 1/2	A1104	4 1/4			5 1/2					
	4	A1105	4 3/4			5 1/2	1/2	2 1/4	3 1/2	9 5/16	11 5/16
	4 1/2	A1106	5 1/4			7					
	5	A1107	5 3/4			7					
5 1/2	A1108	6 1/4	7								
12	2	A1120	2 5/8	6 7/8	4 5/8	4	3/8	2	3 1/4	9 9/16	11 9/16
	2 1/2	A1121	3 1/8			4					
	3	A1122	3 3/4			5 1/2					
	3 1/2	A1123	4 1/4			5 1/2					
	4	A1124	4 3/4			5 1/2	1/2	2 1/4	3 1/2	9 13/16	11 13/16
	4 1/2	A1125	5 1/4			7					
	5	A1126	5 3/4			7					
5 1/2	A1127	6 1/4	7								
14	2 1/2	A1140	3 1/8	8 1/8	5 1/2	4					
	3	A1141	3 3/4			5 1/2					
	3 1/2	A1142	4 1/4			5 1/2					
	4	A1143	4 3/4			5 1/2	1/2	2 1/4	3 13/16	11 3/16	13 3/16
	4 1/2	A1144	5 1/4			7					
	5	A1145	5 3/4			7					
5 1/2	A1146	6 1/4	7								
16	2 1/2	A1160	3 1/8	8 1/8	5 5/8	4					
	3	A1161	3 3/4			5 1/2					
	3 1/2	A1162	4 1/4			5 1/2					
	4	A1163	4 3/4			5 1/2	1/2	2 1/4	3 3/4	11 3/16	13 3/16
	4 1/2	A1164	5 1/4			7					
	5	A1165	5 3/4			7					
5 1/2	A1166	6 1/4	7								

▼ **TABLE 2A**

The dimensions are constant regardless of rod diameter or stroke.

Bore Ø	AA	BB	DD	E	EE	G	J	K
8	9.10	2 5/16	5/8-18	8 1/2	3/4	2	1 1/2	9/16
10	11.20	2 1 1/16	3/4-16	10 5/8	1	2 1/4	2	1 1/16
12	13.30	2 1 1/16	3/4-16	12 3/4	1	2 1/4	2	1 1/16
14	15.40	3 3/16	7/8-14	14 3/4	1 1/4	2 3/4	2 1/4	1 3/16
16	17.90	3 3/16	7/8-14	17	1 1/4	2 3/4	2 1/4	1 3/16

**HOW TO ORDER**

For ordering information refer to page 98.

**NOTES:**

- ♦ For double rod end cylinders add prefix letter "D" to cylinder code. Example: DA0180. (Refer to page 92.)



**Rod End Styles and Dimensions**  
For rod end styles and dimensions see the Table 3 in the inside cover of the catalog.  
Page ii



**MilCad Cylinder Configurator**  
Visit [milwaukeecylinder.com](http://milwaukeecylinder.com) to configure and download CAD files of your cylinders.



## For Package and Mounting

Dimension see  
Tables 1A and 2A.

## FLANGE MOUNTED CYLINDERS

The flange mount is one of the strongest, most rigid methods of mounting. With this type of mount there is little allowance for misalignment, though when long strokes are required, the free end opposite the mounting should be supported to prevent sagging and possible binding of the cylinder. The best use of a blind end flange is in a thrust load application (rod in compression). Rod end flange mounts are best used in tension applications. When a less rigid mount can be used and the cylinder can be attached to a panel or bulkhead, an extended tie-rod mounting could be considered.

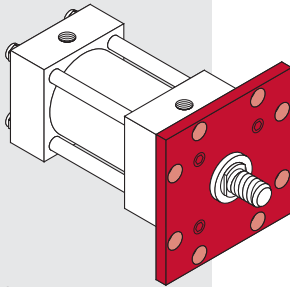

**MODEL A21**  
NFPA STYLE MF5

### ROD SQUARE FLANGE MOUNTING

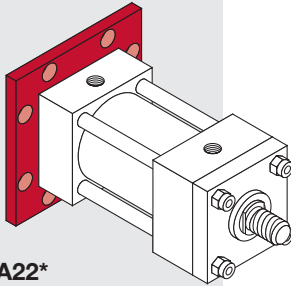
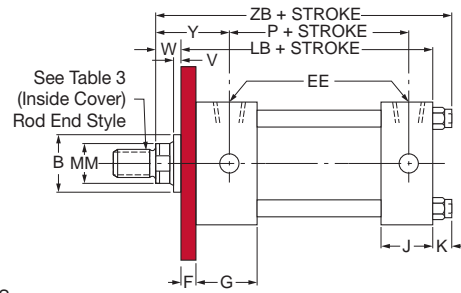
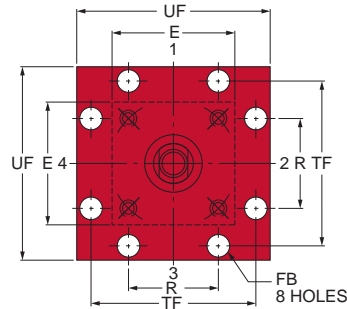

**MODEL A22\***  
NFPA STYLE MF6

### BLIND SQUARE FLANGE MOUNTING

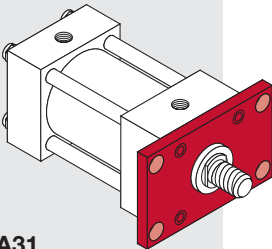
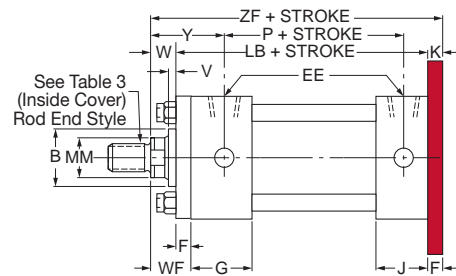
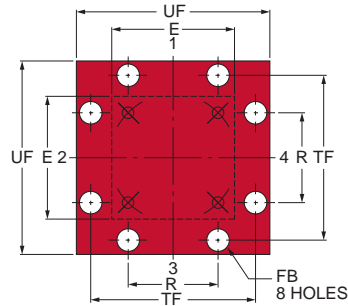

**MODEL A31**  
NFPA STYLE MF1

### ROD RECTANGULAR FLANGE MOUNTING

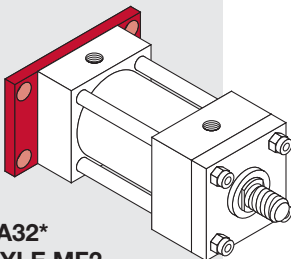
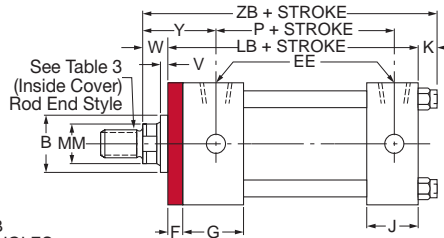
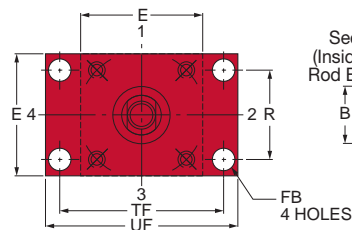

**MODEL A32\***  
NFPA STYLE MF2

### BLIND RECTANGULAR FLANGE MOUNTING

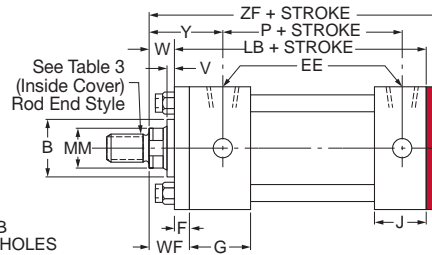
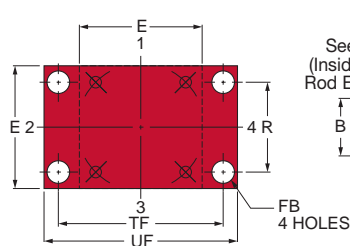

**▼ TABLE 1A**

The dimensions given on this table are affected by the piston rod diameter and the stroke.

Bore Ø	Rod MM	Cylinder Code ↕	B	LB	P	V	W	Y	ZB	ZF
1½	⅝	A0011	1⅛	4	2¼	¼	⅝	1 <sup>15</sup> / <sub>16</sub>	4 <sup>7</sup> / <sub>8</sub>	5
	•1*	A0012	1½			½	1	2 <sup>5</sup> / <sub>16</sub>	5¼	5 <sup>3</sup> / <sub>8</sub>
2	⅝	A0110	1⅛	4	2¼	¼	⅝	1 <sup>15</sup> / <sub>16</sub>	4 <sup>15</sup> / <sub>16</sub>	5
	1	A0111	1½			½	1	2 <sup>5</sup> / <sub>16</sub>	5 <sup>5</sup> / <sub>16</sub>	5 <sup>3</sup> / <sub>8</sub>
	•1⅜*	A0112	2			⅝	1¼	2 <sup>5</sup> / <sub>16</sub>	5 <sup>5</sup> / <sub>16</sub>	5 <sup>5</sup> / <sub>8</sub>
2½	⅝	A0120	1⅛	4⅞	2⅜	¼	⅝	1 <sup>15</sup> / <sub>16</sub>	5 <sup>1</sup> / <sub>16</sub>	5⅞
	1	A0121	1½			½	1	2 <sup>5</sup> / <sub>16</sub>	5 <sup>7</sup> / <sub>16</sub>	5½
	1⅜	A0122	2			⅝	1¼	2 <sup>5</sup> / <sub>16</sub>	5 <sup>1</sup> / <sub>16</sub>	5¾
	•1¾*	A0123	2⅜			¾	1½	2 <sup>13</sup> / <sub>16</sub>	5 <sup>15</sup> / <sub>16</sub>	6
3¼	1	A0130	1½	4 <sup>7</sup> / <sub>8</sub>	2 <sup>5</sup> / <sub>8</sub>	¼	¾	2 <sup>7</sup> / <sub>16</sub>	6	6¼
	1⅜	A0131	2			⅜	1	2 <sup>11</sup> / <sub>16</sub>	6¼	6½
	1¾	A0132	2⅜			½	1¼	2 <sup>15</sup> / <sub>16</sub>	6½	6¾
	2*	A0133	2 <sup>5</sup> / <sub>8</sub>			½	1⅜	3 <sup>1</sup> / <sub>16</sub>	6 <sup>5</sup> / <sub>8</sub>	6 <sup>7</sup> / <sub>8</sub>
4	1	A0140	1½	4 <sup>7</sup> / <sub>8</sub>	2 <sup>5</sup> / <sub>8</sub>	¼	¾	2 <sup>7</sup> / <sub>16</sub>	6	6¼
	1⅜	A0141	2			⅜	1	2 <sup>11</sup> / <sub>16</sub>	6¼	6½
	1¾	A0142	2⅜			½	1¼	2 <sup>15</sup> / <sub>16</sub>	6½	6¾
	2	A0143	2 <sup>5</sup> / <sub>8</sub>			½	1⅜	3 <sup>1</sup> / <sub>16</sub>	6 <sup>5</sup> / <sub>8</sub>	6 <sup>7</sup> / <sub>8</sub>
	2½*	A0144	3⅛			⅝	1⅝	3 <sup>5</sup> / <sub>16</sub>	6 <sup>7</sup> / <sub>8</sub>	7⅛
5	1	A1x50	1½	5⅞	2 <sup>7</sup> / <sub>8</sub>	¼	¾	2 <sup>7</sup> / <sub>16</sub>	6 <sup>5</sup> / <sub>16</sub>	6½
	1⅜	A1x51	2			⅜	1	2 <sup>11</sup> / <sub>16</sub>	6 <sup>9</sup> / <sub>16</sub>	6¾
	1¾	A1x52	2⅜			½	1¼	2 <sup>15</sup> / <sub>16</sub>	6 <sup>13</sup> / <sub>16</sub>	7
	2	A0153	2 <sup>5</sup> / <sub>8</sub>			½	1⅜	3 <sup>1</sup> / <sub>16</sub>	6 <sup>15</sup> / <sub>16</sub>	7⅛
	2½	A0154	3⅛			⅝	1⅝	3 <sup>5</sup> / <sub>16</sub>	7 <sup>3</sup> / <sub>16</sub>	7 <sup>3</sup> / <sub>8</sub>
	3	A0155	3¾			⅝	1⅝	3 <sup>5</sup> / <sub>16</sub>	7 <sup>3</sup> / <sub>16</sub>	7 <sup>3</sup> / <sub>8</sub>
6	3½*	A0156	4¼	5¾	3⅞	⅝	1⅝	3 <sup>5</sup> / <sub>16</sub>	7 <sup>3</sup> / <sub>16</sub>	7 <sup>3</sup> / <sub>8</sub>
	1⅜	A0160	2			¼	7 <sup>8</sup> / <sub>8</sub>	2 <sup>13</sup> / <sub>16</sub>	7 <sup>1</sup> / <sub>16</sub>	7 <sup>3</sup> / <sub>8</sub>
	1¾	A0161	2⅜			⅜	1⅞	3 <sup>1</sup> / <sub>16</sub>	7 <sup>5</sup> / <sub>16</sub>	7 <sup>5</sup> / <sub>8</sub>
	2	A0162	2 <sup>5</sup> / <sub>8</sub>			⅜	1¼	3 <sup>3</sup> / <sub>16</sub>	7 <sup>7</sup> / <sub>16</sub>	7 <sup>3</sup> / <sub>4</sub>
	2½	A0163	3⅛			½	1½	3 <sup>7</sup> / <sub>16</sub>	7 <sup>11</sup> / <sub>16</sub>	8
	3	A0164	3¾			½	1½	3 <sup>7</sup> / <sub>16</sub>	7 <sup>11</sup> / <sub>16</sub>	8
	3½	A0165	4¼			½	1½	3 <sup>7</sup> / <sub>16</sub>	7 <sup>11</sup> / <sub>16</sub>	8
4	A0166	4¾	½	1½	3 <sup>7</sup> / <sub>16</sub>	7 <sup>11</sup> / <sub>16</sub>	8			

For bore diameter sizes 8" to 16" see next page.

**▼ TABLE 2A**

The dimensions are constant regardless of rod diameter or stroke.

Bore Ø	E	EE	F	FB	G	J	K	R	TF	UF
1½	2	⅜	⅜	5 <sup>1</sup> / <sub>16</sub>	1½	1	¼	1.43	2¾	3⅜
2	2½	⅜	⅜	⅜	1½	1	5 <sup>1</sup> / <sub>16</sub>	1.84	3⅜	4⅞
2½	3	⅜	⅜	⅜	1½	1	5 <sup>1</sup> / <sub>16</sub>	2.19	3⅜	4 <sup>5</sup> / <sub>8</sub>
3¼	3¾	½	⅝	7 <sup>1</sup> / <sub>16</sub>	1¾	1¼	⅜	2.76	4 <sup>11</sup> / <sub>16</sub>	5½
4	4½	½	⅝	7 <sup>1</sup> / <sub>16</sub>	1¾	1¼	⅜	3.32	5 <sup>7</sup> / <sub>16</sub>	6¼
5	5½	½	⅝	9 <sup>1</sup> / <sub>16</sub>	1¾	1¼	7 <sup>1</sup> / <sub>16</sub>	4.10	6 <sup>5</sup> / <sub>8</sub>	7 <sup>5</sup> / <sub>8</sub>
6	6½	¾	¾	9 <sup>1</sup> / <sub>16</sub>	2	1½	7 <sup>1</sup> / <sub>16</sub>	4.88	7 <sup>5</sup> / <sub>8</sub>	8 <sup>5</sup> / <sub>8</sub>

**HOW TO ORDER**

For ordering information refer to Page 98.

**NOTES:**

- ◆ For double rod end cylinders add prefix letter "D" to cylinder code. Example: DA0011. (Refer to page 92.)
- Available with fixed-non-adjustable cushions on rod end and standard adjustable cushions on the blind end only.
- \* Removable retainer not available for these bore and rod combinations in the A22 and A32 mounting styles.

**i Rod End Styles and Dimensions**  
 For rod end styles and dimensions see the Table 3 in the inside cover of the catalog.  
 Page ii

**MilCad Cylinder Configurator**  
 Visit [milwaukeekeeylinder.com](http://milwaukeekeeylinder.com) to configure and download CAD files of your cylinders.

Series H

Series MH

Series LH

Series A

For Package and Mounting

Dimension see  
Tables 1A and 2A.

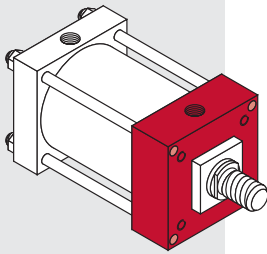

**MODEL A21  
NFPA STYLE ME3**

## SOLID ROD END CAP MOUNTED CYLINDERS

Milwaukee Cylinder's solid end cap mount is one of the strongest, most rigid methods of mounting. This type of rod end cap mounting is best in a tension application. A solid blind end cap mounting is best in a thrust application.

### SOLID ROD END CAP SQUARE MOUNTING

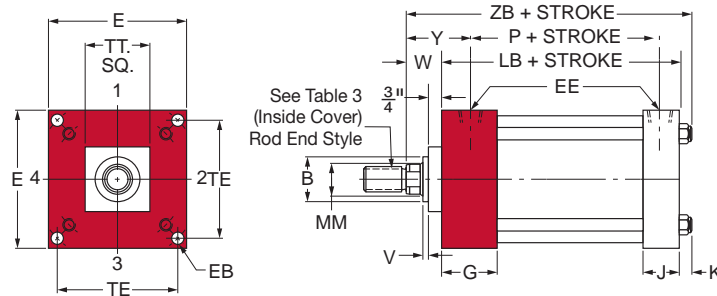

### SOLID BLIND END CAP SQUARE MOUNTING

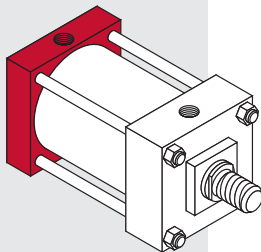

**MODEL A22  
NFPA STYLE ME4**

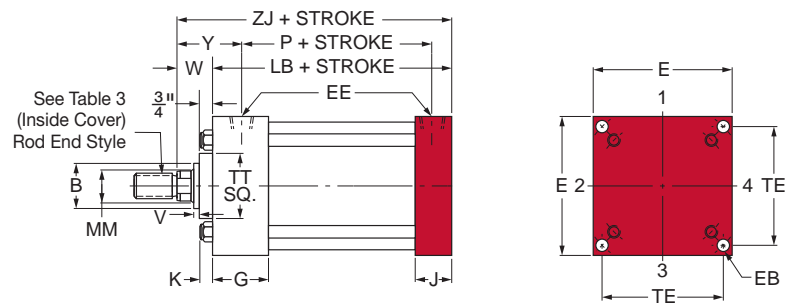

**TABLE 1A**

The dimensions given on this table are affected by the piston rod diameter and the stroke.

Bore Ø	Rod MM	Cylinder Code	B	LB	P	TT	V	W	Y	ZB	ZJ
8	1 3/8	A0180	2	5 1/8	3 1/4	4	1/4	1 5/8	2 13/16	7 5/16	6 3/4
	1 3/4	A0181	2 3/8			4	3/8	1 7/8	3 1/16	7 9/16	7
	2	A0182	2 5/8			4	3/8	2	3 3/16	7 11/16	7 1/8
	2 1/2	A0183	3 1/8			4					
	3	A0184	3 3/4			5 1/2					
	3 1/2	A0185	4 1/4			5 1/2					
	4	A0186	4 3/4			5 1/2	1/2	2 1/4	3 7/16	7 15/16	7 3/8
	4 1/2	A0187	5 1/4			7					
5	A0188	5 3/4	7								
5 1/2	A0189	6 1/4	7								
10	1 3/4	A1100	2 3/8	6 3/8	4 1/8	4	3/8	1 7/8	3 1/8	8 15/16	8 1/4
	2	A1101	2 5/8			4	3/8	2	3 1/4	9 1/16	8 3/8
	2 1/2	A1102	3 1/8			4					
	3	A1103	3 3/4			5 1/2					
	3 1/2	A1104	4 1/4			5 1/2					
	4	A1105	4 3/4			5 1/2	1/2	2 1/4	3 1/2	9 5/16	8 5/8
	4 1/2	A1106	5 1/4			7					
	5	A1107	5 3/4			7					
5 1/2	A1108	6 1/4	7								
12	2	A1120	2 5/8	6 7/8	4 5/8	4	3/8	2	3 1/4	9 9/16	8 7/8
	2 1/2	A1121	3 1/8			4					
	3	A1122	3 3/4			5 1/2					
	3 1/2	A1123	4 1/4			5 1/2					
	4	A1124	4 3/4			5 1/2	1/2	2 1/4	3 1/2	9 13/16	9 1/8
	4 1/2	A1125	5 1/4			7					
	5	A1126	5 3/4			7					
5 1/2	A1127	6 1/4	7								
14	2 1/2	A1140	3 1/8	8 1/8	5 1/2	4					
	3	A1141	3 3/4			5 1/2					
	3 1/2	A1142	4 1/4			5 1/2					
	4	A1143	4 3/4			5 1/2	1/2	2 1/4	3 13/16	11 3/16	10 3/8
	4 1/2	A1144	5 1/4			7					
	5	A1145	5 3/4			7					
5 1/2	A1146	6 1/4	7								
16	2 1/2	A1160	3 1/8	8 1/8	5 5/8	4					
	3	A1161	3 3/4			5 1/2					
	3 1/2	A1162	4 1/4			5 1/2					
	4	A1163	4 3/4			5 1/2	1/2	2 1/4	3 3/4	11 3/16	10 3/8
	4 1/2	A1164	5 1/4			7					
	5	A1165	5 3/4			7					
5 1/2	A1166	6 1/4	7								

**TABLE 2A**

The dimensions are constant regardless of rod diameter or stroke.

Bore Ø	E	EB	EE	R	G	J	K	R	TE
8	8 1/2	1 1/16	3/4	-	2	1 1/2	9/16	6.44	7.57
10	10 5/8	1 3/16	1	-	2 1/4	2	1 1/16	7.92	9.40
12	12 3/4	1 3/16	1	-	2 1/4	2	1 1/16	9.40	11.10
14	14 3/4	1 5/16	1 1/4	-	2 3/4	2 1/4	1 3/16	10.90	12.87
16	17	1 1/16	1 1/4	-	2 3/4	2 1/4	1 3/16	12.65	14.85

**HOW TO ORDER**

For ordering information refer to page 98.

**NOTES:**

- ◆ For double rod end cylinders add prefix letter "D" to cylinder code. Example: DA0180. (Refer to page 92.)

**Information**  
**Rod End Styles and Dimensions**  
 For rod end styles and dimensions see the Table 3 in the inside cover of the catalog.  
 Page ii

**MilCad Cylinder Configurator**  
 Visit [milwaukee-cylinder.com](http://milwaukee-cylinder.com) to configure and download CAD files of your cylinders.

Series H

Series MH

Series LH

Series A

## For Package and Mounting

Dimension see  
Tables 1A and 2A.

## SIDE OR LUG MOUNTED CYLINDERS

The side or lug mounted cylinder provides a fairly rigid mount. These types of cylinders can tolerate a slight amount of misalignment when the cylinder is at full stroke, but as the piston moves toward the blind end, the tolerance for misalignment decreases. It is important to note that if the cylinder is used properly (without misalignment), the mounting bolts are either in simple shear or tension without any compound stresses.

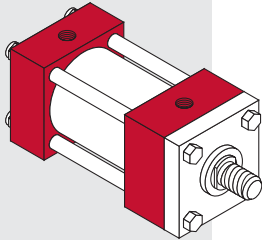

**MODEL A41**  
**NFPA STYLE MS4**

### TAPPED HOLES IN CAPS FLUSH MOUNTING

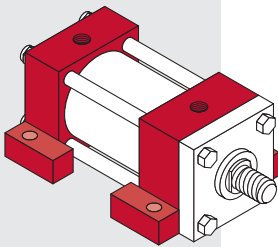
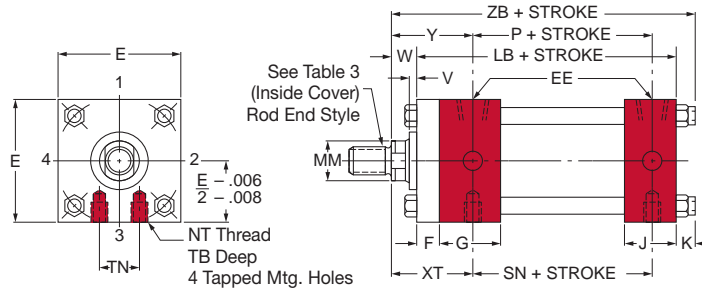

**MODEL A42**  
**NFPA STYLE MS2**

### SIDE LUG MOUNTING

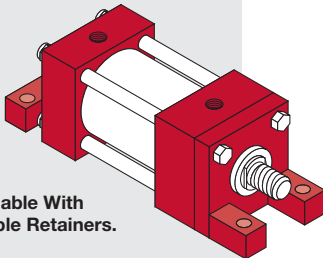
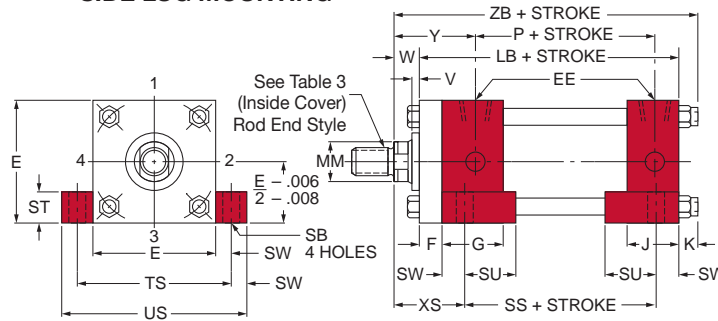

Not Available With  
Removable Retainers.

**MODEL A43**  
**NFPA STYLE MS7**

### FOOT MOUNTING

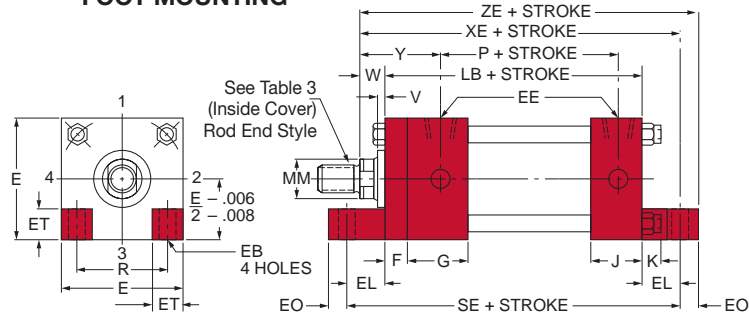

### CENTERLINE LUG MOUNTING

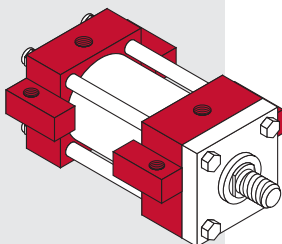
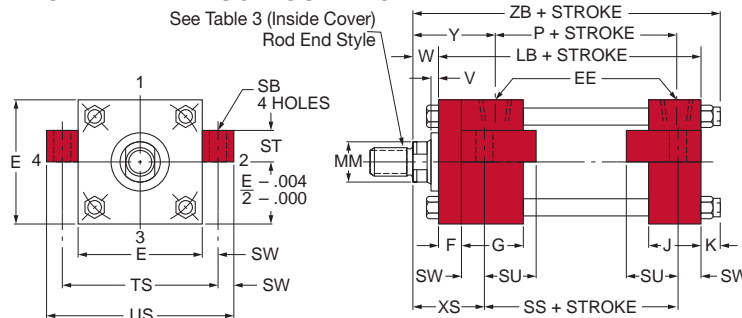

**MODEL A51**  
**NFPA STYLE MS3**

**TABLE 1A**

The dimensions given on this table are affected by the piston rod diameter and the stroke.

Bore Ø	Rod MM	Cylinder Code ♦	LB	P	SE ▲	SN	SS ■	V	W	XE	XS	XT	Y	ZB	ZE
1½	5/8	A0011	4	2¼	5½	2¼	27/8	¼	5/8	53/8	13/8	115/16	115/16	47/8	53/8
	•1*	A0012						½	1	53/4	13/4	25/16	25/16	5¼	6
2	5/8	A0110	4	2¼	57/8	2¼	27/8	¼	5/8	59/16	13/8	115/16	115/16	415/16	57/8
	†1*	A0111						½	1	515/16	13/4	25/16	25/16	55/16	6¼
	•13/8*	A0112						5/8	1¼	63/16	2	29/16	29/16	59/16	6½
2½	5/8	A0120	4½	23/8	6¼	23/8	3	¼	5/8	513/16	13/8	115/16	115/16	51/16	61/8
	1	A0121						½	1	63/16	13/4	25/16	25/16	57/16	6½
	†13/8*	A0122						5/8	1¼	67/16	2	29/16	29/16	511/16	63/4
	•13/4*	A0123						3/4	1½	611/16	2¼	213/16	213/16	615/16	7
3¼	1	A0130	47/8	25/8	65/8	25/8	3¼	¼	3/4	6½	17/8	27/16	27/16	6	67/8
	13/8	A0131						3/8	1	63/4	21/8	211/16	211/16	6¼	71/8
	13/4*	A0132						½	1¼	7	23/8	215/16	215/16	6½	73/8
	2*	A0133						½	13/8	71/8	2½	31/16	31/16	65/8	7½
4	1	A0140	47/8	25/8	67/8	25/8	3¼	¼	3/4	65/8	17/8	27/16	27/16	6	7
	13/8	A0141						3/8	1	67/8	21/8	211/16	211/16	6¼	7¼
	13/4	A0142						½	1¼	71/8	23/8	215/16	215/16	6½	7½
	2	A0143						½	13/8	7¼	2½	31/16	31/16	65/8	75/8
	2½*	A0144						5/8	15/8	7½	2¾	35/16	35/16	67/8	77/8
5	1	A1x50	5½	27/8	7¼	27/8	3½	¼	3/4	615/16	21/16	27/16	27/16	65/16	77/16
	13/8	A1x51						3/8	1	73/16	25/16	211/16	211/16	69/16	711/16
	13/4	A1x52						½	1¼	77/16	29/16	215/16	215/16	613/16	715/16
	2	A0153						½	13/8	79/16	211/16	31/16	31/16	615/16	81/16
	2½	A0154						5/8	15/8	713/16	215/16	35/16	35/16	73/16	85/16
	3	A0155						5/8	15/8	713/16	215/16	35/16	35/16	73/16	85/16
6	13/8	A0160	5¾	31/8	7¾	31/8	35/8	¼	7/8	75/8	25/16	213/16	213/16	71/16	81/8
	13/4	A0161						3/8	11/8	77/8	29/16	31/16	31/16	75/16	83/8
	2	A0162						3/8	1¼	8	211/16	33/16	33/16	77/16	8½
	2½	A0163						½	1½	8¼	215/16	37/16	37/16	711/16	8¾
	3	A0164						½	1½	8¼	215/16	37/16	37/16	711/16	8¾
	3½	A0165						½	1½	8¼	215/16	37/16	37/16	711/16	8¾
	4*	A0166						½	1½	8¼	215/16	37/16	37/16	711/16	8¾

For bore diameter sizes 8" to 16" see next page.

**HOW TO ORDER**

For ordering information refer to Page 98.

**NOTES:**

♦ For double rod end cylinders add prefix letter "D" to cylinder code. Example: DA0011. (Refer to page 92.)

\* Tapped holes on A41 rod end cap have a shallower TB depth in these sizes.

† The standard rod eye or rod clevis will interfere with foot lugs on Model A43. When these rod end accessories are required, use additional rod extension.

▲ For double rod end cylinders from 1½" thru 6" bore, add ½ + F to this dimension.

■ For double rod end cylinders from 1½" thru 6" bore, add ½ to this dimension.

• Available with fixed non-adjustable cushions on rod end and standard adjustable cushions on the blind end only.



**Rod End Styles and Dimensions**  
For rod end styles and dimensions see the Table 3 in the inside cover of the catalog.

Page ii

**TABLE 2A**

The dimensions are constant regardless of rod diameter or stroke.

Bore Ø	E	EB	EE	EL	EO	ET	F	G	J	K	NT	R	SB	ST	SU	SW	TB	TN	TS	US
1½	2	5/16	3/8	3/4	¼	½	3/8	1½	1	¼	¼-20	1.43	7/16	½	15/16	3/8	3/8	5/8	2¾	3½
2	2½	3/8	3/8	15/16	5/16	19/32	3/8	1½	1	5/16	5/16-18	1.84	7/16	½	15/16	3/8	9/16	7/8	3¼	4
2½	3	3/8	3/8	11/16	5/16	¾	3/8	1½	1	5/16	3/8-16	2.19	7/16	½	15/16	3/8	5/8	1¼	3¾	4½
3¼	3¾	7/16	½	7/8	3/8	29/32	5/8	1¾	1¼	3/8	½-13	2.76	9/16	¾	1¼	½	¾	1½	4¾	5¾
4	4½	7/16	½	1	3/8	11/8	5/8	1¾	1¼	3/8	½-13	3.32	9/16	¾	1¼	½	1	21/16	5½	6½
5	5½	9/16	½	11/16	½	111/32	5/8	1¾	1¼	7/16	5/8-11	4.10	13/16	1	19/16	11/16	1	211/16	67/8	8¼
6	6½	9/16	¾	1	½	19/16	¾	2	1½	7/16	¾-10	4.88	13/16	1	19/16	11/16	11/8	3¼	77/8	9¼

Series H

Series MH

Series LH

Series A

**For Package and Mounting**

Dimension see  
Tables 1A and 2A.

**SIDE OR LUG MOUNTED CYLINDERS**

The side or lug mounted cylinder provides a fairly rigid mount. These types of cylinders can tolerate a slight amount of misalignment when the cylinder is at full stroke, but as the piston moves toward the blind end, the tolerance for misalignment decreases. It is important to note that if the cylinder is used properly (without misalignment), the mounting bolts are either in simple shear or tension without any compound stresses.

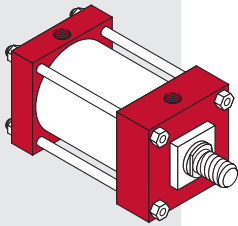

**MODEL A41  
NFPA STYLE MS4**

**TAPPED HOLES IN CAPS FLUSH MOUNTING**

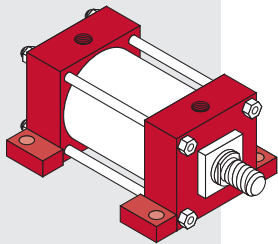
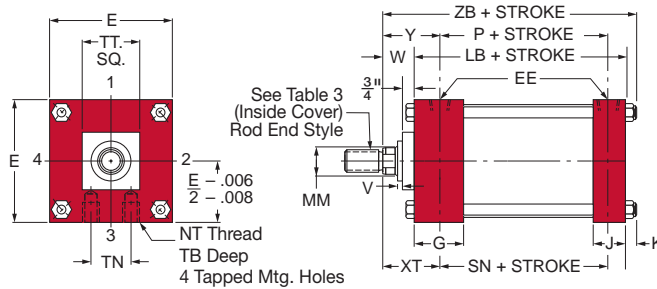

**MODEL A42  
NFPA STYLE MS2**

**SIDE LUG MOUNTING**

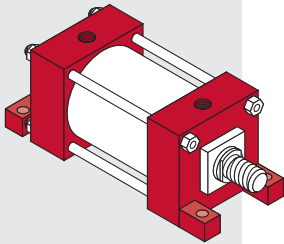
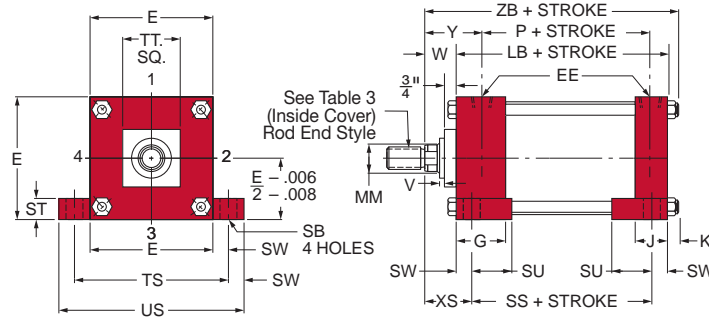

**MODEL A43  
NFPA STYLE MS7**

**FOOT MOUNTING**

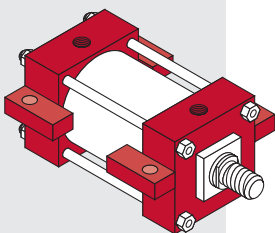
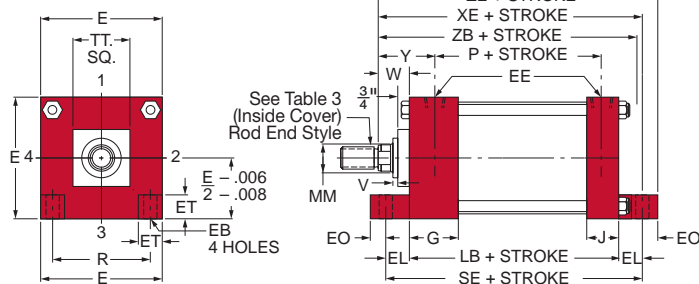

**MODEL A51  
NFPA STYLE MS3**

**CENTERLINE LUG MOUNTING**

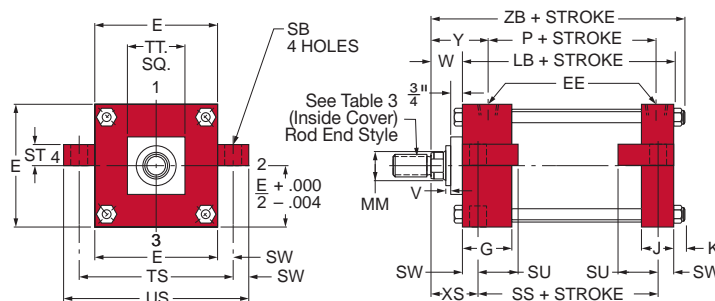



**TABLE 1A**

The dimensions given on this table are affected by the piston rod diameter and the stroke.

Bore Ø	Rod MM	Cylinder Code	LB	P	SE	SN	SS	TT	V	W	XE	XS	XT	Y	ZB	ZE
8	1 3/8	A0180						4	1/4	1 5/8	7 7/8	2 5/16	2 13/16	2 13/16	7 5/16	8 1/2
	1 3/4	A0181						4	3/8	1 7/8	8 1/8	2 9/16	3 1/16	3 1/16	7 9/16	8 3/4
	2	A0182						4	3/8	2	8 1/4	2 11/16	3 3/16	3 3/16	7 11/16	8 7/8
	2 1/2	A0183						4								
	3*	A0184	5 1/8	3 1/4	7 3/8	3 1/4	3 3/4	5 1/2								
	3 1/2*	A0185						5 1/2								
	4*	A0186						5 1/2	1/2	2 1/4	8 1/2	2 15/16	3 7/16	3 7/16	7 15/16	9 1/8
	4 1/2*	A0187						7								
	5*	A0188						7								
5 1/2*	A0189						7									
10	1 3/4	A1100						4	3/8	1 7/8	9 9/16	2 3/4	3 1/8	3 1/8	8 5/16	10 3/16
	2	A1101						4	3/8	2	9 11/16	2 7/8	3 1/4	3 1/4	9 1/16	10 5/16
	2 1/2	A1102						4								
	3*	A1103						5 1/2								
	3 1/2*	A1104	6 3/8	4 1/8	9	4 1/8	4 5/8	5 1/2								
	4*	A1105						5 1/2	1/2	2 1/4	9 15/16	3 1/8	3 1/2	3 1/2	9 5/16	10 9/16
	4 1/2*	A1106						7								
	5*	A1107						7								
5 1/2*	A1108						7									
12	2	A1120						4	3/8	2	10 3/16	2 7/8	3 1/4	3 1/4	9 9/16	10 13/16
	2 1/2	A1121						4								
	3	A1122						5 1/2								
	3 1/2	A1123						5 1/2								
	4	A1124	6 7/8	4 5/8	9 1/2	4 5/8	5 1/8	5 1/2	1/2	2 1/4	10 7/16	3 1/8	3 1/2	3 1/2	9 13/16	11 1/16
	4 1/2*	A1125						7								
	5*	A1126						7								
5 1/2*	A1127						7									
14	2 1/2*	A1140						4								
	3*	A1141						5 1/2								
	3 1/2*	A1142						5 1/2								
	4*	A1143	8 1/8	5 1/2	11 1/8	5 1/2	5 7/8	5 1/2	1/2	2 1/4	11 7/16	3 3/8	3 13/16	3 13/16	11 3/16	13 5/8
	4 1/2*	A1144						7								
	5*	A1145						7								
5 1/2*	A1146						7									
16	2 1/2*	A1160						4								
	3*	A1161						5 1/2								
	3 1/2*	A1162						5 1/2								
	4*	A1163	8 1/8	5 5/8	12 1/8	5 1/2	5 7/8	5 1/2	1/2	2 1/4	11 7/16	3 3/8	3 13/16	3 3/4	11 3/16	13 1/2
	4 1/2*	A1164						7								
	5*	A1165						7								
5 1/2*	A1166						7									

**HOW TO ORDER**

For ordering information refer to page 98.

**NOTES:**

- ◆ For double rod end cylinders add prefix letter "D" to cylinder code. Example: DA0180. (Refer to page 92.)
- \* Model A43 is not available in these sizes.
- For double rod end cylinders from 8" thru 16" bore, add 1/2" to this dimension (except 10" and 12"; add 1/4").

**Rod End Styles and Dimensions**  
For rod end styles and dimensions see the Table 3 in the inside cover of the catalog.

Page ii

**MilCad Cylinder Configurator**  
Visit [milwaukeekeycylinder.com](http://milwaukeekeycylinder.com) to configure and download CAD files of your cylinders.

**TABLE 2A**

The dimensions are constant regardless of rod diameter or stroke.

Bore Ø	E	EB	EE	EL	EO	ET	F	G	J	K	NT	R	SB	ST	SU	SW	TB	TN	TS	US
8	8 1/2	1 1/16	3/4	1 1/8	5/8	2	-	2	1 1/2	9/16	3/4-10	6.44	1 1/16	1	1 9/16	1 1/16	1 1/8	4 1/2	9 7/8	11 1/4
10	10 5/8	1 3/16	1	1 5/16	5/8	2 5/8	-	2 1/4	2	1 1/16	1-8	7.92	1 1/16	1 1/4	2	7/8	1 5/8	5 1/2	12 3/8	14 1/8
12	12 3/4	1 3/16	1	1 5/16	5/8	3 9/32	-	2 1/4	2	1 1/16	1-8	9.40	1 1/16	1 1/4	2	7/8	1 5/8	7 1/4	14 1/2	16 1/4
14	14 3/4	1 5/16	1 1/4	1 1/2	3/4	3 25/32	-	2 3/4	2 1/4	1 3/16	1 1/4-7	10.90	1 5/16	1 1/2	2 1/2	1 1/8	2 1/4	8 3/8	17	19 1/4
16	17	1 1/16	1 1/4	2	1 1/8	3 5/8	-	2 3/4	2 1/4	1 3/16	1 3/8-6	12.65	1 5/16	1 1/2	2 1/2	1 1/8	2 1/2	9 3/4	19 1/4	21 1/2

Series H

Series MH

Series LH

Series A

**For Package and Mounting**

**Dimension see  
Tables 1A and 2A.**

**PIN AND TRUNNION MOUNTED CYLINDERS**

All pin and trunnion cylinders need a provision on both ends for pivoting. These types of cylinders are designed to carry shear loads and the trunnion and pivot pins should be carried by bearings that are rigidly held and closely fit for the entire length of the pin.

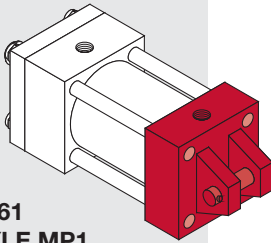

**MODEL A61  
NFPA STYLE MP1**

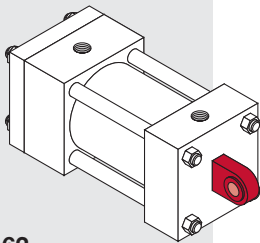
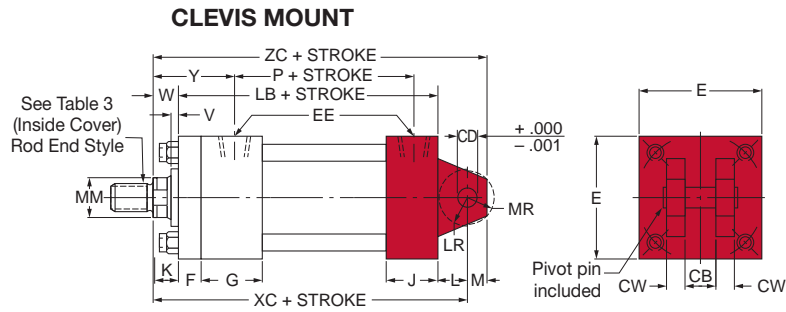

**MODEL A62  
NFPA STYLE MP5**

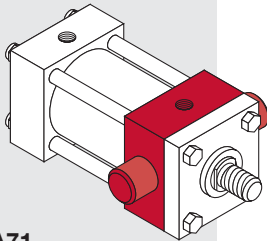
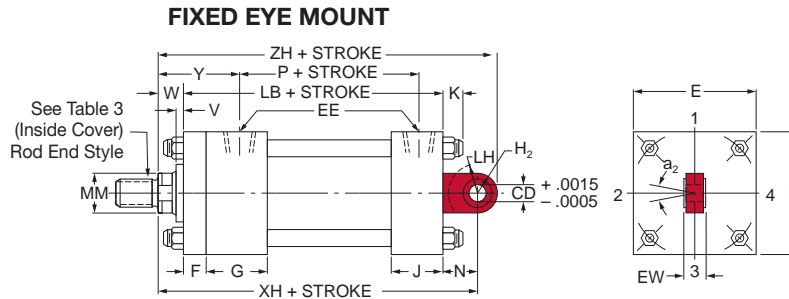

**MODEL A71  
NFPA STYLE MT1**

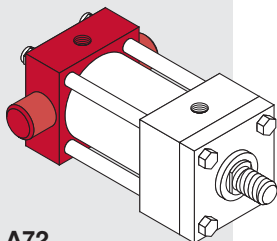
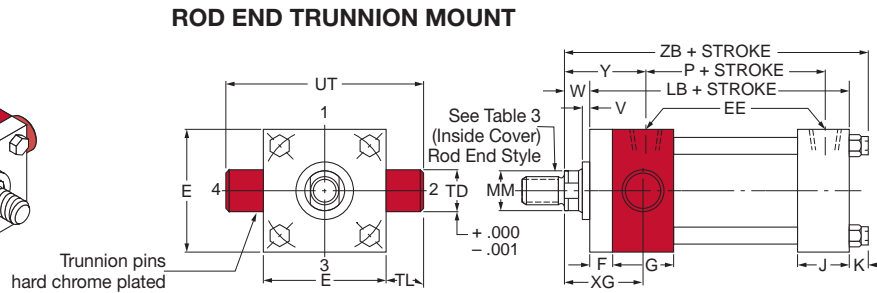

**MODEL A72  
NFPA STYLE MT2**

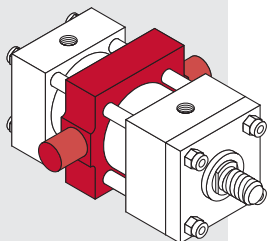
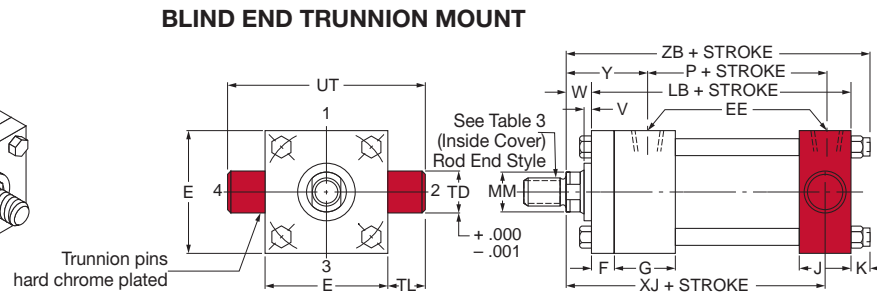

**MODEL A73/A74  
NFPA STYLE MT4**

A73 is an exclusive Milwaukee Cylinder design.  
A74 is the Industry "Standard" design.

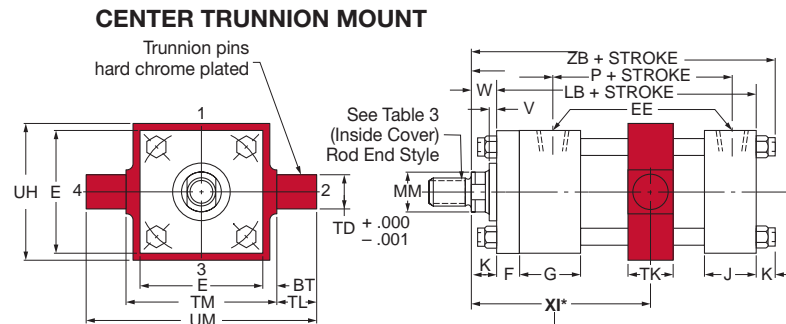

\* Customer to specify XI dimension.

▼ **TABLE 1A**

The dimensions given on this table are affected by the piston rod diameter and the stroke.

Bore Ø	Rod MM	Cylinder Code ♦	LB	P	V	W	XC	XG	XH	XJ	Y	ZB	ZC	ZH
1½	5/8	A0011	4	2¼	¼	5/8	5¾	1¾	5½	4½	115/16	47/8	57/8	6¼
	•1*	A0012			½	1	5¾	2½	57/8	4½	25/16	5¼	6¼	65/8
2	5/8	A0110	4	2¼	¼	5/8	5¾	1¾	5½	4½	115/16	415/16	57/8	6¼
	1*	A0111			½	1	5¾	2½	57/8	4½	25/16	55/16	6¼	65/8
	•1¾*	A0112			5/8	1¼	6	2¾	6½	4¾	29/16	59/16	6½	67/8
2½	5/8	A0120	4½	2¾	¼	5/8	5½	1¾	55/8	4¼	115/16	51/16	6	63/8
	1	A0121			½	1	57/8	2½	6	4¾	25/16	57/16	63/8	6¾
	1¾	A0122			5/8	1¼	6½	2¾	6¼	47/8	29/16	511/16	65/8	7
	•1¾*	A0123			¾	1½	6¾	25/8	6¾	5½	213/16	515/16	67/8	71/8
3¼	1	A0130	47/8	25/8	¼	¾	67/8	2¼	67/8	5	27/16	6	7¾	8½
	1¾	A0131			¾	1	7½	2½	7½	5¼	211/16	6¼	77/8	8¾
	1¾	A0132			½	1¼	7¾	2¾	7¾	5½	215/16	6½	8½	85/8
	2*	A0133			½	1¾	7½	27/8	7½	55/8	31/16	65/8	8¼	8¾
4	1	A0140	47/8	25/8	¼	¾	67/8	2¼	67/8	5	27/16	6	7¾	8½
	1¾	A0141			¾	1	7½	2½	7½	5¼	211/16	6¼	77/8	8¾
	1¾	A0142			½	1¼	7¾	2¾	7¾	5½	215/16	6½	8½	85/8
	2	A0143			½	1¾	7½	27/8	7½	55/8	31/16	65/8	8¼	8¾
	2½*	A0144			5/8	15/8	7¾	3½	7¾	57/8	35/16	67/8	8½	9
5	1	A1x50	5½	27/8	¼	¾	7½	2¼	7½	5¼	27/16	65/16	77/8	8¾
	1¾	A1x51			¾	1	7¾	2½	7¾	5½	211/16	69/16	8½	85/8
	1¾	A1x52			½	1¼	7¾	2¾	7¾	5¾	215/16	613/16	8¾	87/8
	2	A0153			½	1¾	7¾	27/8	7¾	57/8	31/16	615/16	8½	9
	2½	A0154			5/8	15/8	8	3½	8	6½	35/16	73/16	8¾	9¼
	3	A0155			5/8	15/8	8	3½	8	6½	35/16	73/16	8¾	9¼
6	1¾	A0160	5¾	3½	¼	7/8	8½	25/8	8¼	57/8	213/16	71/16	9½	10
	1¾	A0161			¾	1½	8¾	27/8	8½	6½	31/16	75/16	9¾	10¼
	2	A0162			¾	1¼	8½	3	85/8	6¼	33/16	77/16	9½	10¾
	2½	A0163			½	1½	8¾	3¼	87/8	6½	37/16	711/16	9¾	105/8
	3	A0164			½	1½	8¾	3¼	87/8	6½	37/16	711/16	9¾	105/8
	3½	A0165			½	1½	8¾	3¼	87/8	6½	37/16	711/16	9¾	105/8
4	A0166	½	1½	8¾	3¼	87/8	6½	37/16	711/16	9¾	105/8			

For bore diameter sizes 8" to 16" see next page.

**HOW TO ORDER**

For ordering information refer to page 98.

**NOTES:**

- ♦ For double rod end cylinders add prefix letter "D" to cylinder code. Example: DA0011. (Refer to page 92.) Double rod ends are not available on clevis mount Series A cylinders.
- Available with fixed non-adjustable cushions on rod end and standard adjustable cushions on the blind end only.

\* Removable retainer not available for these bore and rod combinations: A61 and A73 mounting styles.



**Rod End Styles and Dimensions**  
For rod end styles and dimensions see the Table 3 in the inside cover of the catalog.

Page ii



**MilCad Cylinder Configurator**  
Visit [milwaukeekeycylinder.com](http://milwaukeekeycylinder.com) to configure and download CAD files of your cylinders.

▼ **TABLE 2A**

The dimensions are constant regardless of rod diameter or stroke.

Bore Ø	a <sub>2</sub>	BT	CB	CD	CW	E	EE	EW	F	G	H <sub>2</sub>	J	K	L	LH	LR	M	MR	N	TD	TL	A73				A74				UT
																						TK	TM	UH	UM	TK	TM	UH	UM	
1½	13°	¾	¾	½	½	2	¾	5/8	¾	1½	13/16	1	¼	¾	5/8	5/8	½	21/32	7/8	1	1	1½	3½	2¾	5½	1¼	2½	2½	4½	4
2	13°	¾	¾	½	½	2½	¾	5/8	¾	1½	13/16	1	5/16	¾	5/8	5/8	½	11/16	7/8	1	1	1½	4	27/8	6	1½	3	3	5	4½
2½	13°	¾	¾	½	½	3	¾	5/8	¾	1½	13/16	1	5/16	¾	5/8	5/8	½	11/16	7/8	1	1	1½	4½	3¾	6½	1½	3½	3½	5½	5
3¼	14°	¾	1¼	¾	5/8	3¾	½	7/8	5/8	1¾	1¼	1¼	¾	1¼	1	11/16	¾	15/16	1¼	1	1	1¼	5¼	4½	7¼	2	4½	4¼	6½	5¾
4	14°	¾	1¼	¾	5/8	4½	½	7/8	5/8	1¾	1¼	1¼	¾	1¼	1	11/16	¾	15/16	1¼	1	1	1¼	6	5	8	2	5¼	5	7¼	6½
5	14°	¾	1¼	¾	5/8	5½	½	7/8	5/8	1¾	1¼	1¼	7/16	1¼	1	11/16	¾	15/16	1¼	1	1	1¼	7	6	9	2	6¼	6	8¼	7½
6	12½°	1	1½	1	¾	6½	¾	1¾	¾	2	1¾	1½	7/16	1½	1¼	1¼	1	13/16	15/8	1¾	1¾	1½	8½	7	11¼	2½	7¾	7	105/8	9¼

Series H

Series MH

Series LH

Series A

## For Package and Mounting

Dimension see  
Tables 1A and 2A.

## PIN AND TRUNNION CYLINDERS

All pin and trunnion cylinders need a provision on both ends for pivoting. These types of cylinders are designed to carry shear loads and the trunnion and pivot pins should be carried by bearings that are rigidly held and closely fit for the entire length of the pin.

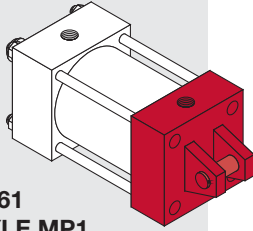

**MODEL A61**  
**NFPA STYLE MP1**

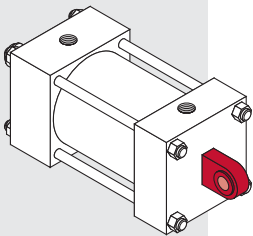
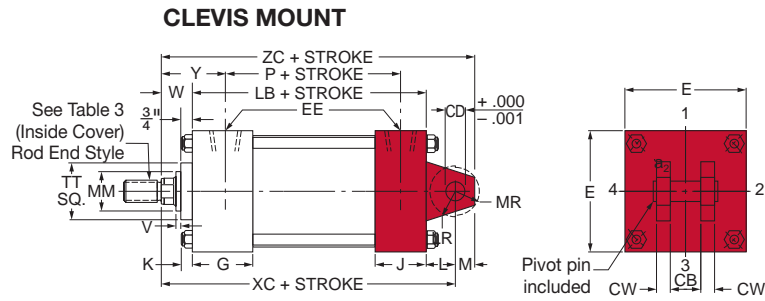

**MODEL A62**

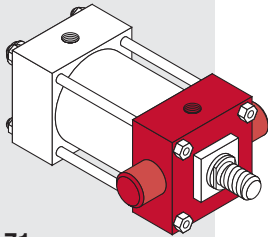
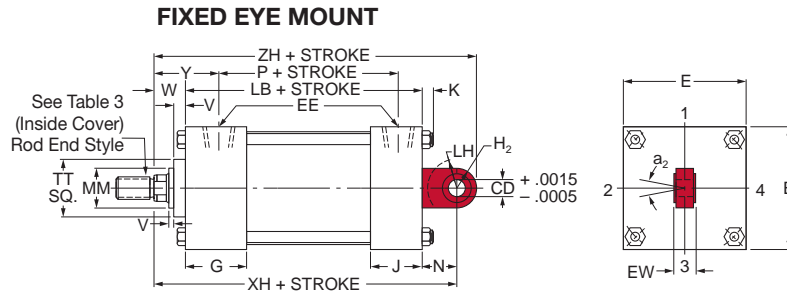

**MODEL A71**  
**NFPA STYLE MT1**

Trunnion pins  
hard chrome plated

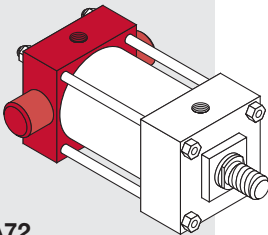
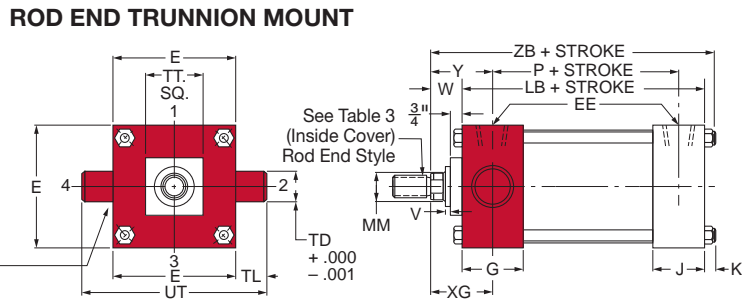

**MODEL A72**  
**NFPA STYLE MT2**

Trunnion pins  
hard chrome plated

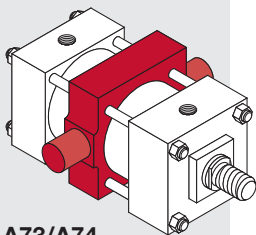
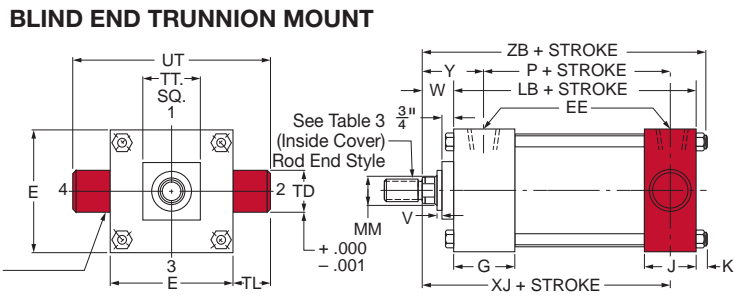

**MODEL A73/A74**  
**NFPA STYLE MT4**

A73 is an exclusive Milwaukee Cylinder design.  
A74 is the Industry "Standard" design.

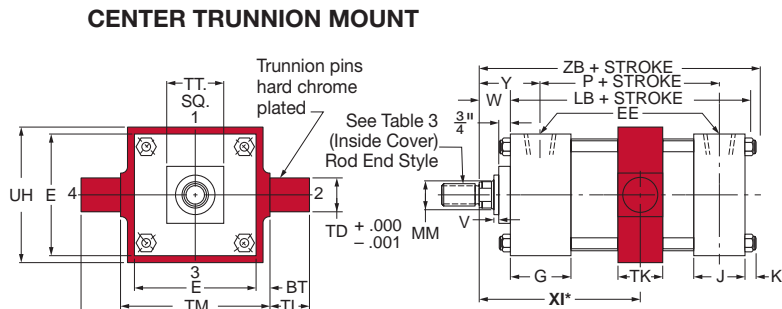

\* Customer to specify XI dimension.

▼ **TABLE 1A**

The dimensions given on this table are affected by the piston rod diameter and the stroke.

Bore Ø	Rod MM	Cylinder Code ♦	LB	P	TT	V	W	XC	XG	XH	XJ	Y	ZB	ZC	ZH
8	1 3/8	A0180	5 1/8	3 1/4	4	1/4	1 5/8	8 1/4	2 5/8	8 3/8	6	2 13/16	7 5/16	9 1/4	10 1/8
	1 3/4	A0181			4	3/8	1 7/8	8 1/2	2 7/8	8 5/8	6 1/4	3 1/16	7 9/16	9 1/2	10 3/8
	2	A0182			4	3/8	2	8 5/8	3	8 3/4	6 3/8	3 3/16	7 11/16	9 5/8	10 1/2
	2 1/2	A0183			4										
	3	A0184			5 1/2										
	3 1/2	A0185			5 1/2										
	4	A0186			5 1/2	1/2	2 1/4	8 7/8	3 1/4	9	6 5/8	3 7/16	7 15/16	9 7/8	10 3/4
	4 1/2	A0187			7										
5	A0188	7													
5 1/2	A0189	7													
10	1 3/4	A1100	6 3/8	4 1/8	4	3/8	1 7/8	10 3/8	3	-	7 1/4	3 3/8	8 15/16	11 3/4	-
	2	A1101			4	3/8	2	10 1/2	3 1/8	-	7 3/8	3 1/4	9 1/16	11 7/8	-
	2 1/2	A1102			4										
	3	A1103			5 1/2										
	3 1/2	A1104			5 1/2										
	4	A1105			5 1/2	1/2	2 1/4	10 3/4	3 3/8	-	7 5/8	3 1/2	9 5/16	12 1/8	-
	4 1/2	A1106			7										
	5	A1107			7										
5 1/2	A1108	7													
12	2	A1120	6 7/8	4 5/8	4	3/8	2	11 1/8	3 1/8	-	7 7/8	3 3/4	9 9/16	12 7/8	-
	2 1/2	A1121			4										
	3	A1122			5 1/2										
	3 1/2	A1103			5 1/2										
	4	A1124			5 1/2	1/2	2 1/4	11 3/8	3 3/8	-	8 1/8	3 1/2	9 13/16	13 1/8	-
	4 1/2	A1125			7										
	5	A1126			7										
5 1/2	A1127	7													
14	2 1/2	A1140	8 1/8	5 1/2	4										
	3	A1141			5 1/2										
	3 1/2	A1142			5 1/2										
	4	A1143			5 1/2	1/2	2 1/4	12 7/8	3 5/8	-	9 1/4	3 13/16	11 3/16	14 7/8	-
	4 1/2	A1144			7										
	5	A1145			7										
5 1/2	A1146	7													
16	2 1/2	A1160	8 1/8	5 5/8	4										
	3	A1161			5 1/2										
	3 1/2	A1162			5 1/2										
	4	A1163			5 1/2	1/2	2 1/4	14 3/8	3 5/8	-	9 1/4	3 3/4	11 3/16	16 7/8	-
	4 1/2	A1164			7										
	5	A1165			7										
5 1/2	A1166	7													

**HOW TO ORDER**

For ordering information refer to page 98.

**NOTES:**

- ♦ For double rod end cylinders add prefix letter "D" to cylinder code. Example: DA0180. (Refer to page 92.) Double rod ends are not available on clevis mount Series A cylinders.

**i Rod End Styles and Dimensions**  
For rod end styles and dimensions see the Table 3 in the inside cover of the catalog.  
Page ii

**MilCad Cylinder Configurator**  
Visit [milwaukeekeycylinder.com](http://milwaukeekeycylinder.com) to configure and download CAD files of your cylinders.

▼ **TABLE 2A**

The dimensions are constant regardless of rod diameter or stroke.

Bore Ø	a <sub>2</sub>	BT	CB	CD	CW	E	EE	EW	G	H <sub>2</sub>	J	K	L	LH	LR	M	MR	N	TD	TL	A73				A74				UT
																					TK	TM	UH	UM	TK	TM	UH	UM	
8	12 1/2°	1	1 1/2	1	3/4	8 1/2	3/4	1 3/8	2	1 3/4	1 1/2	9/16	1 1/2	1 1/4	1 1/4	1	1 3/16	1 5/8	1 3/8	1 3/8	1 1/2	10 1/2	9	13 1/4	2 1/2	9 3/4	9 1/2	12 1/2	11 1/4
10	-	1 1/4	2	1 3/8	1	10 5/8	1	-	2 1/4	-	2	1 1/16	2 1/8	-	2 7/8	1 3/8	1 3/8	-	1 3/4	1 3/4	2	13 1/8	11	16 5/8	3	12	11 3/4	15 1/2	14 1/8
12	-	1 1/4	2 1/2	1 3/4	1 1/4	12 3/4	1	-	2 1/4	-	2	1 1/16	2 1/4	-	2	1 3/4	1 3/4	-	1 3/4	1 3/4	2	15 1/4	13 3/8	18 3/4	3	14	17 1/2	18 3/4	16 1/4
14	-	1 1/2	2 1/2	2	1 1/4	14 3/4	1 1/4	-	2 3/4	-	2 1/4	1 3/16	2 1/2	-	2 1/4	2	2	-	2	2	2 1/4	17 3/4	15 3/8	21 3/4	3 1/2	16 1/4	16	20 1/4	18 3/4
16	-	1 1/2	3	2	1 1/4	17	1 1/4	-	2 3/4	-	2 1/4	1 3/16	4	-	3 5/8	2 1/2	3	-	2	2	2 1/4	20	18	24	-	-	-	-	-

Series H

Series MH

Series LH

Series A

### DOUBLE ROD END CYLINDERS

Milwaukee Cylinder's Double Rod End Cylinders are available with all the standard types of mountings, except 61 and 62.

To obtain dimensioning information on a double rod end cylinder, first select the desired mounting style and refer to the corresponding single rod end cylinder model shown on the preceding pages. After you have determined all necessary dimensions from the previous page covering the desired mounting, turn back to this page.

Supplement those dimensions with additional ones from the drawings below and the table on the right. These added dimensions differ from, or are in addition to, those shown on the preceding pages and provide the additional information needed to completely dimension a double rod end cylinder model.

On a double rod end cylinder where two different rod ends are required, or two different rod sizes are required, or cushions on one end are required, be sure to state clearly which rod is to go at which end of the cylinder. When two types of mounting styles are required, be sure to specify their relationship to the piston rods if they are not the same.

1½ Thru 6" Mount

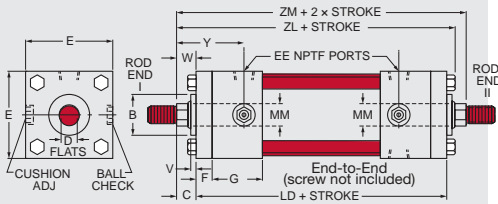

8 Thru 16" Mount

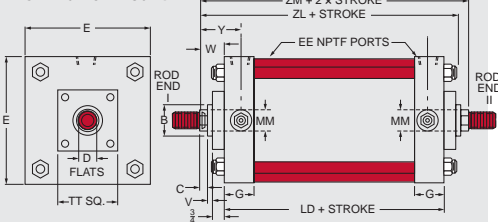

Bore Ø	Rod MM	Cylinder Code	LD*	SE*	SS*	ZL	ZM
1½	5/8	DA0011	47/8	63/8	33/8	53/4	61/8
	1	DA0012				61/8	67/8
2	5/8	DA0110	47/8	63/4	33/8	513/16	61/8
	1	DA0111				63/16	67/8
	13/8	DA0112				67/16	73/8
2½	5/8	DA0120	5	71/8	31/2	515/16	61/4
	1	DA0121				65/16	7
	13/8	DA0122				69/16	71/2
	13/4	DA0123				613/16	8
3¼	1	DA0130	6	73/4	33/4	71/8	71/2
	13/8	DA0131				73/8	8
	13/4	DA0132				73/8	81/2
	2	DA0133				73/4	83/4
4	1	DA0140	6	8	33/4	71/8	71/2
	13/8	DA0141				73/8	8
	13/4	DA0142				73/8	81/2
	2	DA0143				73/4	83/4
	2½	DA0144				8	9¼
5	1	DA1x50	6¼	83/8	35/8	77/16	73/4
	13/8	DA1x51				711/16	8¼
	13/4	DA1x52				715/16	83/4
	2	DA0153				81/16	9
	2½	DA0154				85/16	9½
	3	DA0155					
3½	DA0156						
6	13/8	DA0160	7	83/8	41/8	85/16	83/4
	13/4	DA0161				83/16	9¼
	2	DA0162				811/16	9½
	2½	DA0163				815/16	10
	3	DA0164					
	3½	DA0165					
4	DA0166						
8	13/8	DA0180	55/8	77/8	4¼	713/16	83/8
	13/4	DA0181				81/16	93/8
	2	DA0182				83/16	93/8
	2½	DA0183				87/16	101/8
	3	DA0184					
	3½	DA0185					
	4	DA0186					
	4½	DA0187					
	5	DA0188					
5½	DA0189						
10	13/4	DA1100	63/8	9¼	47/8	93/16	103/8
	2	DA1101				95/16	105/8
	2½	DA1102				99/16	111/8
	3	DA1103					
	3½	DA1104					
	4	DA1105					
	4½	DA1106					
	5	DA1107					
5½	DA1108						
12	2	DA1120	71/8	93/4	53/8	93/16	111/8
	2½	DA1121				101/16	113/8
	3	DA1122					
	3½	DA1123					
	4	DA1124					
	4½	DA1125					
	5	DA1126					
5½	DA1127						
14	2½	DA1140	83/8	115/8	63/8	1111/16	133/8
	3	DA1141					
	3½	DA1142					
	4	DA1143					
	4½	DA1144					
	5	DA1145					
5½	DA1146						
16	2½	DA1160	83/8	113/4	63/8	1111/16	133/8
	3	DA1161					
	3½	DA1162					
	4	DA1163					
	4½	DA1164					
	5	DA1165					
5½	DA1166						

\*Note: These dimensions are to be substituted for the related mounting dimensions given on the preceding pages. All dimensions given on this table are plus stroke.

**KEY MOUNT CYLINDERS**

The *Milwaukee Cylinder* Key Mount retainer plate is a mounting option designed to add rugged stability to foot and side mount cylinders. The retainer plate is extended below the mounting surface of the cylinder. This extension may be fitted into a milled keyway in your mounting pad, eliminating the need for welded keys or locator pins.

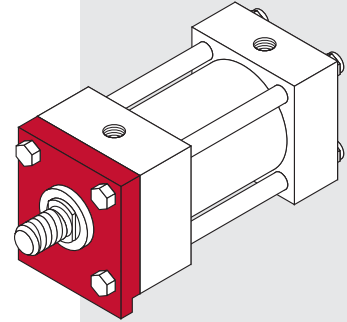
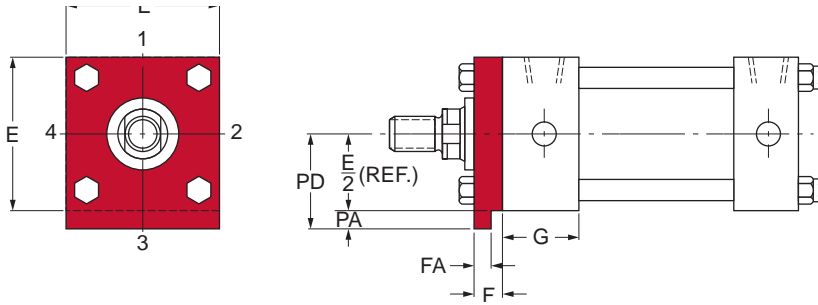

▼ **KEY MOUNT CYLINDERS**

Bore Ø	E	F	FA	G	PA	PD
1½	2	⅜	.312/.310	1½	⅜	1⅜
2	2½	⅜	.312/.310	1½	⅜	1⅞
2½	3	⅜	.312/.310	1½	⅜	1⅞
3¼	3¾	⅝	.562/.560	1¼	⅝	2¾
4	4½	⅝	.562/.560	1¼	⅝	2⅞
5	5½	⅝	.562/.560	1¼	⅝	3⅞
6	6½	¾	.687/.684	2	¾	3⅝

**HOW TO ORDER**  
For ordering information refer to page 98.

Series A

Series MN

Hyd-Pneum Devices

Cyl Accessories

Manipulators

Power Units/Valves

Design Guide



Series H

Series MH

Series LH

Series A

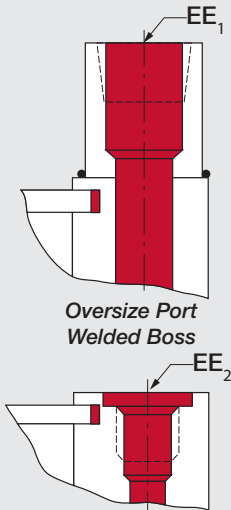

Oversize Port  
Welded Boss

SAE Straight Thread  
O-ring Port

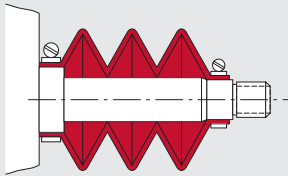

Rod Boots

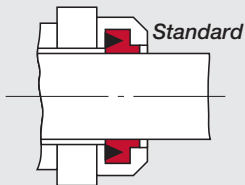

Standard

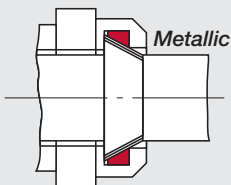

Metallic

Metallic Rod Wipers



**MilCad Cylinder  
Configurator**

Visit [milwaukeecylinder.com](http://milwaukeecylinder.com)  
to configure and download  
CAD files of your cylinders.

## DESIGN OPTIONS

### Standard Ports

The *Milwaukee Cylinder* Series A Cylinders are manufactured as standard, the largest NPTF tapered thread ports that will fit in both the rod and blind ends of a given bore size. Upon request, extra ports can be provided on the sides of the end caps not occupied by mountings or cushion adjusters.

### Oversize Ports

On most bore sizes, welded bosses may be provided for oversize NPTF ports. These bosses protrude from the sides of the end caps. For information as to the boss height in relation to your bore and port requirements, contact your local *Milwaukee Cylinder* Representative. Also, special heavier end caps can be provided so that oversize ports can be accommodated without the use of a welded boss.

### Straight Thread Ports

On request, *Milwaukee Cylinder* will furnish an SAE straight thread O-Ring port on the Series A Cylinders. In addition to the standard oversize NPTF ports, welded bosses may also be used for oversize SAE straight thread O-Ring ports. For further information on oversize SAE ports, contact the factory.

**Note:** Flange and manifold style ports are available from *Milwaukee Cylinder*.

### Rod Boots

When cylinders are used in areas of high contamination or where contaminants have an air hardening property, the exposed piston rod should be covered with a rod boot to protect the rod bearing and seals. A rod boot is simply a collapsible cover. It is of sewn construction made from a neoprene coated fabric. The rod boots are impervious to oil, grease and water. They will operate effectively from 0°F to +200°F without cracking. For additional details on Rod Boots, please see page 186.

### Metallic Rod Wipers

If requested, metallic rod wipers will be supplied in place of the standard synthetic rubber wiper. This type of seal is recommended for applications where contaminants would tend to cling to the rod and damage a standard synthetic rubber rod wiper.

## ▼ PORT SIZES

Bore Ø	Standard NPTF Port EE	Oversized NPTF Port EE <sub>1</sub>	SAE Straight O-Ring Port EE <sub>2</sub>	SAE Standard Thread Series
1½	¾	½	#6	¾-18
2	¾	½	#6	¾-18
2½	¾	½	#6	¾-18
3¼	½	¾	#10	7/8-14
4	½	¾	#10	7/8-14
5	½	¾	#10	7/8-14
6	¾	1	#12	1½-12
8	¾	1	#12	1½-12
10	1	1¼	#16	1½-12
12	1	1¼	#16	1½-12
14	1¼	1½	#20	1½-12
16	1¼	1½	#20	1½-12

## DESIGN OPTIONS FOR SPECIAL CYLINDERS

### Special Rod Ends

Modifications of standard or entirely special rod ends are available from *Milwaukee Cylinder*. When your requirements call for a special rod end style, your order should include a sketch if it is to be an entirely special rod end or note reference as to which letter dimensions you wish to have modified (see inside front cover).

### Special Assemblies from Standard Parts

Each style of the various standard cylinder mountings is illustrated, using the commonly recognized cylinder dimensional symbols of the National Fluid Power Association. Each side of the end views are numbered to aid in communication when referring to the relationship between the ports and the mountings. When requesting information or placing an order that requires a dimension other than standard, always make reference to the given dimensional symbol in the catalog and then give your requirements.

### Cushion Adjustment Locations

A ball check is supplied as standard in position #2 and a cushion adjustment needle is supplied **as standard in position #2 on most models**. The cushion needle and ball check are interchangeable as far as location and may be put in any side not occupied by a port or mounting.

### Port Locations

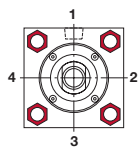

Ports are located in position #1 as standard unless otherwise specified. By using the position numbers given with the end views in the dimensional data section of this catalog, ports can be arranged in any one of four 90° positions in relation to the cylinder mounting. When ports are relocated on a cushioned cylinder, the cushion needle and ball check are automatically relocated to hold their relationship to the port as on a standard cylinder, unless otherwise specified at the time of the order.

### Removable Trunnion Pins

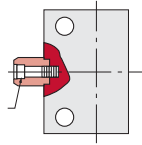

Removable trunnion pins are available on models A71 and A72. They can be used on all bore and rod combinations, except on the largest oversize rods offered with each bore size on all model A71 cylinders.

### Single-Acting Cylinders

The *Milwaukee Cylinder Series A* Cylinders are designed for either single- or double action. When used as a single-acting cylinder, pneumatic power drives the piston in one direction, only relying on either the load or an external force to return the piston after the pressure is exhausted.

### Single-Acting Spring Cylinders

Single-acting spring return cylinders normally have a spring inside of the cylinder to return the piston to its original position. The application load and friction conditions must be specified when placing an order to properly size the spring. Also specify whether the spring is to return or advance the piston. A spring return cylinder is designed with a stop tube to act as spring guide, which prevents binding of the cylinder due to misalignment of the spring. To accurately determine the cylinder length and mounting dimensions for your application, contact your local *Milwaukee Cylinder* representative or the factory.

### Proximity Switches

#### End of Stroke Limit Switches:

We provide inductive proximity switches for end of stroke sensing. These non-contact switches detect the presence of the spud/cushion bushing. See page 185 for more information.

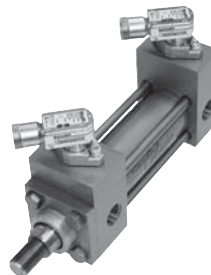

### Combined Mountings

Standard mountings may be combined when specified by the customer. Some examples of this are:

▼ An A31 mount constructed with an A42 mount blind end cap.

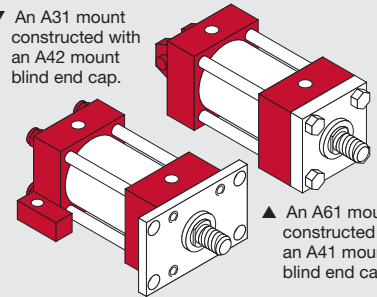

▲ An A61 mount constructed with an A41 mount blind end cap.

These and other combinations can be readily made from standard parts. If you are unsure of a possible combination or if it will suit your particular needs, consult with your local *Milwaukee Cylinder* representative or contact the factory.

### Adjustable Stroke Cylinders

When a cylinder application requires stroke adjustment, *Milwaukee Cylinder* offers a number of designs. This particular design is externally adjustable, incorporating a threaded rod (of piston rod quality) with a seal nut. This provides a proven-effective, high and low pressure seal, affording maximum sealing on the stroke adjustment rod.

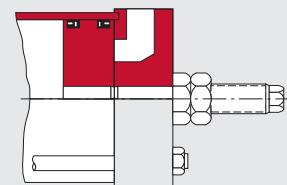

Further information concerning design limitations, cushioning or alternate designs can be obtained by contacting *Milwaukee Cylinder*.

**CAUTION!**

Cylinders with removable trunnion pins will have a reduced pressure rating. Consult the factory.

## ▼ FIGURE 1

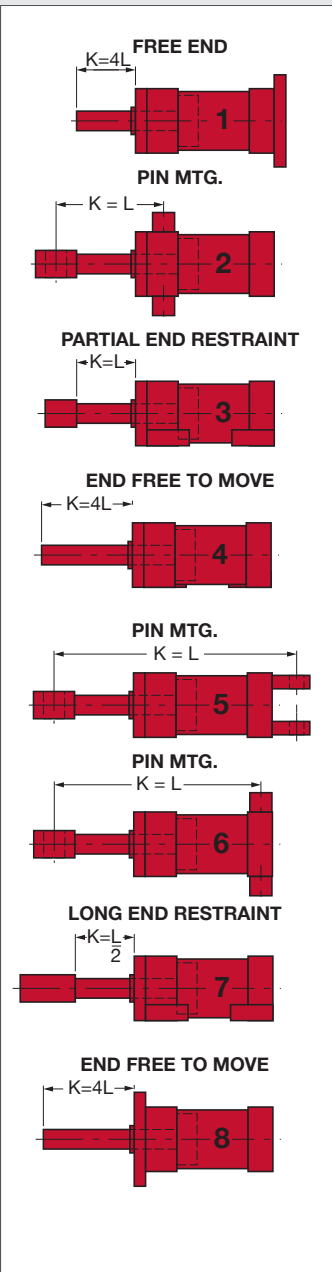

**Stop Tubes**  
For more information on Stop Tubes, see page 181 in the Design Engineer's Guide.

## STOP TUBES

Stop tubes are used to maintain bearing pressure within acceptable limits and are recommended on cylinders with long strokes or poorly guided rods.

The stop tube is a spacer between the rod end cap and the piston, which provides separation between the piston and the rod bearing. This separation reduces the moment forces developed between the rod bearing and piston when the rod is extended.

Depending on the type of air cylinder you require, *Milwaukee Cylinder* offers two stop tube designs. When an air cylinder cushioned on the rod end requires stop tube, an additional piston and spacer is used (refer to Figure A). If an air cylinder requiring stop tube is not cushioned, only a spacer is used (refer to Figure B).

To determine if stop tube is necessary for your cylinder requirements, you have to solve for "K" (refer to Figure 1). If your required cylinder has a "K" dimension in excess of 40 inches, stop tube is required. For each 10 inch increment or fraction thereof in excess of 40 inches, one inch of stop tube is recommended. When stop tube is required, the overall length of the cylinder will be increased by the length of the stop tube to be used.

To determine "K" (see Figure 1)

\*Note: W = the rod stick out (refer to pages 74-93)

$$K = 4L = 4(\text{stroke} + W^*)$$

### Cylinder #2 - see Figure 1

$$K = L = (CA \text{ or } CE) + XG + \text{Stroke}$$

Note:

CA = rod eye dimension (back inside cover)

CE = rod clevis dimension (back inside cover)

XG = mounting dimension page 88 or 90

### Cylinder #3 - see Figure 1

$$K = L = W^* + \text{Stroke}$$

### Cylinder #5 - see Figure 1

$$K = L = (CA \text{ or } CE) + XC + (2 \times \text{Stroke})$$

Note:

CA = rod eye dimension (back inside cover)

CE = rod clevis dimension (back inside cover)

XC = mounting dimension page 88 or 90

### Cylinder #6 - see Figure 1

$$K = L = (CA \text{ or } CE) + XJ + (2 \times \text{Stroke})$$

Note:

CA = rod eye dimension (back inside cover)

CE = rod clevis dimension (back inside cover)

XJ = mounting dimension page 88 or 90

### Cylinder #7 - see Figure 1

$$K = L/2 = (W^* + \text{Stroke})/2$$

When mounting long stroke cylinders, care should be taken to assure cylinder alignment over the entire length of stroke. The use of external guides or swivel bushings is recommended to reduce side load conditions and prolong the cylinder's service life.

**Note:** Stop tube length must be added to "K" factor before making final selection of rod size. This is primarily true in No. 5 long stroke applications.

Figure A

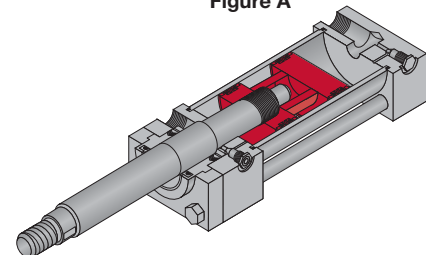
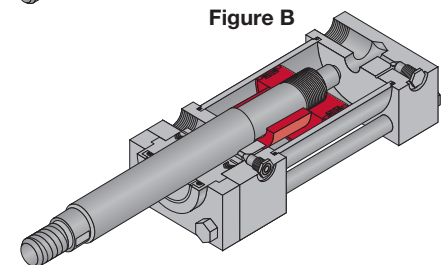

Figure B



*The stop tube is located between the piston and the rod end cap. It limits the extended stroke of the cylinder, providing additional strength for less cost and reduced weight than the use of an oversize rod.*

▼ **TABLE 1 - VALUE OF "K" IN INCHES**

Thrust Force (in-lbs)	Piston Rod Diameter (in)													
	5/8	1	1 1/8	1 1/4	2	2 1/2	3	3 1/2	4	4 1/2	5	5 1/2	7	
400	35	84	134	-	-	-	-	-	-	-	-	-	-	-
700	30	68	119	-	-	-	-	-	-	-	-	-	-	-
1,000	26	60	105	156	190	-	-	-	-	-	-	-	-	-
1,400	24	54	93	144	175	244	308	-	-	-	-	-	-	-
1,800	23	48	84	127	160	230	294	366	-	-	-	-	-	-
2,400	18	45	75	114	145	214	281	347	-	-	-	-	-	-
3,200	16	40	68	103	131	196	262	329	398	-	-	-	-	-
4,000	12	38	63	93	119	174	240	310	373	446	-	-	-	-
5,000	9	36	60	87	112	163	225	289	359	426	-	-	-	-
6,000	-	30	56	82	102	152	209	274	342	411	476	-	-	-
8,000	-	25	51	76	93	136	186	244	310	375	448	-	-	-
10,000	-	21	45	70	89	125	172	221	279	349	412	-	-	-
12,000	-	17	41	64	85	117	155	210	270	326	388	455	-	-
16,000	-	-	35	57	75	110	141	188	233	291	350	421	-	-
20,000	-	-	28	52	66	103	136	173	218	270	325	385	-	-
30,000	-	-	-	39	56	87	120	156	190	232	285	330	-	-
40,000	-	-	-	24	43	75	108	142	177	210	248	293	-	-
50,000	-	-	-	-	30	66	97	131	165	201	234	268	408	-
60,000	-	-	-	-	-	57	88	119	154	190	226	256	384	-
80,000	-	-	-	-	-	36	71	104	136	170	204	240	336	-
100,000	-	-	-	-	-	-	56	91	120	154	199	224	324	-
120,000	-	-	-	-	-	-	45	76	108	146	174	207	313	-
140,000	-	-	-	-	-	-	-	64	98	129	162	194	301	-
160,000	-	-	-	-	-	-	-	47	87	118	149	182	279	-
200,000	-	-	-	-	-	-	-	-	65	98	131	160	260	-
250,000	-	-	-	-	-	-	-	-	-	72	109	143	236	-
300,000	-	-	-	-	-	-	-	-	-	-	85	120	212	-
350,000	-	-	-	-	-	-	-	-	-	-	53	100	195	-
400,000	-	-	-	-	-	-	-	-	-	-	-	72	182	-
500,000	-	-	-	-	-	-	-	-	-	-	-	-	152	-
600,000	-	-	-	-	-	-	-	-	-	-	-	-	-	114
700,000	-	-	-	-	-	-	-	-	-	-	-	-	-	70

▼ **TABLE 2 - DEDUCTIONS FOR PULL STROKE FORCE & DISPLACEMENT**

Bore Ø	Piston Rod Area	Piston Rod Force in Pounds for Various Pressures								Displacement per inch of Stroke	
		30 psi	50 psi	80 psi	100 psi	125 psi	150 psi	200 psi	250 psi	Pressure Air Cubic Ft. Displaced	Free Air Cubic Ft. @ 80 psi
5/8	.307	9	15	25	31	38	46	62	77	.00018	.00116
1	.785	23	39	63	79	98	118	158	197	.00045	.00290
1 1/8	1.4895	44	74	119	149	186	223	298	372	.00086	.00554
1 1/4	2.405	72	120	192	241	300	261	482	601	.00139	.00895
2	3.142	94	157	251	314	392	471	628	785	.00182	.01172
2 1/2	4.909	147	245	393	491	613	736	982	1227	.00284	.01829
3	7.069	212	353	566	707	883	1060	1414	1767	.00409	.02635
3 1/2	9.621	288	481	770	962	1202	1443	1924	2405	.00557	.03588
4	12.566	377	628	1006	1257	1571	1885	2514	3142	.00727	.04683
4 1/2	15.904	477	795	1272	1590	1987	2385	3180	3975	.00920	.05926
5	19.635	589	982	1571	1964	2455	2946	3928	4910	.01137	.07324
5 1/2	23.758	712	1188	1901	2376	2970	3564	4752	5940	.01375	.08857

▼ **TABLE 3 - THRUST FORCE AND DISPLACEMENT**

Piston Ø	Piston Rod Area	Cylinder Force in Pounds for Various Pressures								Displacement per inch of Stroke	
		30 psi	50 psi	80 psi	100 psi	125 psi	150 psi	200 psi	250 psi	Pressure Air Cubic Ft. Displaced	Free Air Cubic Ft. @ 80 psi
1 1/2	1.77	53	88	141	177	221	265	354	442	.00102	.00657
2	3.14	94	157	251	314	392	471	628	785	.00182	.01185
2 1/2	4.91	147	245	393	491	613	736	982	1227	.00284	.01829
3 1/4	8.30	249	415	664	830	1037	1245	1660	2075	.00480	.03091
4	12.57	377	628	1006	1257	1571	1885	2514	3142	.00727	.04682
5	19.64	589	982	1571	1964	2455	2946	3928	4910	.01137	.07324
6	28.27	848	1413	2262	2827	3533	4240	5654	7067	.01636	.10538
8	50.27	1508	2513	4022	5027	6283	7540	10054	12567	.02909	.18740
10	78.54	2356	3927	6283	7854	9817	11781	15708	19635	.04545	.29279
12	113.10	3393	5655	9048	11310	14137	16965	22620	28275	.06545	.42160
14	153.90	4617	7695	12312	15390	19237	23085	30780	38475	.08906	.57367
16	201.10	6030	10050	16080	20100	25125	30150	40200	50250	.11620	.74900

**CYLINDER SIZING**

The selection of the correct rod size is one of the most important factors in sizing a cylinder. The standard rod for each bore size that *Milwaukee Cylinder* manufactures is sufficient to handle the maximum tension force that the cylinder is capable of producing. It is primarily in compression and long stroke, high thrust applications that the column strength needs to be considered.

The following steps should be used to determine the proper rod size for an application:

1. Select the cylinder bore size required from Table 3 based on the required cylinder thrust force and the operating line pressure at the cylinder.
2. Determine the length between mounting points or "L" as shown on Figure 1, page 96.
3. Based on the distance between mounting points ("L"), determine the value of "K" as shown on Figure 1, page 96.
4. Using the thrust force and the developed "K" dimension, refer to Table 1 to select the proper rod size.
5. If an oversized rod is required, re-check the overall length dimension ("K") in Step 1 and confirm your previous rod size selection.

To determine the cylinder pull (tension), stroke force, or displacement, deduct the force or displacement corresponding to the rod size in Table 2 from the force or displacement corresponding to the bore size shown in Table 3.

Series H

Series MH

Series LH

Series A

Feature	Description	Page Number	Code Number	Example
Double Rod End		92	D	A143 - 31 - 1 4 - - 7 x 14 <sup>3</sup> / <sub>4</sub>
Cylinder Code	Refer to TABLE 1A	77, 79, 81, 83, 85, 87, 89, 91	—	
Mounting Style	Model Number Only	76, 78, 80, 82, 84, 86, 88, 90	—	
Rod End Style	Code Number	inside front cover (ii)	—	
Cushions	None Rod End Blind End Both Ends	— — — —	1 2 3 4	
Cylinder Modifications	Special		S	If Standard Leave Blank
Seals	Buna-N (-20° to 200° F) Viton (-15° to 350° F) Special		7 8 S	*If Special Describe Requirements
Stroke	Specify in Inches Including Fractional Requirements		—	

**\*NOTE:** Use "S" if any special design features or seals are required, describe in detail on your order.

**EXAMPLE:** The code for a pneumatic cylinder 4" bore, rod end rectangular flange mounting, 1<sup>3</sup>/<sub>4</sub>" rod, Style No. 1 rod end, cushion both ends, standard seals with a 14<sup>3</sup>/<sub>4</sub>" stroke is **A142-31-14-7x14<sup>3</sup>/<sub>4</sub>**.

## HOW TO ORDER

### Series A Cylinders

Standard Series A Cylinders can be completely and accurately described by a model number. If your requirements are completely standard, select the alphanumeric codes from above that represent your cylinder and place them in the sequence indicated by the example. Use of the cylinder model number will eliminate untimely delays in handling your order.

#### General Order Data

(covered by the cylinder code)

1. Bore & Rod Size or the Cylinder Code: (refer to pages 76-93)
2. Mounting Style: (refer to page 76-93)
3. Rod End Style: (refer to Inside Cover, page ii)
4. Cushion Requirements
5. Length of Stroke

### Application Data

1. **Port Requirements:** refer to page 94.
2. **Operating Fluid or Medium:** Series A Cylinders are equipped with seals for use with shop air or petroleum base fluids. Specify on your order if any other type of operating medium is to be used.
3. **Temperature Range:** Series A pneumatic cylinders contain seals of Nitrile (Buna-N) suitable to -20° F to +200° F. Specify your operating temperature if your application does not fall within this temperature range.
4. **Operating Pressure:** Series A Cylinders are rated for 250 psi. If your requirements are in excess of the rated pressure, describe your application in your order.
5. **Accessories:** Specify any accessories you require, using the part numbers given on the inside back cover.
6. **Special Requirements:** If you require special seals, rod material, stop tube, center support, adjustable stroke or any other special requirements not covered, specify in detail on your order.



### DUPLICATE CYLINDERS

Duplicate cylinders can be ordered by giving the serial number from the nameplate of the original cylinder. Factory records supply a quick, positive identification.



### MilCad Cylinder Configurator

Visit [milwaukeeecylinder.com](http://milwaukeeecylinder.com) to configure and download CAD files of your cylinders.



## REPLACEMENT SEALS OR CYLINDER PARTS

For replacement seals or cylinder parts, the serial number of your cylinder, the cylinder model number and the item number of the part you require (below) should appear on your order. To order entire seal kits for your cylinder, simply specify the serial number and the cylinder model number from page 84 on your request for service parts.

## HOW TO ORDER COMPLETE SEAL KITS

When ordering complete seal kits, specify the following information on your order:

1. The serial number of the cylinder the seals will be used on.
2. The bore and rod size.
3. If the cylinder is cushioned.

To eliminate untimely delays in the handling of your order, please use the seal kit code as shown in the example below:

Example:

**Buna-N Kit No.** XXXXX-7-50

- cylinder code number (refer to pages 76-93)

**Viton Kit No.** XXXXX-8-50

- cylinder code number (refer to pages 76-93)

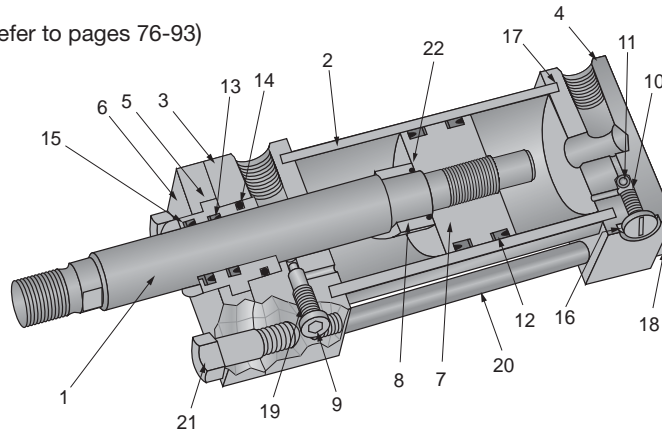

Item No.	Description
1	Piston Rod
2	Cylinder Barrel
3	Head End Cap
4	Cap End Cap
5	Rod Bushing
6	Retainer Plate
7	Piston
8	Cushion Plunger
9	Cushion Adj. Needle
10	Ball Check Retainer
11	Ball Check
12	U-Cup Seal & Backup Washer for Piston
13	Rod Seal & Backup Washer for Rod Bushing
14	O-Ring Seal for Rod Bushing
15	Rod Wiper
16	O-Ring Seal for Ball Check Retainer
17	Gasket
18	Tie Rod Nut
19	O-Ring Seal for Cushion Adj. Needle
20	Tie Rod
21	Self-Locking Cap Screw
22	O-Ring for Floating Cushion

## Retainer Plate Cap Screw Torques

### ▼ For Square Retainers

Bore Ø	Torque (Ft-lbs)
1½	10
2	20
2½	20
3¼	30
4	30
5	50
6	50

## Tie-rod Nut Torques

### ▼ Nut Torque Specifications

Bore Ø	Torque (Ft-lbs)	
	Steel	Composite
1½	5	3
2-2½	12	6
3¼-4	30	15
5-6	50	25
8	100	50
10	160	95
12	160	135
14	250	220
16	250	250

When it is necessary to remove the tie-rod nuts on a cylinder, they must be reassembled to the torque specifications given above. To prevent the tie-rods from twisting when tightened, use a vice grip or locking clamp. Note that the torque specification is based on lubricated threads.

**INSTALLATION FOR SERIES A****General Information****Cleanliness**

Cleanliness is the most important consideration when installing the cylinder. When cylinders are shipped from *Milwaukee Cylinder*, the ports are securely plugged with plastic plugs which should not be removed until the piping is to be installed. All piping should be thoroughly clean, to include the removal of all threading and flaring burrs or chips, before making the connection to the cylinder ports. One chip can cause premature failure of the cylinder or other system components.

**Alignment**

Improper alignment will result in excessive cylinder wear. Check to assure rod alignment between the cylinder and its mating component on your machine in both the extended and retracted positions.

**Environment**

Cylinders operating in areas where there is weld splatter, fast drying chemicals, paint, excessive heat or other hazardous conditions, should have covers or shields to prevent damage to the rod and rod seals.

**MOUNTING RECOMMENDATIONS****Foot Mounted Cylinders**

The use of high-strength alloy steel mounting bolts 1/16" smaller than the hole size is recommended. After final alignment, foot mounted cylinders should be dowel pinned in place.

**Trunnion Mounted Cylinders**

Lubricated pillow blocks designed for close tolerance applications should be used. It is important to rigidly mount and align the pillow blocks so that the trunnion pins will not be subjected to any extreme bending moments. The rod end should be pivoted with the pivot pin in line and parallel to the axis of the trunnion pins.

**Flush Mount Cylinders**

The use of high strength alloy steel mounting bolts is recommended. Shear keys should be used to reduce the stress on the mounting bolts created by the normal push and pull forces created by the cylinder cycle.

**Flange Mount Cylinders**

The controlled diameter rod bushing extension can be used as a pilot to locate the flange mount. Dowel pins should be used after the cylinder is mounted and aligned to prevent shifting.

**Clevis Mount Cylinders**

This type of cylinder must be pivoted at both ends and the pins must be in line and parallel to each other. After the cylinder is

mounted, the customer should check to assure that the cylinder is free to swing through its working arc without interference from other machined parts.

**STORAGE**

Often times, cylinders are delivered before a customer is prepared to install them and must be stored for a period of time. When storage is required:

1. Select an area indoors for storage, which has dry and non-corrosive atmosphere. Take caution to protect the cylinder from both internal and external corrosion.
2. Cylinders to be stored should be kept in a vertical position (piston rod up) whenever possible.
3. Port protector plugs should be kept in the cylinder ports until the time of installation.



## CYLINDER TROUBLE SHOOTING

### External leakage

If leaking occurs between the end cap and barrel, check tie-rod torque. Do not over torque. If the torque is correct, then replace the barrel seal. When leakage occurs in the rod bushing area, replace the rod seals. If leakage continues or reoccurs in short period of operation, check items 2 thru 5, page 99.

### Cylinder misalignment

Side load is a common problem which occurs when the cylinder application does not allow the piston rod to work in line during the extend and retract motions of the cylinder. Evidence of this is excessive seal failure, bushing wear or galling of the piston rod. Often, bending of the piston rod or complete failure (breakage) of the rod occurs.

### Contamination on the piston rod

Dirt and other material is often picked up when the piston rod is extended. When the rod is retracted in an excessive dirty application, it often carries the dirt back into the rod seal cavity of the cylinder, causing damage to the seals. With a slight modification of the cylinder rod end, a rod boot can be added to protect the rod bushing and seals for most applications.

### Bad mountings

Due to wear of pivot pins or mounting bolts working loose, a cylinder may have side load, even though the rod was in line when the cylinder was first installed. All cylinder mountings should be checked periodically.

### Damaged piston rod

An extended piston rod can be damaged by the impact of a hard object which could burr the rod. If this occurs, the rod should be checked immediately to prevent seal damage.

### Internal leakage

Inside the cylinder, leakage past the piston seals can cause sluggish movement or settling of the cylinder under load conditions. This occurs due to leakage of worn piston seals or rings.

### Creeping cylinder

When a cylinder is stopped in midstroke and it creeps, check for internal leakage. Creeping can also be caused by a worn control valve and this should be checked, even if the cylinder is found to have internal leakage.

## CYLINDER MAINTENANCE

### Rod Seal Replacement

When changing rod seals, extend the piston rod 3" or more if possible, being sure to support the rod at all times. Remove the retainer plate screws (if tie-rod nuts have to be removed, refer to the nut torque specification on this page when reassembling the cylinder), retainer plate and outer bushing. Using an eye hook or thin screwdriver, pry the vees from the end cap cavity (if low pressure air is applied to the rod end port, this will help to force the vees from the cavity). The new set of vees should be assembled into the cavity separately and lubed with the soft vee in the center. Replace the rod wiper in the bushing and reassemble the cylinder.

### Piston Seal Replacement

When changing piston seals, extend the piston rod 3" or more if possible, being sure to support the piston rod and the piston at all times. \*Remove the tie-rod nuts, blind end cap, the barrel and then the piston seals. A light grease, compatible with the system fluid, should be used on the rings and u-cup seals for smooth assembly. Install the u-cup piston seals, scarf cutting on only the back-up washers. Then install the cast iron rings with the joints in opposite directions. To reassemble, start the piston into the tube, compressing the cast iron rings using twine or a ring compressor. When the piston u-cup seal is to the edge of the barrel, use a thin rounded blade to start the lip of the u-cup, making sure the entire lip is started before moving the piston further into the tube.

**\*Note:** When a cylinder has been disassembled this far, the barrel seals should at least be inspected, if not replaced.

### Barrel Seal Replacement

When replacing barrel seals, use the same method of disassembling the cylinder as used when replacing piston seals. The barrel seal is a gasket which is layed into the end cap tube groove first. Then position the end caps squarely on the tube (check to make sure port location is correct), and firmly force or tap the end cap over the tube until it bottoms. Check to make sure the gasket did not move and then finish assembling the cylinder.