



AMERICAN FORGE & FOUNDRY™



**Professional Products.
Professional Results.**



AMERICANFORGE&FOUNDRY™

PROFESSIONAL PRODUCTS. PROFESSIONAL RESULTS.

Since 1963 American Forge & Foundry has provided a “one stop shop” for professional grade hydraulic lifting, lubrication, and material handling products, as well as tools and equipment.







Serving Independent heavy duty repair shops, tire, fleet, agricultural, and other demanding industries; the AFF brand has become synonymous with quality, productivity, and safety. With scores of new products being added each year, we understand the latest trends in the industry and are committed to helping deliver creative solutions for the professional user.

American Forge & Foundry has received numerous accolades by following one simple rule: customers talk and we listen. Whether it's our industry-best fill rate, fastest order turnaround, or the availability of repair parts and repair depots; the AFF Team works hard to make it simple.

Visit us at www.affjaxx.com to see our full selection of existing and new products

To contact our sales or customer service team:
Email: sales@affjaxx.com
Phone: 518-861-0101
Fax: 518-861-0099

American Forge and Foundry has made every effort to provide accurate and up-to-date features, specifications and photos of our products for your information. American Forge and Foundry reserves the right to make changes in design, appearance and construction of any and all products listed herein without incurring any obligation in making such changes in products previously sold or transferred. We reserve the right to discontinue the availability of any products at such time we deem necessary.

| Category | Product Example | Pages | Category | Product Example | Pages |
|--------------------|---|-------|-------------------|---|-------|
| Floor Jacks |  | 4-7 | Engine Stands |  | 24 |
| Long Chassis Jacks |  | 8-9 | Stands |  | 25-27 |
| Axle Jacks |  | 10-11 | Bottle Jacks |  | 28-29 |
| Multi-Stage Jacks |  | 12-13 | Shop Presses |  | 30-33 |
| Transmission Jacks |  | 14-17 | Portable Power |  | 34-37 |
| Clutch Jacks |  | 18-19 | Material Handling |  | 38-40 |
| Air Lifts |  | 20 | Shop Equipment |  | 41-46 |
| Wheel Dollies |  | 21 | Lubrication |  | 47-55 |
| Engine Cranes |  | 22-23 | Air Tools |  | 56-57 |

Visit our website at www.affjaxx.com to see this catalog and our new product offering



AFF FLOOR JACKS are **heavy duty** and designed to meet the demanding lifting needs of the professional service technician. Features include heavy gauge steel, flanged side plates for strength, UV powder coat paint, and a safety overload valve for added protection. These are some of the strongest and most durable floor jacks in the industry.

**3.5 TON PROFESSIONAL HEAVY-DUTY DOUBLE-PUMPER FLOOR JACK
MODEL 350SS**

This unit offers all the features of our Model 350GT with additional speed and efficiency thanks to AFF's double-pumper advantage for quicker lifting.

- Lifts from 4" to 19.5"
- Pinned steel saddle (1-1/8" stud) with rubber pad for added vehicle protection
- Rear mounted 2.75" swivel casters for ease of maneuverability
- One piece 50.25" padded handle parks upright
- Equipped with a double pump design to increase speed without compromising overall performance of the jack
- Second volume pump assists in getting the saddle to load much quicker than most other single pump designs on the market today
- Tough powder coated frame for longer shop life

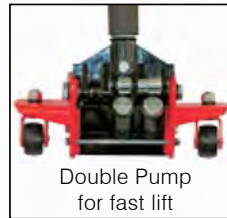

| MODEL | CAPACITY (tons) | LOW HEIGHT | HIGH HEIGHT | CHASSIS LENGTH | OVERALL WIDTH (front) | OVERALL WIDTH (rear) | SHIP WEIGHT |
|-------|-----------------|------------|-------------|----------------|-----------------------|----------------------|-------------|
| 350SS | 3-1/2 | 4" | 19.5" | 29" | 11.25" | 15" | 119 lbs. |

**3.5 TON PROFESSIONAL HEAVY-DUTY FLOOR JACK
MODEL 350GT**

The Heavy Duty standard for tire and service shops!

- Lifts from 4" to 19.5"
- Pinned steel saddle (1.125" stud) with rubber pad for added vehicle protection
- Rear-mounted 2.75" swivel casters for ease of maneuverability
- One-piece 50.25" padded handle parks upright
- Extra wide front casters for superior stability
- Safety valve prevents overload
- Flanged side plates for increased strength and stability
- Universal joint technology for precision control of release valve
- High strength steel yoke
- Tough powder coated frame for longer shop life



| MODEL | CAPACITY (tons) | LOW HEIGHT | HIGH HEIGHT | CHASSIS LENGTH | OVERALL WIDTH (front) | OVERALL WIDTH (rear) | SHIP WEIGHT |
|-------|-----------------|------------|-------------|----------------|-----------------------|----------------------|-------------|
| 350GT | 3.5 | 4" | 19.5" | 29" | 11.25" | 15" | 117 lbs. |

**3 TON HEAVY DUTY LOW PROFILE DOUBLE-PUMPER FLOOR JACK
MODEL 300T**

- Super low pick up point of 3.75"
- High height of 21.5" (2.0" higher than 350SS, 1.5" higher than 200T)
- Pinned steel saddle (1-1/8" stud) with rubber pad for added vehicle protection
- Universal joint technology for precise release valve control
- Safety valve to prevent overloading
- Plungers use a 'U' Cup design instead of O ring, for a better seal
- Centered pump plunger design offer 20% longer life over offset
- Release valve porting is designed for slower controlled descent
- Pump design engages sooner for longer stroke
- Tough powder-coated frame for longer shop life

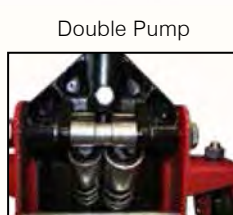

| MODEL | CAPACITY (tons) | LOW HEIGHT | HIGH HEIGHT | CHASSIS LENGTH | OVERALL WIDTH (front) | OVERALL WIDTH (rear) | SHIP WEIGHT |
|-------|-----------------|------------|-------------|----------------|-----------------------|----------------------|-------------|
| 300T | 3 | 3.75" | 21.5" | 30.75" | 11.375" | 14.5" | 104 lbs. |

2-TON LOW-PROFILE FLOOR JACK

MODEL 200T

- Super low pickup height of 2-3/4"
- Pinned steel saddle (1" stud) with rubber pad for added vehicle protection and durability
- One-piece foam covered 50" handle for ease of positioning, pumping and storage.
- Equipped with a double pump design to increase speed without compromising performance.
- Universal joint technology and precision release valve for a more controlled release
- Safety valve prevents overload
- Tough UV powder coated frame for greater protection and durability

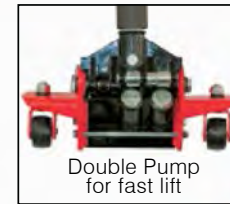

| MODEL | CAPACITY (tons) | LOW HEIGHT | HIGH HEIGHT | CHASSIS LENGTH | OVERALL WIDTH (front) | OVERALL WIDTH (rear) | SHIP WEIGHT |
|-------|-----------------|------------|-------------|----------------|-----------------------|----------------------|-------------|
| 200T | 2 | 2.75" | 20" | 27" | 11.75" | 15" | 99 lbs. |

1.5 TON, ALUMINUM RACING JACK

MODEL 206

- Double pump design for faster lifts
- Padded 2-pc handle
- Padded saddle to help protect vehicle during lift
- Front rollers and a single side handle
- Lightweight, rugged and super fast



| MODEL | CAPACITY (tons) | LOW HEIGHT | HIGH HEIGHT | CHASSIS LENGTH | OVERALL WIDTH (front) | OVERALL WIDTH (rear) | SHIP WEIGHT |
|-------|-----------------|------------|-------------|----------------|-----------------------|----------------------|-------------|
| 206 | 1.5 | 3.25" | 15" | 20" | 6" | 10" | 30 lbs. |

2 TON, ALUMINUM RACING JACK

MODEL 208

- Double pump design for faster lifts
- Padded 2-pc handle
- Padded saddle to help protect vehicle during lift
- Front wheels and two side handles
- Lightweight, rugged and super fast



| MODEL | CAPACITY (tons) | LOW HEIGHT | HIGH HEIGHT | CHASSIS LENGTH | OVERALL WIDTH (front) | OVERALL WIDTH (rear) | SHIP WEIGHT |
|-------|-----------------|------------|-------------|----------------|-----------------------|----------------------|-------------|
| 208 | 2 | 3.5" | 18.5" | 24.5" | 10.75" | 11.5" | 47 lbs. |

3 TON, ALUMINUM RACING JACK

MODEL 210

- Double pump design for faster lifts
- Padded 2-pc handle
- Padded saddle to help protect vehicle during lift
- Front wheels and two side handles
- Lightweight, rugged and super fast



| MODEL | CAPACITY (tons) | LOW HEIGHT | HIGH HEIGHT | CHASSIS LENGTH | OVERALL WIDTH (front) | OVERALL WIDTH (rear) | SHIP WEIGHT |
|-------|-----------------|------------|-------------|----------------|-----------------------|----------------------|-------------|
| 210 | 3 | 3.75" | 19.5" | 26" | 11.5" | 13.5" | 58 lbs. |



AFF Specialty Floor Jacks and Accessories are designed for applications where added reach and/or height are required. Each unit is designed with our heavy gauge steel frames and is powder coated for added protection.

7-TON FORKLIFT JACK
MODEL 3917

The scissor jack point is low enough to efficiently access and lift a variety of popular forklift models.

- Scissors lift from 2.5" to 16.5"
- 14" reach in raised position
- Safety valve provides critical overload protection
- Rugged wheels make load alignment easier
- Chassis 26" long x 9" wide

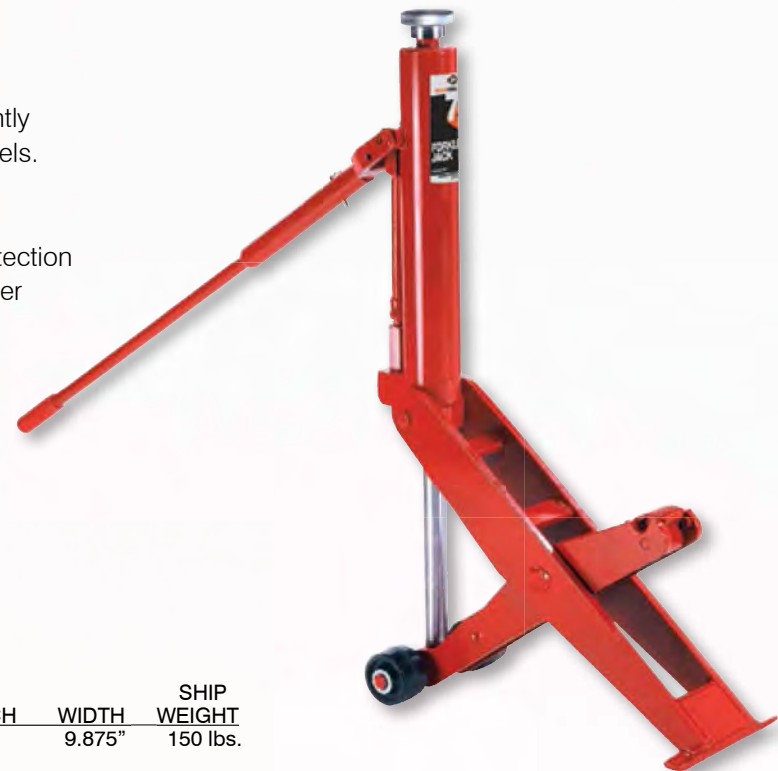

| MODEL | CAPACITY (tons) | LOW HEIGHT | HIGH HEIGHT | REACH | WIDTH | SHIP WEIGHT |
|-------|-----------------|------------|-------------|-------|--------|-------------|
| 3917 | 7 | 2.5" | 16.5" | 14" | 9.875" | 150 lbs. |

Floor Jack Accessories

750 LB. CAPACITY TRANSMISSION ADAPTER HEAD
MODEL 3165

Converts any AFF 350 series or Viking floor jack (or others with a 1-1/8" saddle stud) to remove and install automobile transmissions, transfer cases and differentials.

- Saddle is 19.5" wide
- 30° front tilt and 15° back tilt.
- Ship weight 28 lbs.



CROSSBEAM ADAPTER
MODEL 3167

Use any AFF or Viking floor jacks with a 1/1-8" diameter saddle stud to lift the entire front or rear of a vehicle.

- 4,400 lb. capacity
- Two telescopic 4.75" x 4.75" rubber saddle pads for added vehicle protection easily adjust to a maximum 38" width
- Ship weight 31 lbs.



Adapters work on all AFF jacks except 300T

Floor Jack Replacement Parts

REPLACEMENT SADDLE PAD
MODEL 200TK42
Fits AFF Model 200T floor jack.
Ship weight 1 lb.



REPLACEMENT SADDLE PAD
MODEL 350GTK41
Fits AFF Model 350GT & 350SS floor jacks.
Ship weight 1 lb.



POLYURETHANE WHEEL KIT
MODEL 35014P

Designed to allow use of AFF Model 350GT and 350SS floor jacks on tile, epoxy or sealed floors. Kit includes two front wheels and two rear casters that are easily installed to protect special floor surfaces.
Ship weight 7 lbs.



AFF JACK HANDLE BUMPER
MODEL 390

- Protects vehicle from dings and scrapes if jack handle accidentally falls against car.
- Fits 200T, 3003, 350 Series & most 2" handles.
- "Tight-fit" design keeps handle pad firmly in place.
- Made of solvent resistant high impact plastic.
- Air filled end cap provides additional impact protection.
- Inexpensive insurance for car finishes.
- Works on many other shop tools such as tire tools, bead breakers, press handles, etc.
- Ship weight 1lb.



REPLACEMENT FOAM HANDLE COVER
MODEL 350GTK23
Fits all AFF Model 350 series floor jacks
Ship weight 7 lbs.

REPLACEMENT FOAM HANDLE COVER
MODEL 200TK40
Fits AFF Model 200T floor jack
Ship weight 7 lbs.



ONE PIECE HANDLE
MODEL 350SSK24
Fits AFF Model 200T, 350GT & 350SS floor jacks
Ship weight 8 lbs.

Call AFF for complete list of parts



AFF Long-Chassis Floor Jacks are designed for heavy duty lifting applications such as bus and truck fleets, agriculture, industrial, and heavy construction equipment, where a heavy lift and long reach is needed. All AFF air-assisted floor jacks can be operated manually when shop air is not available.

Air/Hydraulic

10-TON CAPACITY HEAVY-DUTY AIR/HYDRAULIC LONG-CHASSIS JACK MODEL 3135

Designed for heavy-duty lifting applications (such as bus and truck fleets, agricultural, industrial and heavy construction equipment) requiring access to very low hard-to-reach areas.

- Operates at 115-200 PSI, 7.8 cubic feet per minute
- Long 61" body with 8.25" frame height for easier lifting of vehicles with long overhangs
- Foot-operated pump for quick lifting efficiency
- Automatic overload safety valves
- Large, rugged 4.5" front wheels and 2.75" rear casters
- Handle-mounted control lever to lock handle in 1 of 3 positions
- Can be operated manually when shop air is not available

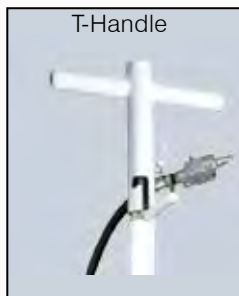

| MODEL | CAPACITY (tons) | LOW HEIGHT | HIGH HEIGHT | LENGTH | FRONT WIDTH | REAR WIDTH | SHIP WEIGHT |
|-------|-----------------|------------|-------------|--------|-------------|------------|-------------|
| 3135 | 10 | 7" | 23" | 61" | 13" | 18" | 387 lbs. |

5-TON CAPACITY HEAVY-DUTY AIR/HYDRAULIC LONG-CHASSIS JACK MODEL 3125

Designed for heavy-duty lifting applications (such as bus and truck fleets, agricultural, industrial and heavy construction equipment) requiring access to very low hard-to-reach areas.

- Operates at 115-200 PSI, 7.8 cubic feet per minute
- Long 56" body
- Foot-operated pump for quick lifting efficiency
- Automatic overload safety valves
- Large, rugged 4.5" front wheels and 2.75" rear casters
- Handle-mounted control lever to lock handle in 1 of 3 positions
- Can be operated manually when shop air is not available

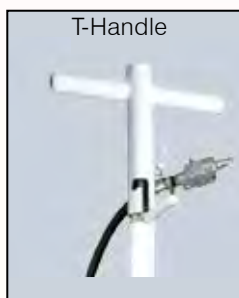

| MODEL | CAPACITY (tons) | LOW HEIGHT | HIGH HEIGHT | LENGTH | FRONT WIDTH | REAR WIDTH | SHIP WEIGHT |
|-------|-----------------|------------|-------------|--------|-------------|------------|-------------|
| 3125 | 5 | 6" | 22.5" | 56" | 11.5" | 15" | 273 lbs. |

Manual Hydraulic

20-TON CAPACITY HEAVY DUTY HYDRAULIC LONG-CHASSIS SERVICE JACK MODEL 3140

Designed for heavy-duty lifting applications (such as bus and truck fleets, agricultural, industrial and heavy construction equipment) requiring access to very low hard-to-reach areas.

- Long 67" body for easier lifting of vehicles with long overhangs
- Dual steel front wheels for added security & durability
- Automatic overload safety valves
- Handle-mounted control lever to lock handle in 1 of 3 positions

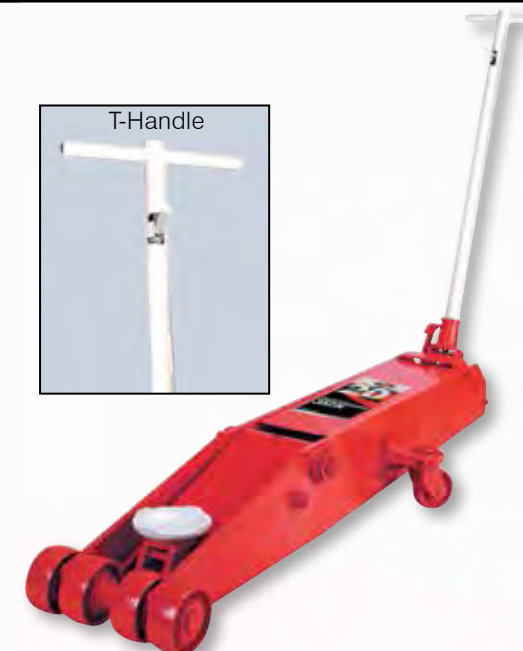

| MODEL | CAPACITY (tons) | LOW HEIGHT | HIGH HEIGHT | LENGTH | FRONT WIDTH | REAR WIDTH | SHIP WEIGHT |
|-------|-----------------|------------|-------------|--------|-------------|------------|-------------|
| 3140 | 20 | 7.75" | 23.75" | 67" | 14.5" | 19.75" | 450 lbs. |

10-TON CAPACITY HEAVY-DUTY HYDRAULIC LONG-CHASSIS JACK MODEL 3130

Designed for heavy-duty lifting applications (such as bus and truck fleets, agricultural, industrial and heavy construction equipment) requiring access to very low hard-to-reach areas.

- Long 61" body for easier lifting of vehicle with long overhangs
- Foot-operated pump for greater lifting efficiency
- Automatic overload safety valves
- Swivel casters for ease of maneuverability in tight shop situations
- Handle-mounted control lever to lock handle in 1 of 3 positions
- Extra-wide stance for additional stability



| MODEL | CAPACITY (tons) | LOW HEIGHT | HIGH HEIGHT | LENGTH | FRONT WIDTH | REAR WIDTH | SHIP WEIGHT |
|-------|-----------------|------------|-------------|--------|-------------|------------|-------------|
| 3130 | 10 | 7" | 23" | 61" | 13" | 18" | 366 lbs. |

5-TON CAPACITY HEAVY-DUTY HYDRAULIC LONG-CHASSIS JACK MODEL 3120

Designed for heavy-duty lifting applications (such as bus and truck fleets, agricultural, industrial and heavy construction equipment) requiring access to very low hard-to-reach areas.

- Long 56" body for easier lifting of vehicle with long overhangs
- Foot-operated pump for quick lifting efficiency
- Automatic overload safety valves
- Swivel casters for ease of maneuverability in tight shop situations
- A handle-mounted control lever to lock handle in 1 of 3 positions

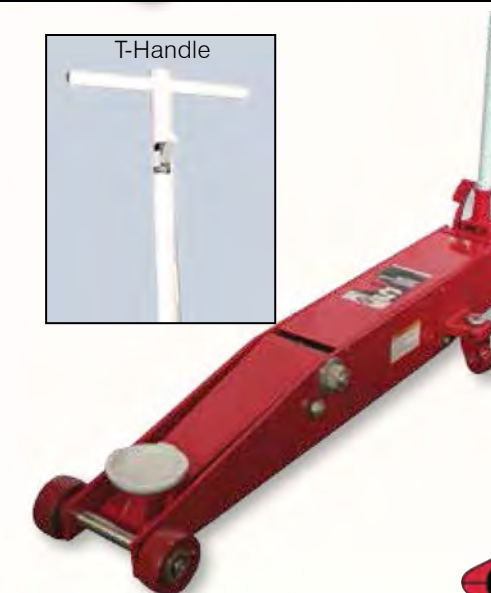

| MODEL | CAPACITY (tons) | LOW HEIGHT | HIGH HEIGHT | LENGTH | FRONT WIDTH | REAR WIDTH | SHIP WEIGHT |
|-------|-----------------|------------|-------------|--------|-------------|------------|-------------|
| 3120 | 5 | 6" | 22.5" | 56" | 11.5" | 15" | 254 lbs. |



AFF Air/Hydraulic Axle Jacks are designed and built to withstand the extreme conditions of every day use in heavy duty applications, including roadside service, fleet maintenance, off-road vehicle service and much more.

**50-TON AIR/HYDRAULIC AXLE JACK
MODEL 551**

- Largest capacity air/hydraulic single stage axle jack in the AFF line
- Heat treated cylinder wall and chromed piston give added stability and longer jack life
- Alloy steel lifting mechanism for added durability and operator safety
- Precision engineered tolerances for maximum performance
- In-line filter to protect air motor from contaminants
- Automatic in-line oiler to lubricate air motor
- Ram extension kit included with 3/4", 2-3/8", and 4" extensions
- Large 8-5/8" wheels for easy positioning
- One piece handle



Available Early 2014

| MODEL | CAPACITY (tons) | RAM LIFT | LOW HEIGHT | HIGH HEIGHT | REACH | WIDTH | SHIP WEIGHT |
|-------|-----------------|----------|------------|-------------|-------|---------|-------------|
| 551 | 50 | 5-3/4" | 12-3/8" | 26-1/2" | 65" | 14-1/2" | 158 lbs. |

**44-TON AIR/HYDRAULIC AXLE JACK
MODEL 544**

- AFF's largest capacity air / hydraulic single stage truck jack
- Outstanding durability and quality
- 41" one piece "T" handle
- Large rubber tires for easy movement
- Heat treated cylinder wall protects against scoring
- Operates at 90 - 180 PSI
- Easily handles full load roadside truck changes, agricultural equipment, heavy construction, bus and military applications



**3-PC EXTENSION KIT (sold separately)
MODEL 544EXT**

- Includes 1-2/16", 2-3/4" & 4-5/16" ram extensions for AFF Model 544.
- Ship weight 12 lbs.

| MODEL | CAPACITY (tons) | RAM LIFT | LOW HEIGHT | HIGH HEIGHT | REACH | WIDTH | SHIP WEIGHT |
|-------|-----------------|----------|------------|-------------|-------|-------|-------------|
| 544 | 44 | 4" | 9-1/4" | 16-1/4" | 64" | 19" | 145 lbs. |



**35-TON AIR/HYDRAULIC AXLE JACK
MODEL 536**

- Heat treated cylinder wall and chromed piston give added stability and longer jack life
- Alloy steel lifting mechanism for added durability and operator safety
- Precision engineered tolerances for maximum performance
- In-line filter to protect air motor from contaminants
- Automatic in-line oiler to lubricate air motor
- Ram extension kit included with 3/4", 2-3/8", and 4" extensions
- Large 8-5/8" wheels for easy positioning
- Two piece handle



Available Early 2014

| MODEL | CAPACITY (tons) | RAM LIFT | LOW HEIGHT | HIGH HEIGHT | REACH | WIDTH | SHIP WEIGHT |
|-------|-----------------|----------|------------|-------------|-------|---------|-------------|
| 536 | 35 | 4-1/2" | 10-5/8" | 23" | 58" | 12-1/2" | 110 lbs. |

22-TON AIR/HYDRAULIC AXLE JACK

MODEL 565E (2 pc. handle) MODEL 565E1 (1 pc. handle)

- Heat treated cylinder wall & chromed piston give added stability & longer jack life
- Alloy steel lifting mechanism for added durability and operator safety
- Precision engineered tolerances for maximum performance
- In-line filter to protect air motor from contaminants
- Corrosion-resistant aluminum and nylon composite air motor
- Ram extension kit included with 3/4", 2-3/4" and 4" extensions
- Large 7.75" rear wheels for easy positioning
- Automatic in-line oiler to lubricate air motor
- Grommet retainers-no need for clevis pins



3 pc. adaptor kit included as standard accessory



**ONE-PIECE "T" HANDLE
MODEL 565E-HANDLE**

This kit is for those who want to replace the 2-piece handle on their 565E 22-ton axle jack
Ship weight 14 lbs.

| MODEL | CAPACITY (tons) | RAM LIFT | LOW HEIGHT | HIGH HEIGHT | REACH | WIDTH | SHIP WEIGHT |
|-------|-----------------|----------|------------|-------------|-------|-------|-------------|
| 565E | 22 | 4.75" | 8.75" | 21.5" | 61" | 13" | 107 lbs. |
| 565E1 | 22 | 4.75" | 8.75" | 21.5" | 61" | 13" | 107 lbs. |

35-TON AIR/HYDRAULIC AXLE JACK

MODEL 535A

Designed for heavy-duty use in lifting trucks, buses, trailers or other heavy-duty equipment. AFF's Model 535A is compact, easy to maneuver and highly efficient. Large polyurethane wheels for durability and easy positioning.

- Lifts up to 21.25" with screw extension
- 55" long for hard-to-reach lift points under vehicles with long overhangs
- Can be operated with air (90-180 PSI) or manually
- Large wheels allow for easy positioning of jack under load.
- Unique design allows for vertical storage of jack when not in use
- Built-in safety valve prevents jack from being used beyond its capacity

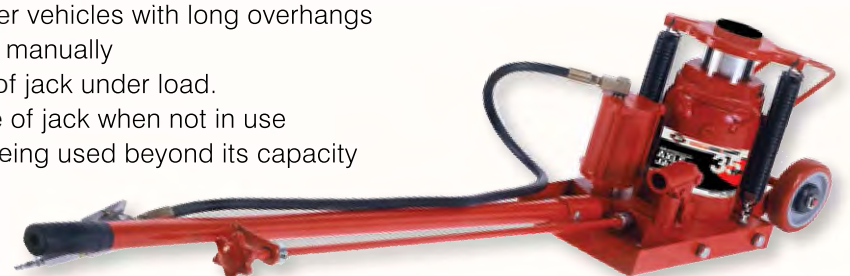

| MODEL | CAPACITY (tons) | RAM LIFT | LOW HEIGHT | HIGH HEIGHT | REACH | WIDTH | SHIP WEIGHT |
|-------|-----------------|----------|------------|-------------|-------|-------|-------------|
| 535A | 35 | 5.75" | 11" | 21.25" | 55" | 8" | 101 lbs. |



AFF Multi-Stage Jacks are **Super Heavy Duty** which means they are made to perform under the severe load conditions of trucking, agricultural and fleet businesses. An integral descent metering valve maintains a controlled lowering of the load, with air-assist to speed up ram retraction.

80/50 TON TWO STAGE AIR/HYDRAULIC AXLE JACK MODEL 549SD

- SUPER HEAVY DUTY 2 Stage 80 Ton and 50 Ton
- Extra long 138cm (54") handle can be locked in 3 positions to easily position jack in hard to reach places
- Integral Descent Metering Valve maintains a controlled and safe lowering of the load
- Single piece base construction provides superior strength for increased load stability
- Air assisted lowering speeds up ram retraction
- Comes with 2 extensions (75mm/3" + 46 mm/1.75") and saddle adapter



| MODEL | CAPACITY (tons) | RAM LIFT | LOW HEIGHT | HIGH HEIGHT | HIGH HEIGHT With Extensions | WORKING AIR PRESSURE | SHIP WEIGHT |
|-------|-----------------|----------|------------|-------------|-----------------------------|----------------------|-------------|
| 549SD | 80 | 3.03" | 9.06" | 13.39" | 19.14" | 116 to 174 PSI | 240 lbs. |
| | 50 | 5.79" | 9.06" | 17.32" | 23.07" | | |

60/40/20 TON THREE STAGE AIR/HYDRAULIC AXLE JACK MODEL 548SD

- SUPER HEAVY DUTY 3 Stage 60 Ton, 40 Ton and 20 Ton
- Extra long 138cm (54") handle can be locked in 3 positions to easily position jack in hard to reach places
- Single piece base construction provides superior strength for increased load stability
- Comes with 2 extensions (75mm/3" + 45 mm/1.75") and saddle adapter



| MODEL | CAPACITY (tons) | RAM LIFT | LOW HEIGHT | HIGH HEIGHT | HIGH HEIGHT With Extensions | WORKING AIR PRESSURE | SHIP WEIGHT |
|-------|-----------------|----------|------------|-------------|-----------------------------|----------------------|-------------|
| 548SD | 60 | 3.03" | 6.89" | 9.92" | 15.67" | 116 to 174 PSI | 165 lbs. |
| | 40 | 5.79" | 6.89" | 12.68" | 18.43" | | |
| | 20 | 9.02" | 6.89" | 15.91" | 21.66" | | |

50/25 TON TWO STAGE AIR/HYDRAULIC AXLE JACK MODEL 547SD

- SUPER HEAVY DUTY 2 Stage 50 Ton and 25 Ton
- Extra long 138cm (54") handle can be locked in 3 positions to easily position jack in hard to reach places
- Single piece base construction provides superior strength for increased load stability
- Air assisted lowering speeds up ram retraction
- Comes with 2 extensions (75mm/3" + 45 mm/1.75") and saddle adapter



| MODEL | CAPACITY (tons) | RAM LIFT | LOW HEIGHT | HIGH HEIGHT | HIGH HEIGHT With Extensions | WORKING AIR PRESSURE | SHIP WEIGHT |
|-------|-----------------|----------|------------|-------------|-----------------------------|----------------------|-------------|
| 547SD | 50 | 4.61" | 8.46" | 13.07" | 18.82" | 116 to 174 PSI | 165 lbs. |
| | 25 | 9.09" | 8.46" | 17.56" | 23.31" | | |

30/15 TON TWO STAGE AIR/HYDRAULIC AXLE JACK MODEL 545SD

- Extra light weight and portability makes this the ideal service jack for Service Vehicles
- 2 Stages and lifting capacities of 30 and 15 Ton make this a very versatile jack
- Extra long removable handle and rugged rear wheels to easily position the jack in hard to reach places.
- Air assisted lowering speeds up ram retraction
- Comes with 2 extensions (75mm/3" + 45 mm/1.75") and saddle adapter
- Units are tested to -13F(-25C) and +113F(+45C) as well as off center loading to ensure a long life under the harshest conditions
- Low height makes this one of the lowest operating heavy jacks on the market.
- Ideally suited for drop axles and other low clearance jobs.



| MODEL | CAPACITY (tons) | RAM LIFT | LOW HEIGHT | HIGH HEIGHT | HIGH HEIGHT With Extensions | WORKING AIR PRESSURE | SHIP WEIGHT |
|-------|-----------------|----------|------------|-------------|-----------------------------|----------------------|-------------|
| 545SD | 30 | 2.91" | 5.92" | 8.82" | 14.57" | 116 to 145 PSI | 77 lbs. |
| | 15 | 5.59" | 5.92" | 11.5" | 17.25" | | |

25/10 TON TWO STAGE AIR/HYDRAULIC AXLE JACK MODEL 546SD

- SUPER HEAVY DUTY, 2 Stage 25 Ton and 10 Ton
- Extra long 138cm (54") handle can be locked in 2 positions to easily position the jack in hard to reach places.
- Single piece base construction provides superior strength for increased load stability
- Air assisted lowering speeds up ram retraction
- Comes with 2 extensions (75mm/3" + 45 mm/1.75") and saddle adapter
- Units are tested to -13F(-25C) and +113F(+45C) as well as off center loading to ensure a long life under even the harshest conditions



| MODEL | CAPACITY (tons) | RAM LIFT | LOW HEIGHT | HIGH HEIGHT | HIGH HEIGHT With Extensions | WORKING AIR PRESSURE | SHIP WEIGHT |
|-------|-----------------|----------|------------|-------------|-----------------------------|----------------------|-------------|
| 546SD | 25 | 3.82" | 7.28" | 11.10" | 16.85" | 116 to 174 PSI | 128 lbs. |
| | 10 | 7.56" | 7.28" | 14.84" | 20.59" | | |



AFF Hydraulic Telescopic Transmission Jacks provide service technicians the capability for solo installations of transmissions, differentials or transfer cases. Capacities range between 700 lbs. and 2200 lbs. for applications from light-duty cars to mid-size trucks. See pages 16-17 for transmission jack adapters.

2-Stage Air-Assist Jacks

**1100 LB. CAPACITY AIR HYDRAULIC TELESCOPIC TRANSMISSION JACK
MODEL 3190SS**

The AFF 1/2 Ton capacity Air/Hydraulic Transmission Jack combines an air-operated first stage for maximum speed with a hydraulic second stage for more accurate final positioning.

- Four fast-ratcheting head brackets to easily secure to transmission pan flanges.
- Extendable height from 34" to 72-3/4"
- Large crank handles for precise head adjustments
- Strong nylon safety strap for secure load anchoring
- Solid (41" x 41") stance with heavy-duty, wide 4" swivel casters for easier, more efficient under-hoist positioning
- Unique "rapid rise" lift feature: first stage is air powered to get the jack to working height quickly, and the second stage allows for precise positioning



| MODEL | CAPACITY (lbs) | RAM STAGES | LOW HEIGHT | HIGH HEIGHT | FRONT TILT | REAR TILT | SIDE TILT | HEAD WIDTH | HEAD LENGTH | BASE WIDTH | SHIP WEIGHT |
|--------|----------------|------------|------------|-------------|------------|-----------|-----------|----------------|----------------|------------|-------------|
| 3190SS | 1100 | 2 | 34" | 72-3/4" | 50° | 20° | 10° | 8-1/2"-19-1/2" | 8-1/2"-19-1/2" | 41"x41" | 220 lbs. |

**1100 LB. CAPACITY AIR/HYDRAULIC TELESCOPIC TRANSMISSION JACK
MODEL 3192B**

Air or manual foot operated, two-stage ram frees both hands for easier alignment of automotive, van, and light truck transmissions, transfer cases or differentials in under hoist applications.

- Universal head provides forward, back and side tilt
- Fully-adjustable universal saddle with spring-loaded corner brackets for easy "tool-free" adjustment
- 90-120 PSI air pressure required; 7.875 cu. ft./min. air consumption
- May be used to remove and install fuel tanks when combined with AFF Fuel Tank Adapter #3198 (sold separately)



| MODEL | CAPACITY (lbs) | RAM STAGES | LOW HEIGHT | HIGH HEIGHT | FRONT TILT | REAR TILT | SIDE TILT | HEAD WIDTH | HEAD LENGTH | BASE WIDTH | SHIP WEIGHT |
|-------|----------------|------------|------------|-------------|------------|-----------|-----------|------------|-------------|------------|-------------|
| 3192A | 1100 | 2 | 38" | 73.5" | 42° | 46° | 2° | 7"-22" | 9"-20" | 38"x38" | 218 lbs. |

Single Stage Manual Jacks

**1100 LB. CAPACITY TELESCOPIC TRANSMISSION JACK
MODEL 2158**

Single-stage telescopic ram for use on automobile, light truck and van transmissions, transfer cases or differentials in under-hoist applications.

- Universal head provides forward and back tilt
- Wide base for maximum stability
- Foot-operated pump frees both hands for easier saddle-to-transmission alignment
- Convenient release knob



| MODEL | CAPACITY (lbs) | RAM STAGES | LOW HEIGHT | HIGH HEIGHT | FRONT TILT | REAR TILT | SIDE TILT | HEAD WIDTH | HEAD LENGTH | BASE WIDTH | SHIP WEIGHT |
|-------|----------------|------------|------------|-------------|------------|-----------|-----------|------------|-------------|------------|-------------|
| 2158 | 1100 | 1 | 45" | 71" | 30° | 15° | NA | 8"-14" | 14" | 23"x23" | 103 lbs. |

2-Stage Manual Jacks

**2200 LB. CAPACITY TELESCOPIC TRANSMISSION JACK
MODEL 2195B**

Two-stage telescopic ram, designed for heavier automotive and medium-duty truck transmissions, transfer cases or differentials in under-hoist applications.

- Universal head provides forward, back and side tilt
- Automatic safety valve provides critical overload protection
- Adjustable saddle with corner brackets and safety chain
- May be used to remove and install fuel tanks when combined with AFF Fuel Tank Adapter #3198 (sold separately)



| MODEL | CAPACITY (lbs) | RAM STAGES | LOW HEIGHT | HIGH HEIGHT | FRONT TILT | REAR TILT | SIDE TILT | HEAD WIDTH | HEAD LENGTH | BASE WIDTH | SHIP WEIGHT |
|-------|----------------|------------|------------|-------------|------------|-----------|-----------|------------|-------------|------------|-------------|
| 2195B | 2200 | 2 | 38" | 73.5" | 30° | 15° | 12° | 10"-14" | 14"-18" | 44"x44" | 237 lbs. |

**1100 LB. CAPACITY TELESCOPIC TRANSMISSION JACK
MODEL 3190B**

Two stage manual hydraulic operation.

- Universal head provides forward, back and side tilt
- Fully adjustable universal saddle with spring-loaded corner brackets for easy "tool-free" adjustment
- May be used to remove and install fuel tanks when combined with AFF Fuel Tank Adapter #3198 (sold separately)



| MODEL | CAPACITY (lbs) | RAM STAGES | LOW HEIGHT | HIGH HEIGHT | FRONT TILT | REAR TILT | SIDE TILT | HEAD WIDTH | HEAD LENGTH | BASE WIDTH | SHIP WEIGHT |
|-------|----------------|------------|------------|-------------|------------|-----------|-----------|------------|-------------|------------|-------------|
| 3190B | 1100 | 2 | 38" | 73.5" | 42° | 46° | 12° | 7"-22" | 9"-20" | 38"x38" | 203 lbs. |

Single Stage Manual Jacks

**700 LB. CAPACITY TELESCOPIC TRANSMISSION JACK
MODEL 2145**

Economical single stage ram for use on automobile transmissions, transfer cases or differentials in under-hoist applications.

- Large 360° swivel casters
- Adjustable saddle
- Replaceable single-stage telescopic ram.
- 700 lbs. capacity
- Single stage ram



| MODEL | CAPACITY (lbs) | RAM STAGES | LOW HEIGHT | HIGH HEIGHT | FRONT TILT | REAR TILT | SIDE TILT | HEAD WIDTH | HEAD LENGTH | BASE WIDTH | SHIP WEIGHT |
|-------|----------------|------------|------------|-------------|------------|-----------|-----------|------------|-------------|------------|-------------|
| 2145 | 700 | 1 | 53" | 73" | 12° | 12° | NA | 10"-14" | 10"-14" | 39"x39" | 95 lbs. |



4400 LB. CAPACITY HEAVY-DUTY TRANSMISSION JACK**MODEL 3180**

AFF has the only super heavy-duty transmission jack with a 4,400 lb. capacity. Built "forge" tough to handle removal, transport and installation of transmissions, transfer cases or differentials on heavy-duty trucks, buses, agricultural and construction equipment.

- Fully adjustable saddle with maximum tilt for easier alignment
- Adjustable corner brackets
- Convenient side trays for small tools and parts
- Safety overload bypass system to prevent hydraulic damage
- 32" handle pivots 360° around pump
- Rugged industrial-grade 4" casters



| MODEL | CAPACITY (lbs) | LOW HEIGHT | HIGH HEIGHT | FRONT TILT | REAR TILT | SIDE TILT | HEAD WIDTH | HEAD LENGTH | WIDTH | LENGTH | SHIP WEIGHT |
|-------|----------------|------------|-------------|------------|-----------|-----------|------------|-------------|-------|--------|-------------|
| 3180 | 4400 | 8.5" | 34" | 15° | 30° | 12° | 12"-18" | 16"-20" | 26" | 43" | 374 lbs |

2000 LB. CAPACITY HEAVY-DUTY TRANSMISSION JACK**MODEL 3178**

- Designed for heavy truck service
- Adjustable width head plate and wedge-shaped brackets allows for a wide range of mounting options
- The 4-way tilting head makes for easier removal and installation of the transmission
- Equipped with a 360° swiveling handle for use in tight spots
- Head dimensions: Width - Min. 6.5", Max 18.25", Length - Min. 6.75", Max 18.5"
- Open leg design makes it very versatile
- Rugged heavy duty casters
- Safety chain included



| MODEL | CAPACITY (lbs) | LOW HEIGHT | HIGH HEIGHT | FRONT TILT | REAR TILT | SIDE TILT | HEAD WIDTH | HEAD LENGTH | WIDTH | LENGTH | SHIP WEIGHT |
|-------|----------------|------------|-------------|------------|-----------|-----------|------------|-------------|-------|--------|-------------|
| 3178 | 2000 | 6.5" | 31.5" | 79° | 9° | 10-18° | 18.25" | 18.25" | 18.5" | 37.5" | 335 lbs |

FUEL TANK ADAPTER**MODEL 3198**

Converts AFF Model 3190B, 3192A and 2195A transmission jacks to remove and install fuel tanks.

- 4" x 5.75" diameter saddles adjust from 19.75" to 31.75".
- Includes two safety straps and two grounding cables.
- 80 lb. capacity.
- Ship weight 59 lbs.

**450 LB. CAPACITY TRANSMISSION JACK****MODEL 3160**

- Adjustable head for easier positioning and alignment
- Nylon safety strap to secure load
- Requires 1/2" drive ratchet (not included)
- 450 lb. capacity
- Height: 7.25" - 22.5"
- Ship weight 43 lbs.

**LOW-PROFILE 2000 LB. CAPACITY TRANSMISSION JACK****MODEL 3172**

- Designed for light truck transmissions
- Fully adjustable universal saddle with corner brackets and safety chains
- Safety overload bypass to prevent hydraulic damage
- 24" handle pivots 360° around pump
- Four industrial-grade 3" casters



| MODEL | CAPACITY (lbs) | LOW HEIGHT | HIGH HEIGHT | FRONT TILT | REAR TILT | SIDE TILT | HEAD WIDTH | HEAD LENGTH | WIDTH | LENGTH | SHIP WEIGHT |
|-------|----------------|------------|-------------|------------|-----------|-----------|------------|-------------|--------|--------|-------------|
| 3172 | 2000 | 5.875" | 30.75" | 15° | 10° | 15° | 7"-16" | 9"-14" | 18.25" | 36.75" | 145 lbs |

LOW-PROFILE 1200 LB. CAPACITY TRANSMISSION JACK**MODEL 3171**

- Designed for light truck transmissions
- Fully adjustable universal saddle with corner brackets and safety chains
- Safety overload bypass to prevent hydraulic damage
- 24" handle pivots 360° around pump



| MODEL | CAPACITY (lbs) | LOW HEIGHT | HIGH HEIGHT | FRONT TILT | REAR TILT | SIDE TILT | HEAD WIDTH | HEAD LENGTH | WIDTH | LENGTH | SHIP WEIGHT |
|-------|----------------|------------|-------------|------------|-----------|-----------|------------|-------------|--------|--------|-------------|
| 3171 | 1200 | 6.875" | 31.75" | 15° | 12° | 15° | 7"-13" | 8"-11" | 19.75" | 38.25" | 117 lbs |

TRANSMISSION JACK ADAPTER SET**MODEL 3181**

- Ideal for use with AFF's model 3180 Heavy Duty Transmission Jack
- Works with a wide variety of different truck transmissions including Eaton® and Fuller®
- Comes with 6 adapter bars (4 small, 2 large) 4 positioning screws, and 2 securing chains



AFF Clutch Jack and Accessories are designed to assist in all aspects of clutch removal and transport. Accessories include various adapters are available to make the Clutch Jack a "one-man" operation.

CLUTCH JACK

MODEL 3700

- Highly efficient design that provides the technician with capability for solo removal, installation, and transportation of heavy-duty truck clutches
- Heavy-duty unit has a greater capacity than most competitors' units and has the added versatility of being able to convert with optional adapters for fly wheels, drive shafts, starter motors, auxiliary cases, differentials, brake drums and camel back springs (sold separately)
- Clutch head assembly turns 360° and pivots side-to-side for efficient clutch/engine alignment
- Two splined alignment shafts (2" OD x 1.18" pilot and 1.75" OD x .938" pilot)
- Clutch assemblies can be built on the vertical shaft and then positioned easily under the truck
- Pump handle rotates 360° for ease of operation in virtually any work position
- Unique clevis pinned alignment shaft allows technician to remove jack to install clutch assembly without obstruction
- Alignment shafts have "flats" for open end wrench to aid in clutch indexing and internally threaded for slide hammer removal if needed



Clutch quickly flips from vertical position to horizontal position for easy assembly



All CLUTCH JACK ACCESSORIES shown on the next page (page 19)

| MODEL | CAPACITY (lbs) | LOW HEIGHT | HIGH HEIGHT | FRAME DIMENSION | SHIP WEIGHT |
|-------|----------------|------------|-------------|-----------------|-------------|
| 3700 | 500 lbs. | 13" | 39" | 36.5" L x 22"W | 138 lbs |

FLYWHEEL ADAPTER

MODEL 3751

Easily replaces the spline and bolts onto flat and pot-style truck flywheels used with 14" and 15.5" clutches for more efficient removal and installation.

- Ship weight 6 lbs.



SPLINED SHAFT

MODEL 3749

- 1.75" OD x 1.18" Pilot
- Ship weight 6 lbs.

MODEL 3752

- 1.75" OD x 0.983" Pilot
- Ship weight 6 lbs.

MODEL 3753

- 2" OD x 1.18" Pilot
- Ship weight 6 lbs.



DRIVESHAFT ADAPTER

MODEL 3754

Supports heavy truck driveshafts under the main carrier bearing or the complete shaft, allowing one shop technician to safely move or align them.

- Ship weight 18 lbs.



DIFFERENTIAL ADAPTER

MODEL 3757

Makes removing and installing heavy truck differentials easier and safer by eliminating the need for personal heavy lifting by a shop technician.

- Ship weight 30 lbs.



Pin alignment allows technician to install clutch assembly with jack removed from work area

Pump handle rotates 360°

Head design turns 360° and pivots side-to-side for positive clutch alignment

2nd spline shaft

Versatile open leg design

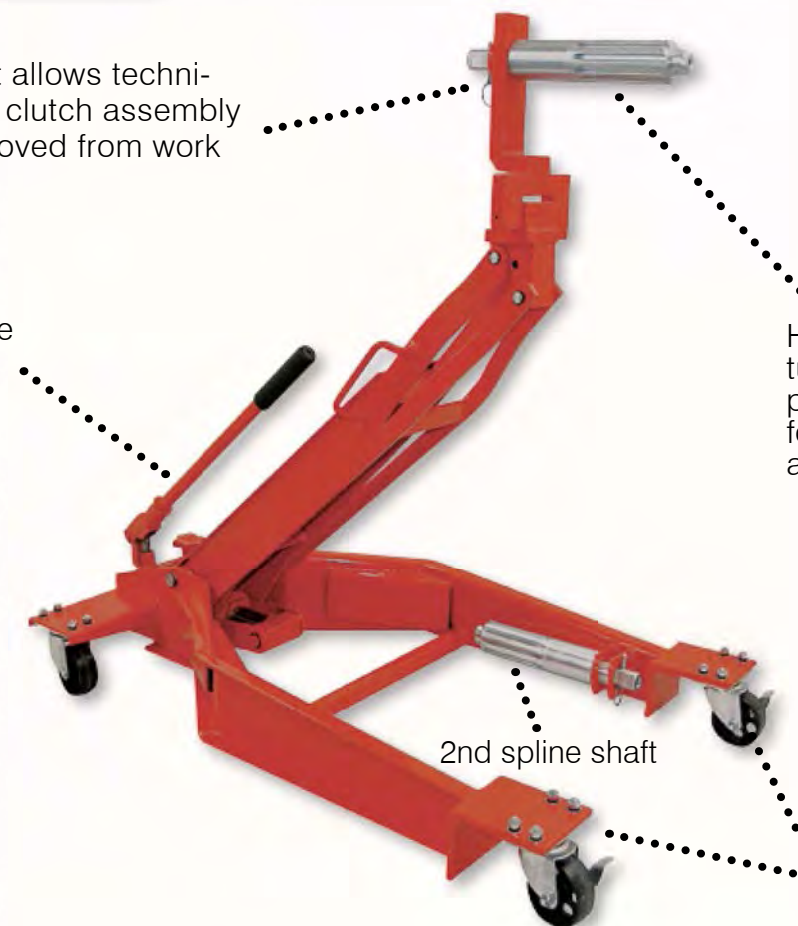

AFF Air Lift Jacks are designed to efficiently lift large trucks, tractors, trailers, buses, and heavy construction equipment. All units function 100% on air and include integrated locking mechanisms to hold the load (additional safety stands are still recommended).

10-TON AIR LIFT JACK

MODEL 3400A

This Air Lift Jack is designed for lifting and supporting trailers, large trucks, buses, farm, industrial, and construction equipment.

- 10-ton capacity achieved at 200-PSI air supply
- Heavy-duty air valve offers accurate lift control
- Removable "T" handle for easy storage
- Extension tubes offer multiple lifting and locking positions
- 12" Lift travel
- Large diameter rubber tread wheels



Support Pin

| MODEL | CAPACITY (tons) | LOW HEIGHT | HIGH HEIGHT | LENGTH | BASE WIDTH | OVERALL HEIGHT | SHIP WEIGHT |
|-------|-----------------|------------|-------------|--------|------------|----------------|-------------|
| 3400A | 10 | 18" | 52" | 27" | 12.75" | 18.25" | 172 lbs. |

5-1/2 TON LONG-REACH AIR END LIFT

MODEL 3596

Designed for heavy-duty, low-profile vehicles that require a longer reach in order to be securely lifted. Lifts the vehicle at the front axle, frame or bumper. The scissor-action design and full shop air operation (160 PSI) provide more lift height under low-profile vehicles. Using its multiple saddle sizes and adjustments along with its standard drop-axle adapter it can lift from as low as 6.5" to a high 53.5" with a long 48" forward reach.

- Steel saddles adjust between 23" & 45" widths to accommodate a variety of vehicle applications
- 48" forward reach (distance from cylinder to saddles)
- Two saddle sizes and drop axle adapter increase versatility
- Three-way heavy-duty air valve for precision lifting
- Automatic safety lock engages in five preset positions
- Two large pneumatic wheels for easy maneuverability



Adapters Included

| MODEL | CAPACITY (tons) | LOW HEIGHT | HIGH HEIGHT | LENGTH | BASE WIDTH | OVERALL HEIGHT | SHIP WEIGHT |
|-------|-----------------|------------|-------------|--------|------------|----------------|-------------|
| 3596 | 5.5 | 6.5" | 53.5" | 77" | 23" | 70" | 638 lbs. |

10-TON AIR END LIFT

MODEL 3598

The AFF Air End Lift is designed with an extra-wide stance to lift the entire front or rear of large trucks, buses, industrial, heavy-duty construction equipment, and large farm vehicles.

- 10-Ton capacity achieved at 200-PSI air supply
- 4" x 6" steel saddles adjust between 36" and 50" widths
- Saddle arms reversible for low height loads
- Three-way air valve for fine lifting and lowering control
- Automatic mechanical safety lock engages at five lift heights from 17.5" to 50"
- Two air control valve fittings – one for shop air supply and one for a Schrader valve
- Front swivel caster and two pneumatic rear tires for easy maneuverability
- 13" Forward reach (distance from cylinder to saddles)



| MODEL | CAPACITY (tons) | LOW HEIGHT | HIGH HEIGHT | LENGTH | BASE WIDTH | OVERALL HEIGHT | SHIP WEIGHT |
|-------|-----------------|------------|-------------|--------|------------|----------------|-------------|
| 3598 | 10 | 12.5" | 50" | 39" | 36" | 67" | 750 lbs. |

3/4-TON CAPACITY HEAVY-DUTY WHEEL DOLLY

MODEL 3577

Used to facilitate the efficient removal, installation and transport of single or dual truck wheel assemblies.

- Lift arms adjust inward and outward to handle different wheel combinations
- Provides extra low access to easily position heavy wheel assemblies
- Leveling screw for precise alignment
- Full 7.75" ram lift
- Six-foot safety chain secures wheels in place during removal and transport
- 3 large swivel casters



| MODEL | LOW HEIGHT | HIGH HEIGHT | LENGTH | WIDTH | SHIP WEIGHT |
|-------|------------|-------------|--------|-------|-------------|
| 3577 | 2.5" | 10.25" | 31" | 43" | 166 |

BRAKE DRUM HANDLER

MODEL 3595A

- Efficiently install, remove and transport 15" to 16.5" brake drums
- Heavy-duty steel construction
- Height adjustable rotary handle
- Adjustable brackets secure inboard and outboard drums with disc wheel hubs
- Removable rotating handle
- Ship weight 55 lbs.



PORTABLE TRUCK WHEEL DOLLY

MODEL 3590A

Designed for "one-technician operation", reducing repair labor costs. Ideal for road service applications.

- 300 lb. capacity
- Rugged tubular steel construction
- Handles wheels up to 24" diameter
- 8" rollers turn and pivot for accurate and efficient alignment of mounted truck tires with hub studs
- Ship weight 18 lbs.



SUPER SINGLE TRUCK WHEEL DOLLY

MODEL 3591

- Easily handles new super wide tires that are becoming prevalent in the trucking industry
- Provides technician with the leverage needed to handle the removal and installation of large tires
- Heavy duty tubular steel construction
- Bent handle design improves leverage and reduces user strain
- 14" rollers turn and pivot for accurate & efficient alignment of mounted truck tires with hub studs
- 26" wide carriage handles tire diameters 36" - 48"
- 450 lb. capacity
- Ship weight 25 lbs.

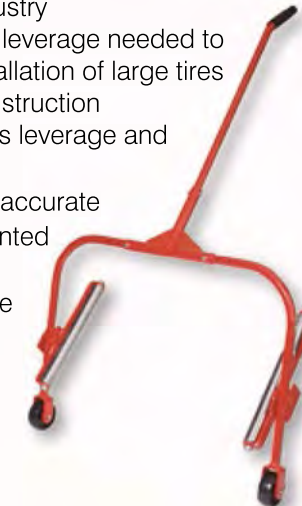

HEAVY-DUTY TRUCK WHEEL STEP

MODEL 3912A

- Truck step wraps over tire, providing a nonslip step for loading roof racks and servicing trucks, SUV's and semis.
- Fits truck tires up to 24.5" diameter.
- 9" x 27" step with rugged non-slip tread.
- Heavy duty quality
- Folds flat for storage
- Capacity: 300 lbs.
- 26.5" L x 9.5" W
- Nonskid Surface
- Ship weight 17.5 lbs



AUTOMOTIVE/LIGHT TRUCK WHEEL STEP

MODEL 3911A

- Adjustable Automotive / Light Truck step wraps over tire, providing a nonslip step for loading roof racks and servicing trucks, and SUV's.
- Heavy-duty quality
- Adjusts to tire depth and height
- Folds flat for storage
- Capacity: 300 lbs.
- 21" L x 7" W
- Nonskid Surface
- Ship weight: 14 lbs



AFF's Engine Cranes are designed for the easy and efficient removal and transport of vehicle engines. All feature four-position telescopic booms, wide stable bases, forged steel hooks with safety latches and heavy-duty swivel casters.

6000 LB CAPACITY HEAVY-DUTY ENGINE CRANE

MODEL 3584

- Heavy-duty engine crane with reinforced leg assemblies for added strength and durability.
- 4 different boom settings: 3, 2, 1.5 and 1 Ton.
- 12 Ton hydraulic ram has built in safety overload to protect the unit from being used beyond its rated capacity
- Large 4.25" rear swivel casters and 6" fixed front wheels provide ease of mobility and positioning
- Rear of crane stands 61.5" tall and 33" wide
- Distance between front of legs, retracted = 23", extended = 28.5"
- Ship weight 355 lbs.



WORKING DIMENSIONS

| Ton Setting | Max Ht. | Max Reach |
|------------------|---------|-----------|
| 3 Ton 6,000 lbs | 87.0" | 35" |
| 2 Ton 4,000 lbs | 91.5" | 42" |
| 1.5 Ton 3,000 lb | 95.5" | 50" |
| 1 Ton 2,000 lbs | 99.5" | 61" |

4400 LB. CAPACITY FOLDABLE ENGINE CRANE

MODEL 3582

The 3582's legs fold up and away, and with the ram completely retracted, give this unit an extremely small storage footprint.

- Boom extends from 40" to 63"
- 69" base length
- Fits into a 57" H x 12" W x 27" D space when folded
- Ship weight 225 lbs.



| MODEL | CAPACITY (lbs.) | Boom (lbs) Capacity | | | | Maximum Horizontal Reach | | | | Maximum Hook Height | | | | Ship Weight |
|-------|-----------------|---------------------|------|------|------|--------------------------|-----|-----|-----|---------------------|-------|-----|-----|-------------|
| | | 1 | 2 | 3 | 4 | 1 | 2 | 3 | 4 | 1 | 2 | 3 | 4 | |
| 3582 | 4400 | 4400 | 3300 | 2200 | 1100 | 23" | 31" | 38" | 45" | 72.5" | 77.5" | 82" | 87" | 225 lbs. |

1,000 LB. TRUCK MOUNTED CRANE

MODEL 3586B

- Rugged steel construction
- Boom working range: 28" to 42.5"
- Locking swivel base - 360 degree swivel
- Heavy-duty chain with safety lock
- Hydraulic operation provides easy lifting to desired height
- Designed to be installed in truck beds or vans
- Includes mounting plate & chain with grab hook
- Lifting range 0-75"
- Ship weight 106 lbs.



Shown in DOWN position



2200 LB. CAPACITY ENGINE TILTER

MODEL 582

Can be used with all AFF cranes as well as competitive models to efficiently change an engine's center-of-gravity when installing or removing from a vehicle.

- 23.5" wide support bracket easily attaches to the engine for lifting security
- Ship weight 19 lbs.



1100 LB. CAPACITY ENGINE SUPPORT

MODEL 583

- Provides overhead engine support for removal of trans axle on FWD vehicles
- Ideal for four- and six-cylinder FWD vehicles
- Adjusts from 26.5" to 49.5" wide with 18.75" screw travel
- Ship weight 38 lbs.



700 LB. CAPACITY TRANSVERSE ENGINE SUPPORT WITH ADDED SUPPORT BAR

MODEL 584

- Three support points for added stability
- 700 lb. Capacity
- 2 - 14" adjustable hook screws
- 2.125" x 38" braided steel cables
- Width expands from 34.5" to 61"
- Ship weight 27 lbs.



AFF Engine Stands are used in the positioning and transport of automobile and light truck engines in a wide variety of vehicle service facilities. All AFF Engine Stands include a 360° rotating head, which efficiently puts the engine in the optimal work position, rugged full swivel casters and heavy-duty tubular steel construction. Superior welds in all locations provide maximum strength and durability.

**1250 LB. CAPACITY ENGINE STAND
MODEL 573B**

- Extra-wide 4-point "U" type base ensures maximum stability and performance
- Adjustable brackets allow maximum flexibility – fits most automobile and light truck engines
- 360° rotating head enables placement of engine in desired work position
- Full swivel casters
- Heavy-duty welded steel base
- Features convenient tray for holding tools and parts



| MODEL | CAPACITY (lbs) | LENGTH | FRONT WIDTH | REAR WIDTH | SHIP WEIGHT |
|-------|----------------|--------|-------------|------------|-------------|
| 573B | 1250 | 34" | 33" | 33" | 83 lbs. |

**1000 LB. CAPACITY ENGINE STAND
MODEL 571B**

- Wide 4 point "H" type base ensures good stability
- Adjustable brackets allow maximum flexibility – fits most small engines
- 360° rotating head enables engine to be placed in desired work position
- Full swivel casters
- Heavy duty welded steel base



| MODEL | CAPACITY (lbs) | LENGTH | FRONT WIDTH | REAR WIDTH | SHIP WEIGHT |
|-------|----------------|--------|-------------|------------|-------------|
| 571B | 1000 | 36" | 19.5" | 33.25" | 67 lbs. |

AFF Jack Stands provide a safe and secure way to support vehicles once lifted and during under car maintenance. Our ratchet and pin-type stands are built using heavy steel with large support saddles. They are intended for use in pairs in automotive and fleet service as well as agricultural and construction equipment service facilities. The maximum load capacity for a matched pair shall not exceed the capacity of the individual stand. All stands meet ANSI PALD standards.

**3-TON JACK STAND SET
MODEL 3303**

- Notched saddles for use with unitized body vehicles
- Safety ratchet prevents lowering when saddle is loaded
- Convenient handle for release and carrying
- Adjusts from 11.75" to 17"
- 7" x 7.5" base
- Ship weight 16 lbs. per pair



**6-TON JACK STAND SET
MODEL 3306**

- Notched saddles for use with unitized body vehicles
- Safety ratchet prevents lowering when saddle is loaded
- Convenient handle for release and carrying
- Adjusts from 16" to 23.75"
- 9" x 10.5" base
- Ship weight 30 lbs. per pair



**12-TON JACK STAND SET
MODEL 3312B**

- Notched saddles for use with unitized body vehicles
- Safety ratchet prevents lowering when saddle is loaded
- Convenient handle for release and carrying
- Adjusts from 19.5" to 28"
- 11.625" x 13" base
- Ship weight 67 lbs. per pair



**5-TON CAPACITY FORKLIFT JACK STAND SET
MODEL 3305A**

- Pin-type post adjusts to four height positions from 13" to 17"
- Large 2.75" x 4" support saddles
- Heavy-duty 9" x 10" base secures and stabilizes load
- Ship weight 29 lbs. per pair



**10-TON CAPACITY TRUCK JACK STAND
MODEL 3309A**

- Pin-type post adjusts to seven height positions from 18.5" to 30"
- Large 3.125" x 5.875" support saddle and wide 17" x 17" base
- Convenient carrying handle
- Sold individually
- Ship weight 37 lbs.



**10-TON CAPACITY TRUCK STAND
MODEL 3310A**

- Heavy duty, pin-type post adjusts to ten height positions from 28" to 47"
- Large 3.125" x 5.875" support saddle and stable 16" x 16" base
- Sold individually
- Ship weight 55 lbs.



**20-TON HEAVY-DUTY JACK STAND
MODEL 3314**

- Efficient pin-type post with four height adjustment positions
- Adjusts from 12" to 20"
- Large 3" x 5" saddle
- Stable 10" x 10" steel base
- Balanced carrying handle
- Sold individually
- Ship weight 50 lbs.



AFF Under-Hoist and Stabilizing Stands, built with all-steel construction, are designed to stabilize vehicle system components in under-hoist applications. Model 3318 can be used to stabilize loaded and unloaded trailers when not connected to trucks.



AUXILIARY UNDER-HOIST COMPONENT STAND
MODEL 3320A

- Adjusts from 54.5" to 80.5"
- Foot-operated lever for extra lift
- Bearing included for smooth operation
- 12" diameter base
- Not designed to support vehicle; designed to support vehicle components
- Ship weight 36 lbs.



2-TON CAPACITY UNDER-HOIST STABILIZING STAND
MODEL 3315A

- Adjusts from 55" to 85.5"
- Ideal for exhaust and suspension work
- Bearing included for smooth operation
- Easily disassembles for storage
- 24" x 24" x 24" base
- Not designed to support entire vehicle
- Ship weight 44 lbs.



2-TON CAPACITY UNDER-HOIST STABILIZING STAND
MODEL 3233A

- Adjusts from 66.5" to 73"
- Bearing included for smooth operation
- Adjusting screw for easier load positioning
- 21" x 21" x 21" base
- Not designed to support entire vehicle
- Ship weight 26 lbs.



50-TON CAPACITY TRAILER STABILIZING STAND
MODEL 3318

- 100,000 lb. static load capacity
- 45,000 lb. lifting capacity
- Adjusts from 39" to 51"
- Pivoting, reversible ratchet head levels trailers on uneven ground
- Wide 14" diameter base for added stability
- Removable pipe handle
- Ship weight 157 lbs.

Meets OSHA requirements for stabilizing loaded and unloaded trailer

AFF Super Heavy Duty Truck Stands are designed for truck and bus support. Spring loaded caster wheels allow for easy positioning and portability. Non skid rubber saddle pad for secure placement.

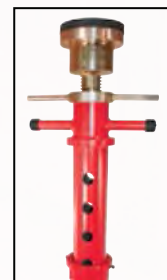

Adjustable Height

16.5 TON FIXED HIGH TRUCK STAND
MODEL 3340SD

- 16.5 ton capacity
- Adjustable height range from 57" to 82"
- 21-1" height adjustments with 4" fine adjustment by screw
- Spring-loaded casters for ease of positioning
- Spring-loaded tower for easy height adjustment
- Ship weight 324 lbs.



7.5 TON FIXED HIGH TRUCK STAND
MODEL 3342SD

- 7.5 ton capacity
- Adjustable height range from 57" to 82"
- 21-1" height adjustments with 4" fine adjustment by screw
- Rubber pad protects vehicle from damage
- Spring-loaded casters for ease of positioning
- Spring-loaded tower for easy height adjustment
- Ship weight 134 lbs.



7.5 TON FIXED HIGH TRUCK STAND
MODEL 3344SD

- 7.5 ton capacity
- Adjustable height range from 36" to 54"
- 17-1" height adjustments
- Rubber pad protects vehicle from damage
- Spring-loaded casters for ease of positioning
- Ship weight 103 lbs.



20 TON WIDE STANCE TRUCK RAMPS
MODEL 3420ASD

- Long retractable handle
- Wheels ease movement and stores easily out of the way
- Suitable for large truck tires up to 16" maximum width
- Comes with rubber non skid pad to prevent slippage
- 20 ton capacity per pair
- Frame = 47" L x 18.25" W x 9.25" H
- Overall length = 51"
- Tread Width = 16"
- Ships one pair in wooden crate
- Ship weight 396 lbs. per pair



Retractable Handle

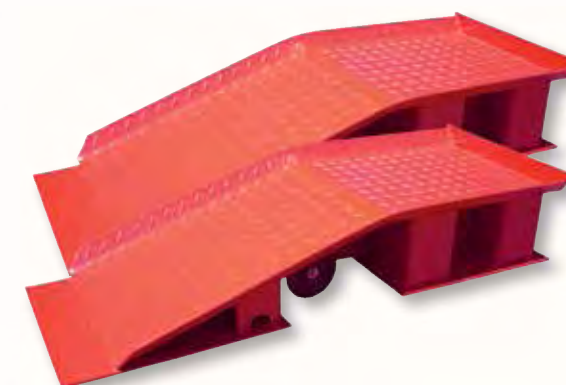

AFF Bottle Jacks are built "forge-tough" in a wide selection of capacities for automotive, marine, construction, industrial and agricultural applications where the ability to lift, push, spread, bend, press and straighten either horizontally or vertically are essential. All have centered pumps and rams with heat-treated pistons for balance and easy positioning. Their saddles are made of machine hardened steel. All models with capacities of 8 tons or higher have convenient carrying handles while model 3506C comes in a rugged plastic carrying case.

MODEL 3502



Capacity: 2 Tons
Low Ht: 6-1/4"
High Ht: 12-3/4"
Lift: 4"
Screw Ext: 2-1/2"
Base: 3-3/4"x 3-3/4"
Qty per Case: 6
Case Wt: 36 lbs.

MODEL 3504



Capacity: 4 Tons
Low Ht: 6-1/2"
High Ht: 13-1/4"
Lift: 4-1/4"
Screw Ext: 2-1/2"
Base: 4-1/2" x 4"
Qty per Case: 6
Case Wt: 52 lbs.

MODEL 3506



Capacity: 6 Tons
Low Ht: 8"
High Ht: 16"
Lift: 5-1/4"
Screw Ext: 2-3/4"
Base: 4-1/2"x 4-3/4"
Qty per Case: 4
Case Wt: 44 lbs.

MODEL 3506C



Capacity: 6 Tons
Low Ht: 8"
High Ht: 16"
Lift: 5-1/4"
Screw Ext: 2-3/4"
Base: 4-1/2"x 4-3/4"
Qty per Case: 4
Case Wt: 50 lbs.

Model 3506 with plastic carrying case

MODEL 3508



Capacity: 8 Tons
Low Ht: 7-3/4"
High Ht: 15-1/2"
Lift: 5"
Screw Ext: 2-3/4"
Base: 4-3/4" x 5"
Qty per Case: 4
Case Wt: 52 lbs.

MODEL 3512



Capacity: 12 Tons
Low Ht: 8-1/2"
High Ht: 17"
Lift: 5-3/4"
Screw Ext: 2-3/4"
Base: 5-1/2"x 5-1/4"
Qty per Case: 4
Case Wt: 68 lbs.

MODEL 3514



Capacity: 12 Tons
Low Ht: 7"
High Ht: 13"
Lift: 4"
Screw Ext: 2"
Base: 5-1/2"x 5-1/4"
Qty per Case: 4
Case Wt: 60 lbs.

MODEL 3520



Capacity: 20 Tons
Low Ht: 9-5/8"
High Ht: 18-1/4"
Lift: 6-3/8"
Screw Ext: 2-1/4"
Base: 6-3/4"x 6-1/4"
Qty per Case: 2
Case Wt: 54 lbs.

MODEL 3522



Capacity: 20 Tons
Low Ht: 7-3/4"
High Ht: 14-1/4"
Lift: 4-1/4"
Screw Ext: 2-1/4"
Base: 6-3/4"x 6-1/4"
Qty per Case: 2
Case Wt: 50 lbs.

MODEL 3530



Capacity: 30 Tons
Low Ht: 11"
High Ht: 18-5/8"
Lift: 7-5/8"
Screw Ext: --
Base: 7" x 7"
Qty per Case: 2
Case Wt: 88 lbs.

MODEL 3550



Capacity: 50 Tons
Low Ht: 12"
High Ht: 19"
Lift: 7"
Screw Ext: --
Base: 8-1/2" x 7"
Qty per Case: 1
Case Wt: 73 lbs.



AFF Bottle Jacks can be used in either vertical or horizontal positions

AFF Heavy-Duty Industrial Bottle Jacks set the highest market standards with their premium grade materials and workmanship. Precision welding, CNC machined parts, as well as forged high grade steel and alloys are combined to provide years of trouble-free service in some of the most severe conditions. All bottle jacks come with handles.

INDUSTRIAL BOTTLE JACKS

- Precision electrically welded steel uni-body
- Can be used in upright, horizontal or angled position
- Machine-hardened needle release valve for precisely controlled ram lowering
- Safety overload valves on 4535, 4560 and 4599
- Leak proof casing, cylinder, and base
- Used for lifting, pushing, spreading, bending, pressing or straightening applications
- Withstands temperature extremes
- Carrying handles
- Grooved saddles help prevent load slippage
- Chrome-plated piston rods for added corrosion resistance



AFF Bottle Jacks can be used in either vertical or horizontal positions

MODEL 4512



Capacity: 12.5 Tons
Low Ht: 9.5"
High Ht: 18.5"
Lift: 5.875"
Screw Ext: 3.125"
Base: 6.5"x 4.187"
Qty per Case: 3
Case Wt: 18 lbs.

MODEL 4522



Capacity: 22.5 Tons
Low Ht: 10.625"
High Ht: 16.312"
Lift: 6.25"
Screw Ext: --
Base: 7.187x 5.062"
Qty per Case: 3
Case Wt: 27 lbs.

MODEL 4513



Capacity: 12.5Tons
Low Ht: 6.75"
High Ht: 13.375"
Lift: 3.75"
Screw Ext: 3"
Base: 6.5"x 4.187"
Qty per Case: 3
Case Wt: 14 lbs.

MODEL 4523



Capacity: 22.5 Tons
Low Ht: 7.125"
High Ht: 12"
Lift: 3.375"
Screw Ext: 1.562"
Base: 7-3/16" x 5.062"
Qty per Case: 3
Case Wt: 22 lbs.

20-TON CAPACITY AIR/HYDRAULIC BOTTLE JACK MODEL 5520B

- 90-180 PSI
- Factory pre-tested to 150% of rated capacity
- Safety bypass system
- Dual ram return springs
- Saddles are machine-hardened steel

Capacity: 20 Tons
Low Ht: 10.5"
High Ht: 20"
Lift: 6.25"
Screw Ext: 3.25"
Base: 9.5"x 6.5"
Ship Wt: 38 lbs.



12-TON CAPACITY AIR/HYDRAULIC BOTTLE JACK MODEL 5512B

- 90-180 PSI
- Factory pre-tested to 150% of rated capacity
- Safety bypass system
- Dual ram return springs. Saddles are machine-hardened steel

Capacity: 12 Tons
Low Ht: 10.25"
High Ht: 19.75"
Lift: 6.75"
Screw Ext: 3"
Base: 8.5"x 5"
Ship Wt: 30 lbs.



AFF SUPER DUTY Shop Presses. The welded frame and heavier gauge steel make these presses ideal for heavy-duty truck applications, spring shops, industrial, or every day shops that find themselves in need of a "step up" from a regular duty press. A movable press head assembly and included V-blocks add versatility to these work horses.

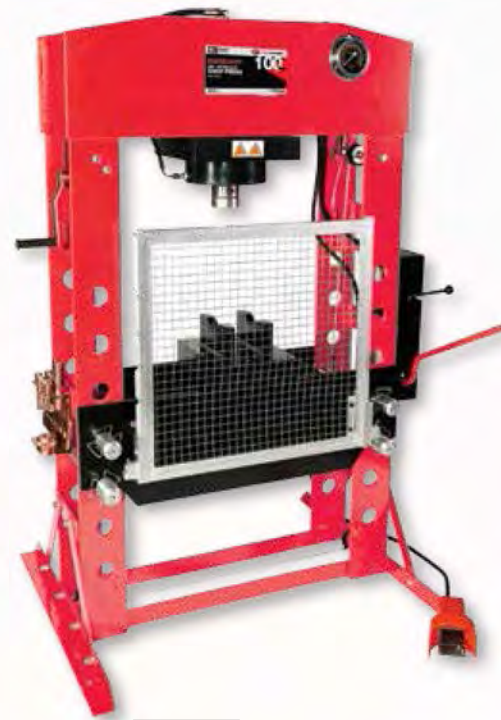

**100-TON SUPER-DUTY SHOP PRESS
MODEL 859SD**

- Welded frame for added strength
- Protective guard, combination "V" block and pressing adapter set included
- Press head moves from side to side for added pressing flexibility
- Liquid filled gauge accurately shows operator pressing force being applied
- Air pressure: 110 - 120 PSI
- HD cable winch for raising and lowering press bed
- Ship weight 1476 lbs.



| CAPACITY TON | RAM STROKE | OVERALL DIMENSIONS | BED DEPTH | BED WIDTH | THROAT DEPTH | THROAT WIDTH |
|--------------|------------|--------------------|-----------|-----------|--------------|--------------|
| 100 | 11.58" | 55"W x 84"H | 13.5" | 31" | 9" | 16.5" |



**75-TON SUPER-DUTY SHOP PRESS
MODEL 856SD**

- Welded frame for added strength
- Protective guard, combination "V" block and pressing adapter set included
- Press head moves from side to side for added pressing flexibility
- Liquid filled gauge accurately shows operator pressing force being applied
- Air pressure: 110 - 120 PSI
- HD cable winch for raising and lowering press bed
- Ship weight 1039 lbs.



| CAPACITY TON | RAM STROKE | OVERALL DIMENSIONS | BED DEPTH | BED WIDTH | THROAT DEPTH | THROAT WIDTH |
|--------------|------------|--------------------|-----------|-----------|--------------|--------------|
| 75 | 9.75" | 57"W x 77"H | 10.87" | 31.5" | 8" | 19.75" |

50 TON SUPER DUTY SHOP PRESS

MODEL 854SD

- Welded frame for added strength
- Protective guard, combination "V" block and pressing adapter set included
- Press head moves from side to side for added pressing flexibility
- Liquid filled gauge accurately shows operator pressing force being applied
- Air pressure: 110 - 120 PSI
- HD cable winch for raising and lowering press bed
- Includes multiple-use pin and press adapter set (not shown)



| Model | CAPACITY TONS | RAM STROKE | OVERALL DIMENSIONS | BED DEPTH | BED WIDTH | THROAT DEPTH | THROAT WIDTH | SHIP WEIGHT |
|-------|---------------|------------|--------------------|-----------|-----------|--------------|--------------|-------------|
| 854D | 50 | 7.75" | 54"W x 75"H | 10.125" | 28.75" | 7.25" | 16.75" | 660 lbs. |



30-TON SUPER-DUTY SHOP PRESS

MODEL 852SD

- Welded frame for added strength
- Protective guard, combination "V" block and pressing adapter set included
- Press head moves from side to side for added pressing flexibility
- Liquid filled gauge accurately shows operator pressing force being applied
- Air pressure: 110 - 120 PSI
- Includes multiple-use pin and press adapter set



| Model | CAPACITY TONS | RAM STROKE | OVERALL DIMENSIONS | BED DEPTH | BED WIDTH | THROAT DEPTH | THROAT WIDTH | SHIP WEIGHT |
|-------|---------------|------------|--------------------|-----------|-----------|--------------|--------------|-------------|
| 852D | 30 | 5.9" | 40"W x 71"H | 7.25" | 21.5" | 6.5" | 15" | 363 lbs. |

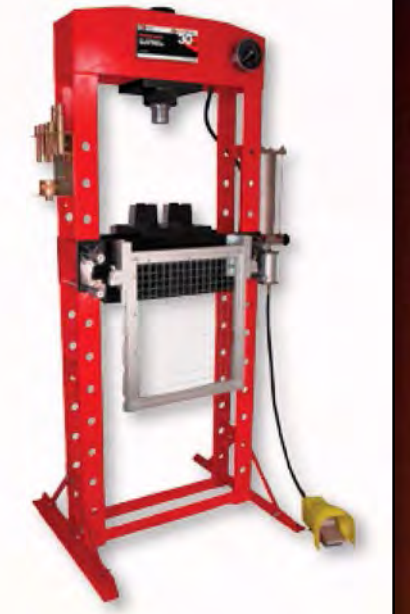
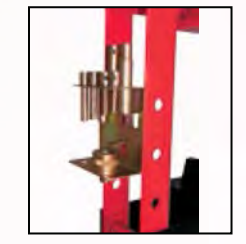

20-TON SUPER-DUTY SHOP PRESS

MODEL 850SD

- Welded frame for added strength
- Protective guard, combination "V" block and pressing adapter set included
- Press head moves from side to side for added pressing flexibility
- Liquid-filled gauge accurately shows operator pressing force being applied
- Air pressure: 110 - 120 PSI
- Includes multiple-use pin and press adapter set



| Model | CAPACITY TONS | RAM STROKE | OVERALL DIMENSIONS | BED DEPTH | BED WIDTH | THROAT DEPTH | THROAT WIDTH | SHIP WEIGHT |
|-------|---------------|------------|--------------------|-----------|-----------|--------------|--------------|-------------|
| 850D | 20 | 7.5" | 35"W x 64"H | 7" | 19.25" | 5.75" | 10.75" | 282 lbs. |

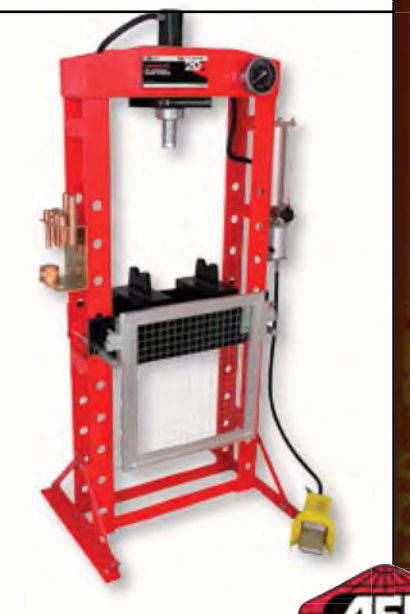
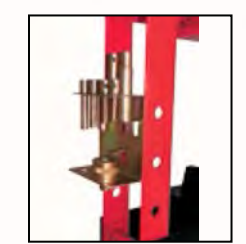

AFF Shop Presses, both bench and floor style, are used in repair shops for the removal and installation of gears, bushings and bearings, as well as with metal bending, straightening, compression and flattening applications. All AFF floor presses have "forge" tough structural steel frames and two arbor plates.

50-TON CAPACITY FLOOR PRESS

MODEL 837

- Heavy-duty vehicle and industrial use
- Winch-operated press bed with seven adjustment levels
- Two-speed hand pump provides faster travel to load while air/hydraulic pump (with overload protection) provides effort-less operation
- Frame-mounted hydraulic pressure gauge



| MODEL | CAPACITY (tons) | STROKE | SPACE INTERVAL | BED RAIL OPENING | POST OPENING | BASE WIDTH | HEIGHT | SHIP WEIGHT |
|-------|-----------------|--------|----------------|------------------|--------------|------------|--------|-------------|
| 837 | 50 | 7" | 5-1/2" | 9" | 32" | 44" | 68" | 672 lbs |

35-TON CAPACITY FLOOR PRESS

MODEL 834

- Automotive and heavy-duty use
- Two-speed hand pump provides faster travel to load while the air/hydraulic (with load protection) allows for effortless operation
- Seven bed adjustments
- Frame-mounted hydraulic pressure gauge



| MODEL | CAPACITY (tons) | STROKE | SPACE INTERVAL | BED RAIL OPENING | POST OPENING | BASE WIDTH | HEIGHT | SHIP WEIGHT |
|-------|-----------------|--------|----------------|------------------|--------------|------------|--------|-------------|
| 834 | 35 | 6-1/2" | 4-1/2" | 7-1/2" | 24" | 30" | 66" | 312 lbs. |

30-TON CAPACITY FLOOR PRESS

MODEL 832A

- Automotive and light industrial use
- Eight level bed adjustment
- 30-ton bottle jack with overload protection
- Heavy-duty return springs for fast ram retraction
- Reinforced head plate



| MODEL | CAPACITY (tons) | STROKE | SPACE INTERVAL | BED RAIL OPENING | POST OPENING | BASE WIDTH | HEIGHT | SHIP WEIGHT |
|-------|-----------------|--------|----------------|------------------|--------------|------------|--------|-------------|
| 832A | 30 | 6-1/2" | 4-1/2" | 7-1/4" | 22-1/2" | 30" | 66" | 405 lbs. |

20-TON CAPACITY FLOOR PRESS

MODEL 820A

- Automotive and light industrial use
- Eight-level bed adjustment
- 20-ton bottle jack with overload protection
- Heavy-duty return springs for fast ram retraction
- Reinforced head plate



| MODEL | CAPACITY (tons) | STROKE | SPACE INTERVAL | BED RAIL OPENING | POST OPENING | BASE WIDTH | HEIGHT | SHIP WEIGHT |
|-------|-----------------|--------|----------------|------------------|--------------|------------|--------|-------------|
| 820A | 20 | 8-1/2" | 4-1/2" | 7-1/4" | 22-1/2" | 27" | 61" | 280 lbs. |

12-TON CAPACITY FLOOR PRESS

MODEL 812

- Designed for light duty applications
- Seven-level bed adjustment
- Heavy-duty return springs for fast ram retraction



| MODEL | CAPACITY (tons) | STROKE | SPACE INTERVAL | BED RAIL OPENING | POST OPENING | BASE WIDTH | HEIGHT | SHIP WEIGHT |
|-------|-----------------|--------|----------------|------------------|--------------|------------|--------|-------------|
| 812 | 12 | 6-3/4" | 3-1/2" | 3" | 16" | 20" | 70" | 112 lbs. |

REPLACEMENT ARBOR PLATES

MODEL 812K20

Arbor plate fits Model 812 12-ton Floor Press
Ship weight 12 lbs.



MODEL 820AK7

MODEL 820AK7

Pair of arbor plates fits Model 820A 20-ton Floor Press
Ship weight 51 lbs.



MODEL 832AK12

MODEL 832AK12

Pair of arbor plates fits Model 832A 30-ton Floor Press
Ship weight 99 lbs.



AFF Power Tool Kits are used in vehicle or equipment maintenance and repair applications. Kit attachments are interchangeable with most major brands. AFF also offers a variety of pull kits for body shop use. Model 818SD comes in rugged metal carrying cases, while the 814C and 815C are packed in a strong, durable plastic case.

**20-TON COLLISION REPAIR KIT
MODEL 818SD**

- 20-ton deluxe collision repair kit used in the trucking, farm and construction industry
- 2 speed 10,000 PSI pump with safety overload extends the ram to load quickly
- 20 Ton ram with 5" stroke
- All components use a threaded connection for added strength and durability
- 5' Flexible hose comes with spring guards at both ends
- Comes with 2 metal carry boxes for added mobility and accessibility
- Ship weight 108 lbs.

Each kit includes:

- 2-Speed Hydraulic Hand Pump
- 5' Hydraulic Hose
- 20-ton Ram w/5" stroke
- 27.5" Extension Tube
- 20" Extension Tube
- 10" Extension Tube
- 5" Extension Tube
- Lock Pin
- Male Connector (3)
- Threaded Coupling (3)
- Plunger Base (2)
- Toe Lift
- Vee Head
- Wedge Head
- Serrated Saddle
- Metal Carry Case (2)



**20-TON HYDRAULIC RAM FOR 818SD
MODEL 818SD-41**

- Threaded 20-ton ram with 5" stroke
- Direct replacement for ram in the 818SD kit
- Ship weight 30 lbs.

**HYDRAULIC PUMP FOR 818SD KIT
MODEL 818SD-40**

- 2-speed 10,000 psi pump with safety overload protection
- Same unit as pump included in the 818SD kit
- Ship weight 18 lbs.

**10-TON COLLISION REPAIR KIT
MODEL 815C**

- 10-ton, Plastic case
- Ship weight 83 lbs.

**4-TON COLLISION REPAIR KIT
MODEL 814C**

- 4-ton, Plastic case
- Ship weight 43 lbs.



This Case Has Wheels

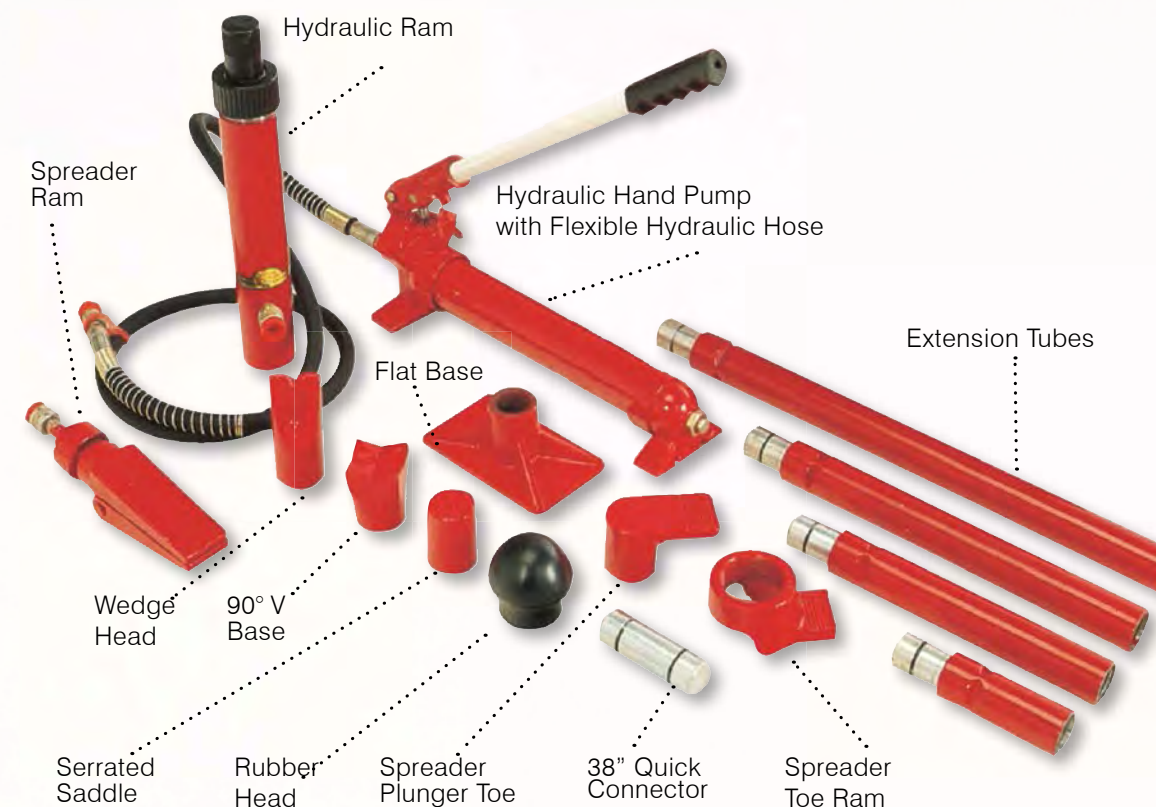

Each kit includes:

- Either the AFF Model 814-41 4-ton ram or Model 815-41 10-ton ram
- Model 814-11 spreader ram
- Either Model 814-40 or 815-40 hydraulic hand pump with overload protection
- 5", 10", 21" and 24" extension tubes
- 3-1/4" extension tube (814C only)
- Rubber head
- Wedge head
- Spreader ram plunger toes
- Serrated saddle
- Rubber-faced flat base
- 90° V-base
- Quick connector
- Model 814K42 72" hydraulic hose
- Carrying case



AFF Air/Hydraulic Foot and Hand Pumps are precision made with the highest quality material and components providing durable unit for years of service. Each unit produces 10,000 PSI with overload protection.

10-TON HAND PUMP

MODEL 815-40

- Develops up to 10,000 PSI pressure with overload protection
- 33 cu. in. oil capacity
- Exact replacement for hand pump in AFF Model 815 series 10-ton Body and Frame Repair Kits
- Works with 4KR22 hose
- Ship weight 15 lbs.



4-TON HAND PUMP

MODEL 814-40

- Develops up to 10,000 PSI pressure with overload protection
- 16 cu. in. oil capacity
- Exact replacement for hand pump in AFF Model 814 series 4-ton Body and Frame Repair Kits
- Works with 4KR22 hose
- Ship weight 11 lbs.



10-TON CAPACITY AIR/HYDRAULIC FOOT PUMP

MODEL 801

- Converts rams from manual to air/hydraulic operation
- Develops up to 10,000 PSI pressure with overload protection
- Will operate all AFF rams
- Operates at 90 to 120 PSI
- 19.95 oz. oil capacity
- 17-1/2" length
- Ship weight 12 lbs.



10-TON CAPACITY AIR/HYDRAULIC FOOT PUMP

MODEL 802

- Rugged lightweight aluminum reservoir
- Converts rams from manual to air/hydraulic operation
- Will operate all AFF rams including large diameter & multiple ram configurations
- Operates at 90 PSI and up
- Quick displacement of up to 54.08 oz. hydraulic fluid
- Develops up to 10,000 PSI pressure
- Ship weight 19 lbs.



PULL KIT WITH HOOKS

MODEL 804-09

- 10-ton Capacity
- 12" to 17" reach
- Ship Weight 11 lbs.



RAM HALF COUPLER

MODEL 4KR20

- 3/8" high flow coupler for quicker hydraulic system set-up.
- Develops 10,000 PSI capacity
- 1/4" NPT female connection
- For use with all AFF pumps and rams
- Ship weight 1 lb.



PUMP HOSE HALF COUPLER

MODEL 4KR21

- 3/8" hose
- Develops 10,000 PSI capacity
- 1/4" NPT female connection
- For use with all AFF pumps and rams
- Ship weight 1 lb.



COMPLETE RAM COUPLER

MODEL 4KR22

- Complete 3/8" quick coupler
- Develops 10,000 PSI capacity
- For use with all AFF pumps and rams
- Ship weight 1 lb.



AFF Hydraulic Rams are premium quality, designed to provide trouble-free service to meet a wide range of needs. They are used to provide 1/2 to 10 tons of reliable, concentrated force in lifting, pulling, pushing, bending and alignment applications. AFF's ram models include mini, snap-style, screw, pull, wedge and long configurations that can be used with AFF and other body and frame repair kits as well as in vehicle service facilities, farms, industry and construction.



| MODEL | CAPACITY (tons) | TYPE | STROKE | COMPRESSED LENGTH | EXTENDED LENGTH | SPRING RETURN | SHIP WGT. (lbs) |
|---------|-----------------|------------|---------|-------------------|-----------------|---------------|-----------------|
| 810-07B | 10 | Mini | 2" | 4-3/4" | 6-3/4" | Yes | 6 |
| 814-41 | 4 | Snap-style | 5" | 11" | 16" | Yes | 4 |
| 810-41 | 10 | Screw | 6" | 15" | 21" | Yes | 10 |
| 810-45 | 10 | Long | 10" | 15-3/4" | 25-3/4" | Yes | 13 |
| 812-41 | 2 | Mini | 3." | 4-3/4" | 9-1/2" | No | 2 |
| 815-41 | 10 | Snap-style | 6" | 15" | 21" | Yes | 12 |
| 804-11 | 1/2 | Wedge | NA | 1/2" | 4" | N/A | 5 |
| 804-10 | 4 | Mini | 5/8" | 1-1/2" | 2-1/4" | No | 3 |
| LRC8B | 8 | Long | 20-3/4" | 24-1/4" | 45" | N/A | 35 |
| LRC3B | 3 | Long | 20-3/4" | 24-1/4" | 45" | N/A | 25 |

Portable Power

Portable Power



13.2-GALLON DRUM BAND DOLLY**MODEL 8625**

- Designed to efficiently move 13.2-gallon drums and pails
- Adjustable band clamp holds load securely
- Four rubberized casters for directional stability
- Ship weight 8 lbs.

**55-GALLON DRUM BAND DOLLY****MODEL 8655**

- 660-lb. capacity
- Move 55-gallon steel, plastic and fiber drums easily and safely
- Heavy-duty spot-welded steel construction
- Four 3" heavy-duty swivel casters for directional stability
- 24.375" band diameter
- Ship weight 24 lbs.

**55-GALLON DRUM CRADLE****MODEL 8656**

- 660-lb. capacity
- Tip, drain and store 55-gallon drums with ease (drum not included)
- Cradle supports drum 17" off floor
- Four wheels for easy positioning
- 34" L x 21" W x 17" H
- Ship weight 24 lbs.

**PALLET JACK****MODEL 3900A**

- High-tensile steel frame with 5500 lb. capacity
- Quick hydraulics lift from 3" to 7.75"
- Large 27" x 48" platform
- Full 180° steering arc
- Durable polyurethane-coated steel wheels and entry rollers
- Three-position control lever automatically returns to neutral position
- Ship weight 228 lbs.

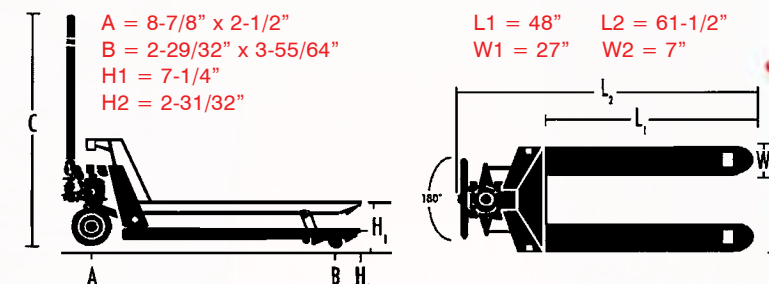
**HYDRAULIC TABLE CART****MODEL 3904**

- 1100 lb. capacity
- Foot pedal-operated table smoothly lifts and lowers engines, transmissions, heavy packages and cargo
- Lifts 32" x 19.5" table from 11" to 36"
- Heavy-duty, all-steel construction with four wheels and two wheel brakes
- Handle-mounted pressure release
- Ship weight 195 lbs.

**HEAVY-DUTY POLYPROPYLENE DRUM DOLLY****MODEL 8654**

- Handles 30 & 50 gallon capacity drums.
- 2 Steps - 18.75" diameter and 23.25" diameter
- 5 Heavy duty casters with threaded inserts prevents "tear out"
- Capacity: 660 lbs.
- Ship weight 22 lbs.



Threaded Inserts



AFF Chain, Lever and Cable Hoists are the dependable way to lift, lower, load and move a variety of heavy materials with a minimum of manual power for maximum efficiency. Their primary applications include farming, industry, machine shops, trucking and so many more.

CHAIN HOISTS

- Factory tested to 150% of rated capacity
- Rugged triple spur gear
- Safety brake to prevent slippage
- Hardened steel alloy chain for safe, smooth operation
- Forged safety hooks included

MODEL 4001
2,000 LB. CAPACITY
CHAIN HOIST



MODEL 4002
4,000 LB. CAPACITY
CHAIN HOIST



MODEL 4003
6,000 LB. CAPACITY
CHAIN HOIST



MODEL 4005
10,000 LB. CAPACITY
CHAIN HOIST



| MODEL | CAPACITY (lbs.) | LIFT (ft) | CHAIN DIAMETER | # of FALLS | # OF SAFETY HOOKS | SHIP WEIGHT |
|-------|-----------------|-----------|----------------|------------|-------------------|-------------|
| 4001 | 2,000 | 8 | 1/4" | 1 | 2 | 23 lbs. |
| 4002 | 4,000 | 10 | 1/4" | 1 | 2 | 30 lbs. |
| 4003 | 6,000 | 10 | 3/8" | 2 | 2 | 50 lbs. |
| 4005 | 10,000 | 10 | 5/16" | 2 | 2 | 91 lbs. |

MODEL 4008
3,000 LB. LEVER HOIST

- Durable steel frame
- Lightweight and easy to handle
- Guide slots to guard against jamming or slippage
- 1/4" link chain
- Two-forged safety hooks included
- Lift is 5 ft.
- 1 Fall
- Ship weight 25 lbs.



CABLE PULLERS

- Efficient for lifting, lowering, pulling & stretching applications
- Hardened steel pivot points for extra strength
- Forged safety hooks included

MODEL 30400
CABLE PULLER

- 8,000 lb. capacity
- 3/16" cable diameter
- 5.5' cable length
- Ship weight 14 lbs.



MODEL 30200
CABLE PULLER

- 4,000 lb. capacity
- 3/16" cable diameter
- 5' cable length
- Ship weight 7 lbs.

TOOL STORAGE - DIESEL TOUGH FOR DIESEL TECHS!

- MODEL 941 - 41" 8-drawer double bank chest**
- MODEL 942 - 41" 9-drawer double bank cabinet**
- MODEL 943 - 16" 3-shelf side box**

- Heavy-duty construction for tough work environments
- Designed specifically to hold tools used with diesel power, large trucks, farm equipment, earth moving implements, and heavy-duty equipment
- 125 lb. quick release ball bearing slides accommodate the bigger and heavier tools associated with large equipment repair
- Extra heavy 5"x2" caster with heavy gauge yoke and swivel for easy movement of heavy loads
- Triple-reinforced undercarriage for extra heavy load bearing capacity
- Lid has gas struts for easy opening
- Solid triple point lock protects tools from theft
- Durable powder coat paint



| MODEL | Width | Height | Depth | SHIP WEIGHT |
|-------------|--------|--------|-------|-------------|
| 941 Chest | 21.26" | 41.0" | 17.7" | 154 lbs. |
| 942 Cabinet | 40.7" | 41.6" | 18.1" | 228 lbs. |
| 9943 Shelf | 34.1" | 15.9" | 18.1" | 100 lbs. |

2 SHELF POLYPROPYLENE SHOP CART
MODEL 962

- 5" x 1" casters (2 swivel, 2 fixed)
- Convenient organizer tray
- Super strong polypropylene
- 500 lb. overall capacity.
- Tray size: 36"L x 24"W x 3" D
- 46"L x 25.5"W x 33.25"H overall
- Ship weight 51 lbs.



ADD-A-SHELF
MODEL 964

- 36" x 24"
- Ship weight 16 lbs.

2 SHELF POLYPROPYLENE SHOP CART
MODEL 961

- 5" x 1" casters (2 swivel, 2 fixed)
- Convenient organizer tray
- Super strong polypropylene
- 500 lb. overall capacity.
- Tray size: 30"L x 16"W x 3" D
- 39.75"L x 17"W x 33.25"H overall
- Ship weight 40 lbs.



ADD-A-SHELF
MODEL 963

- 30" x 16"
- Ship weight 13 lbs.



Heavy-Duty Workbenches are made of rolled edge steel (for safety) and are powdercoated to resist scratches, chips and rust. Each has sturdy 10-gauge steel worktops that can handle the weight of even the heaviest parts and assemblies. Bolt-down feet for added safety. Thick wall rectangular tubular legs create the sturdiest bench on the market. Ships in wooden crate.

HEAVY-DUTY WORKBENCH

MODEL 990

- 10-gauge rolled edge steel work top with 2" retaining wall on sides and back (1750 lb. load capacity)
- Two 12-gauge steel shelves each with a 550 lb. load capacity
- Ship weight 275 lbs.

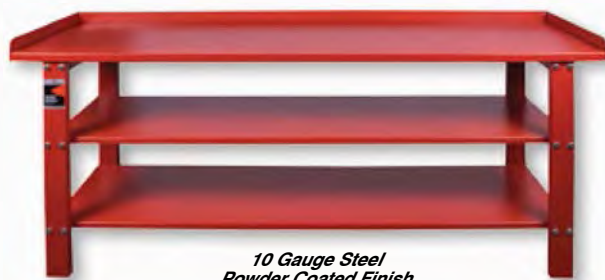

10 Gauge Steel Powder Coated Finish

| MODEL | WORKTOP CAPACITY | DRAWERS | SHELF CAPACITY | # SHELVES | LENGTH | WIDTH | HEIGHT | SHIP WEIGHT |
|-------|------------------|---------|----------------|-----------|--------|--------|--------|-------------|
| 990 | 1750 lbs. | N/A | 550 lbs. | 2 | 79" | 25.25" | 34.5" | 275 lbs. |

HEAVY-DUTY WORKBENCH

MODEL 992

- 10-gauge rolled edge steel work top with 2" retaining wall on sides and back (1750 lb. load capacity)
- Two key-lock steel drawers with full-extension, ball-bearing slides
- One 12-gauge steel shelf with a 550 lb. load capacity
- Ship weight 236 lbs.



10 Gauge Steel Powder Coated Finish

| MODEL | WORKTOP CAPACITY | DRAWERS | SHELF CAPACITY | # SHELVES | LENGTH | WIDTH | HEIGHT | SHIP WEIGHT |
|-------|------------------|---------|----------------|-----------|--------|--------|--------|-------------|
| 992 | 1750 lbs. | 2 | 550 lbs. | 1 | 59" | 25.25" | 34.5" | 236 lbs. |

HEAVY-DUTY TEARDOWN TABLE

MODEL 994

- Fluids drain through table top into a removable plastic container (included)
- Comes with locking storage drawer on ball bearing slides
- Multiple shelf location adds versatility
- Square tube leg design adds strength & stability to table top
- Large 4" heavy-duty swivel casters (2 locking)
- Table top features 1/2" rim
- Extra heavy duty construction
- Capacity: 1,000 lbs
- 47" W x 31.5" D x 39.75" H
- Ship weight 249 lbs.

Tapered table top with drain hole allows convenient fluid drainage into plastic container.



10 Gauge Steel Powder Coated Finish

| MODEL | WORKTOP CAPACITY | DRAWERS | SHELF CAPACITY | # SHELVES | LENGTH | WIDTH | HEIGHT | SHIP WEIGHT |
|-------|------------------|---------|----------------|-----------|--------|-------|--------|-------------|
| 994 | 1000 lbs. | 1 | 1500 lbs. | 1 | 48" | 31" | 40" | 249 lbs. |

5" GENERAL DUTY SWIVEL VISE

MODEL 3941

- Class 30 iron
- 30,000 lb. tensile strength castings
- Precision-machined hardened steel jaws (replaceable)
- Built-in pipe jaws
- Machine-ground anvil surface
- 360° swivel base with dual lock down handles
- Maximum opening : 5"
- Throat depth: 3"
- Net weight: 27.5 lbs.
- Ship weight: 29.7 lbs.



6" GENERAL DUTY SWIVEL VISE

MODEL 3942

- Class 30 iron
- 30,000 lb. tensile strength castings
- Precision-machined hardened steel jaws (replaceable)
- Built-in pipe jaws
- Machine-ground anvil surface
- 360° swivel base with dual lock down handles
- Maximum opening : 6"
- Throat depth: 3-1.2"
- Net weight: 41.8 lbs.
- Ship weight: 44 lbs.



8" GENERAL DUTY SWIVEL VISE

MODEL 3943

- Class 30 iron
- 30,000 lb. tensile strength castings
- Precision-machined hardened steel jaws (replaceable)
- Built-in pipe jaws
- Machine-ground anvil surface
- 360° swivel base with dual lock down handles
- Maximum opening : 8"
- Throat depth: 4"
- Net weight: 64.9 lbs.
- Ship weight: 68.2 lbs.



5" MULTI-PURPOSE SWIVEL VISE

MODEL 3944

- Class 30 iron
- 30,000 lb. tensile strength castings
- Precision-machined hardened steel jaws (replaceable)
- Built-in pipe jaws
- Machine-ground anvil surface
- 360° swivel base with dual lock down handles
- Maximum opening : 5"
- Throat depth: 2-5/8"
- Net weight: 33 lbs.
- Ship weight: 35.2 lbs.



5" HEAVY DUTY SWIVEL VISE

MODEL 3947

- Class 30 iron
- 30,000 lb. tensile strength castings
- Precision-machined hardened steel jaws (replaceable)
- Built-in pipe jaws
- Machine-ground anvil surface
- 360° swivel base with dual lock down handles
- Maximum opening : 5-1/4"
- Throat depth: 3-3/4"
- Net weight: 50.6 lbs.
- Ship weight: 52.8 lbs.



6" HEAVY DUTY SWIVEL VISE

MODEL 3948

- Class 30 iron
- 30,000 lb. tensile strength castings
- Precision-machined hardened steel jaws (replaceable)
- Built-in pipe jaws
- Machine-ground anvil surface
- 360° swivel base with dual lock down handles
- Maximum opening : 6"
- Throat depth: 4"
- Net weight: 63.8 lbs.
- Ship weight: 66 lbs.



8" BENCH GRINDER**MODEL 31520**

- Adjustable steel work rest
- 1 Standard Safety Glass, 1 Magnifying Safety Glass
- Cast aluminum base
- Large flexible work light (bulb not included)
- Water Tray
- Dust-proof switch
- 8" Grinder
- 3/4 HP Ball bearing motor 120V, 4.8 Amp 60 Hz
- 5/8" Arbor
- 1" Wheel Width
- 3,450 RPM (no load speed)
- Ship weight 33 lbs.

**6" BENCH GRINDER****MODEL 31510**

- Adjustable steel work rest
- 1 Standard Safety Glass, 1 Magnifying Safety Glass
- Cast aluminum base
- Large flexible work light (bulb not included)
- Water Tray
- Dust-proof switch
- 6" Grinder
- 1/2 HP Ball bearing motor 120V, 2.8 Amp 60 Hz
- 1/2" Arbor
- 3/4" Wheel Width
- 3,450 RPM (no load speed)
- Ship weight 21 lbs.

**ADJUSTABLE HEIGHT STAND****MODEL 31500**

- Extra large 12" x 10" steel table top reduces vibration and breakage compared to typical cast tops.
- Pre-drilled slots allow for mounting most bench grinders 5"-10".
- Heavy-duty cast iron base pre-drilled for securing
- Adjustable table height from 28" - 36"
- Ship weight 20 lbs.

**FIXED HEIGHT STAND****MODEL 31501**

- Extra large 12" x 10" steel table top reduces vibration and breakage compared to typical cast tops.
- Pre-drilled slots allow for mounting most bench grinders 5"-10".
- Heavy-duty cast iron base predrilled for securing
- Height 32"
- Ship weight 23 lbs.

**CREEPER SEAT****MODEL 3906**

- Padded, reinforced, oil-resistant vinyl seat (1-3/4" thick)
- Convenient under seat tray keeps tools and small parts handy
- 1" steel tube frame with four 2-1/2" ball-bearing casters
- Fully assembled
- 17-1/2" L x 14" W x 14" H
- Ship weight 10 lbs.

**AIR PISTON CREEPER SEAT****MODEL 3907**

- Padded, reinforced vinyl seat with air piston for efficient height adjustment to 18"
- Convenient under seat tool and parts tray
- Five 2-1/2" heavy-duty casters
- Ship weight 14 lbs.

**42" HEAVY-DUTY MECHANIC'S CREEPER****MODEL 3908**

- Longer and wider for additional working comfort
- Drop frame at shoulder for ease of movement
- Full-length, padded, oil-resistant vinyl center panel
- Six heavy-duty, dual-post casters
- 42" L x 21" W x 3-1/2" H
- Ship weight 21 lbs.

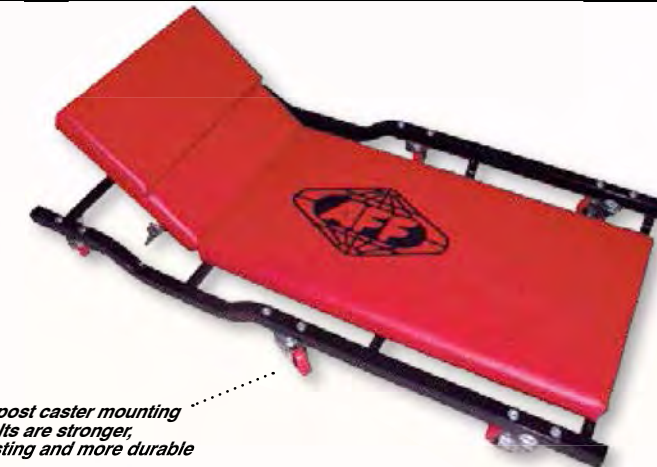

*Double post caster mounting
bolts are stronger,
longer lasting and more durable*

37" SIX-WHEEL PADDED CREEPER**MODEL 3905**

- Full-length, padded, oil-resistant vinyl center panel (1-3/4" thick)
- Additional 1-1/2" thick headrest
- Six 2-1/2" swivel casters
- 37" L x 18" W x only 3-1/2" H
- Ship weight 16 lbs.



*Double post caster mounting
bolts are stronger,
longer lasting and more durable*

AFF Parts Washers are designed for fast and efficient cleaning of vehicle parts and subassemblies. Includes durable baked enamel finish and fusible-linked fire covers for safety. Our complete line of parts washers and accessories are designed for use with water-based cleaners (aqueous) for faster, more efficient cleaning.

7-GALLON PORTABLE PARTS WASHER

MODEL 31350

- 3-1/2 gallon working capacity
- 45 GPH pump output
- Safety GFCI plug at 115V/ 0.5A
- UL Listed on complete unit
- 18-1/2" x 13-1/2" x 9" overall dimensions
- Ship weight 18 lbs.



20-GALLON HYDRA-FLOW PARTS WASHER

MODEL 31200A

- 12-gallon working capacity
- 50 GPH pump output
- Safety GFCI plug at 115V/ 0.5A
- Removable work shelf and parts basket
- UL Listed on complete unit
- 30" x 20-1/2" x 36-1/2" overall dimensions
- Ship weight 62 lbs.



40-GALLON INDUSTRIAL-DUTY PARTS WASHER

MODEL 31400

- 22-gallon working capacity
- 50 GPH pump output
- Safety GFCI plug at 110V/0.5A
- Removable work shelf and parts basket
- UL Listed on complete unit
- 45" x 21-1/4" x 35-5/8" overall dimensions
- Ship weight 107 lbs.



FLO-THRU PARTS WASHER BRUSH

MODEL PWBRUSH

- Reduces parts cleaning time by 50%
- 4" long bristles suitable for use with water-based (aqueous) cleaner, as well as petroleum-based product
- Easy attachment fitting
- Fits all AFF parts washers
- 10" L x 1-1/2" W
- Ship weight 2 lbs



AFF Grease Pumps easily move large volumes of grease in professional settings, and are engineered with tight fitting, durable components to provide years of trouble-free service.

50:1 AIR-OPERATED PORTABLE GREASE UNIT

MODEL 8600A

- For use with 5-gallon (35 lb.) containers
- 50:1 pump
- 70-100 PSI operating pressure
- Pumps up to 1.76 lbs. per minute
- 82 dB noise level
- Carrying handle
- 13' delivery hose
- 12.20" drum cover
- Control valve
- Ship weight 23 lbs.



REPLACEMENT PUMPS

MODEL 8600AP

- 50:1 Air-operated grease pump only for use with 5-gallon (35 lb.) containers.
- 70-100 PSI operating pressure
- Pumps up to 1.76 lbs. per minute
- 82dB noise level
- Ship weight 12 lbs.

MODEL 8620AP

- 50:1 Air-operated grease pump only for use with 16-gallon (120 lb.) containers.
- Ship weight 14 lbs.

50:1 AIR-OPERATED PORTABLE GREASE UNIT

MODEL 8620A

- For use with 16-gallon (120 lbs) containers
- 50:1 pump
- 70-100 PSI operating pressure
- Pumps up to 1.76 lbs. per minute
- 82 dB noise level
- 13' delivery hose
- 15.10" drum cover
- 14-1/2" follower plate
- Control valve
- Ship weight 38 lbs.



8620A

AIR-OPERATED PORTABLE GREASE UNIT WITH MODEL 8625 BAND DOLLY

MODEL 8621A

- Same as 8620A (see specs above)
- Includes 8625 Band Dolly
- Ship weight 38 lbs.

8621A is 8620A+Band Dolly

AIR-OPERATED PORTABLE GREASE UNIT WITH MODEL 4-WHEEL CART

MODEL 8622A

- Same as 8620A (see specs above)
- Includes 4-wheel cart
- Ship weight 54 lbs.



8620A

8622A is 8620A+Cart



AFF Lube Guns are dependable, durable, and heavy duty, and are meant for use in heavy duty shops, farm and agriculture, construction and other professional environments.

18V PROFESSIONAL DUTY GREASE GUN

MODEL 8008A

- 10,000 PSI
- 264 oz./min dispense rate
- 1 Hour quick charger
- Two 18-volt NiCad batteries
- Extra long 42" flex hose
- Holds 14 oz. cartridge
- Comes with heavy-duty molded carry case
- Electrical and pressure overload protection
- Ship weight 4 lbs.



PROFESSIONAL-DUTY GREASE GUN

MODEL 8000

- 10,000 PSI
- 14 oz. capacity via cartridge suction or bulk loading
- Heavy-duty, aluminum die-cast head
- Bulk loader & air bleeder valve
- Four-jaw coupler with ball check
- Ship weight 4 lbs.



STANDARD GREASE GUN

MODEL 8002

- 8,000 PSI
- Four-jaw coupler with ball check
- 14 oz. capacity via cartridge or suction
- Ship weight 4 lbs.



PISTOL-GRIP GREASE GUN

MODEL 8003

- 5,000 PSI with flexible hose
- Comfortable one-hand operation in confined spaces
- Heavy-duty aluminum die-cast head
- Four-jaw coupler with ball check
- 14 oz. capacity via cartridge or suction
- Ship weight 4 lbs.



SUCTION GUN

MODEL 8006

- Transfers gear oils into and out of gear boxes, transfer cases and differentials.
- Single piece aluminum die-cast head
- 12" flexible vinyl hose
- 16 oz. capacity
- Ship weight 2 lbs.



DELUXE MINI-PISTOL GREASE GUN

MODEL 8007

- 3,500 PSI
- One-hand operation
- Aluminum die-cast head with front and top discharge ports
- Four-jaw coupler with ball check
- 3 oz. capacity
- Ship weight 5 lbs.



PNEUMATIC GREASE GUN

MODEL 8010

- 4,800 PSI
- 14 oz. capacity via cartridge, suction or bulk loading
- Single shot with every trigger pull
- Heavy-duty aluminum die-cast head
- 40:1 pressure ratio
- Four-jaw coupler
- Bulk loader valve
- Ship weight 5 lbs.



CONTINUOUS FLOW AIR GREASE GUN

MODEL 8605

- Heavy-duty air-powered grease gun with ergonomic pistol grip
- Automatic continuous flow of grease while trigger is depressed
- Complete with 6" steel extension and 12" flexible hose with heavy-duty coupler
- Added filler nipple allows 3-way loading: bulk, filler pump, or standard 14 oz. cartridge
- Air vent for releasing air pockets
- Extra long 42" flex hose
- Holds 14 oz. cartridge
- Comes with heavy-duty molded carry case
- Ship weight 4 lbs.



Available Early 2014

COLD WEATHER GREASE GUN

MODEL 8004

- Heavy-duty grease gun for use in any climate, but specifically designed to pump in cold weather
- Large grease inlet with venturi action helps retain prime
- Double-lipped rubber follower allows use with grease cartridge or bulk without any changeover
- Drop-resistant pistol grip handle
- Capacity: 14 oz. cartridge or 500cc bulk fill
- Complete with 18" high pressure flex hose and professional 4-jaw coupler
- 7,500 PSI
- Ship weight 3.5 lbs.



Available Early 2014

GREASE FITTING KITS

MODEL 8104 & 8103

- Replacements for broken or damaged grease fittings
- Kit contains 80 individual grease fittings contained in a plastic case.
- Ship weight 1 lbs.



MODEL 8104 (Metric)

Thread spec/contents:
 M6x1: 20 straight, 10 each 90°
 M8x1: 15 straight, 10 each 90°
 M10x1: 15 straight, 10 each 90°

MODEL 8103 (SAE)

Thread spec/contents:
 1/8"-25 NPT:
 25 each straight
 10 each 45°
 10 each 90°
 1/4"-28 SAE-LT:
 15 each straight
 10 each 45°
 10 each 90°



Available Early 2014

FLUID TRANSFER GUN

MODEL 8005

- Transfers liquids from one container to another
- 8 ft. of vinyl hose (4 ft. for each valve)
- Suitable for petroleum products
- 16 oz. capacity
- Ship weight 3 lbs.



PISTOL OIL CAN

MODEL 8040

6 oz. Pistol style



LONG NECK OIL CAN

MODEL 8041

6 oz. Long neck



OIL CAN

MODEL 8042

7 oz. with 4" straight and flexible spouts



OIL CAN

MODEL 8043

10 oz. with 4" straight and flexible spouts



OIL CAN

MODEL 8044

16 oz. with 4" straight and flexible spouts



7-PC LUBRICATION KIT

MODEL 8090

- 8014: Whip hose with quick disconnect (QD) and heavy duty coupler
- 8025: Recessed QD lube adapter
- 8037: Rubber-tipped QD seal-off dispenser
- 8022: 1-1/2" narrow needle adapter (QD)
- 8034: Right angle adapter (QD)
- 8021: 90° adapter (QD)
- 8091: Needle adapter
- Cloth roll-up carrying case
- Ship weight 2 lbs.



GREASE FITTING UNBLOCKER

MODEL 8100

- Opens clogged grease fittings and loosens hardened grease joints
- Tapping tool with a hammer forces a light viscosity oil into the fitting, breaking up and removing dirt and debris
- Excellent for maintaining bearings, control arms, king pins etc.
- Built-in hand guard for operator protection
- Complete with coupler and flex hose for reaching recessed fittings
- Includes 2 spare piston seals
- Ship weight 1.5 lbs



Available Early 2014

GREASE GUN WHIP HOSES

MODEL 8012 - 12"

MODEL 8018 - 18"

- For hand-operated grease guns
- 3,500 PSI working pressure
- 11,600 PSI burst pressure
- 1/8" NPT threads



GREASE GUN WHIP HOSES

MODEL 8013 - 12"

MODEL 8019 - 18"

- Heavy duty spring guard for added durability/safety
- For hand-operated grease guns
- 3,500 PSI working pressure
- 11,600 PSI burst pressure
- 1/8" NPT threads

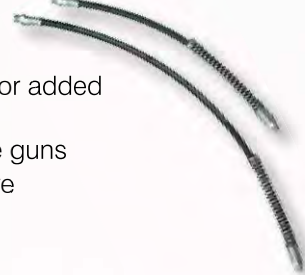

GREASE GUN WHIP HOSES

MODEL 8014 - 12"

- Quick disconnect
- Heavy duty coupler
- For hand-operated grease guns
- 3,500 PSI working pressure
- 11,600 PSI burst pressure
- 1/8" NPT threads



HIGH-PRESSURE GREASE GUN HOSES

MODEL 8612 - 12"

MODEL 8618 - 18"

- Polyamide inner tube with polyurethane sheathing
- 0.425" outer diameter
- 5,800 PSI working pressure (13,775 PSI burst)
- Zinc-plated end connections
- 1/8" NPT threads



90° LUBE ADAPTER (QD)

MODEL 8021

- Reach hidden fittings in shoulders & confined areas
- 0.24" greasing end diameter
- Locking sleeve
- For hand-operated grease guns only



1-1/2" NARROW NEEDLE ADAPTER (QD)

MODEL 8022

- Reach flush or hidden fittings
- 0.156" needle diameter
- Locking sleeve
- For hand-operated grease guns only



GREASE CONTROL VALVE

MODEL 8698

- Continuous grease flow with trigger depressed
- 1/4" NPT (f) inlet and 1/8" NPT (f) outlet threads
- For power lube equipment
- Ship weight 2 lbs.



360° "Z" SWIVELS 1/4" NPT (m) x 1/4" NPT (m)

MODEL 8687

360° "Z" SWIVELS 1/4" NPT (m) x 1/2" 27 (m)

MODEL 8686

Heavy-duty steel installed between delivery hose and grease control valve prevents hose twisting



4" NEEDLE ADAPTER (QD)

MODEL 8023

- Dispense a fine line of grease
- For hand-operated grease guns only



QUICK DISCONNECT (QD) ADAPTER

MODEL 8024

- Grease fitting on one end and 1/8" NPT threads on the other
- For hand-operated grease guns only



RECESSED LUBE ADAPTER (QD)

MODEL 8025

- For recessed fittings where hydraulic couplers can't reach
- Cup-shaped 0.22" diameter tip
- 0.31" body diameter, 3.15" length
- Locking sleeve
- For hand-operated grease guns only



1-1/2" NEEDLE ADAPTER

MODEL 8027

- Use to dispense a fine line of grease
- Reach flush or hidden hydraulic type fittings
- For hand-operated grease guns only
- 1/8" NPT threads



NEEDLE ADAPTERS

MODEL 8028 - 5/8"

- Use to dispense a fine line of grease
- Reach flush or hidden hydraulic type fittings
- For hand-operated grease guns only
- 1/8" NPT threads
- Zinc-plated end connections



NEEDLE ADAPTERS

MODEL 8029 - 6"

- Use to dispense a fine line of grease
- Reach flush or hidden hydraulic type fittings
- For hand-operated grease guns only
- 1/8" NPT threads
- Zinc-plated end connections



FINE-POINT NEEDLE ADAPTER

MODEL 8091

- For dispensing very fine line of grease
- Sharp point to inject grease into ball joints
- For hand-operated grease guns only



BULK LOADER VALVE

MODEL 8026

- Replacement valve for hand-operated grease guns only



GREASE GUN EXTENSION

MODEL 8030

- 6" length
- 1/8" NPT threads



GREASE GUN HOLDER

MODEL 8031

- Snap-action clamp for easy grease gun storage
- Standard (3,000 PSI)



HYDRAULIC COUPLER

MODEL 8033

- Professional (6,000 PSI)
- Four-jaw coupler with ball check
- For hand-operated grease guns only



HYDRAULIC COUPLER

MODEL 8032

- Standard (3,000 PSI)



RIGHT-ANGLE GREASE COUPLER

MODEL 8034

- Polyurethane seal fits perfectly on fittings
- Hardened coupler housing slot provides 90° access
- For hand-operated grease guns only
- 1/8" NPT threads



3-JAW SWIVELING COUPLER

MODEL 8035

- 360° swivel locks in any of eight 45° positions
- Adjustable coupler section
- 7,000 PSI maximum operating pressure



BEARING PACKER

MODEL 8036

- For greasing taper roller bearings with 1/2" min. inner diameter, 5" maximum outside diameter & height from 1/4" to 2"
- For hand operated or power lube equipment



SEAL-OFF DISPENSER

MODEL 8037

- For lubricating cars with grease plugs
- For hand-operated grease guns only
- Threaded 1/8" female NPT



AFF Pumps are made from quality materials and with tight tolerances, making them ideal for any serious shop. Whether pumping grease, oil, antifreeze, alcohol, or other petroleum-based products, AFF has a pump for every professional.

HIGH-VOLUME ALUMINUM ROTARY PUMP

MODEL 8071

- Delivers over one quart per revolution
- Long-lasting die-cast aluminum construction with cast aluminum Buna-N-Seals
- Powder-coated finish with zinc-plated handle and discharge spout
- Curved metal spout, suction tube and bung adapter
- Use for transfer of petroleum-based products
- Ship weight 13 lbs.



POLYPROPYLENE ROTARY BARREL PUMP

MODEL 8075

- High-density polypropylene with Ryton vanes
- Three-piece extension tube with filter and 2" bung adapter
- Use with water, water-based chemicals, 50/50 antifreeze mix, windshield washer solvents, alcohol, and petroleum-based products
- Works with DEF fluid
- Ship weight 5 lbs.



15-55 GALLON HAND ROTARY PUMP

MODEL 8070

- Cast iron pump housing with heavy-duty cast vanes and nitrile rubber seals
- Three-section 37-1/4" telescopic suction tube with interchangeable bung adapters
- Use for diesel fuel and non-corrosive petroleum-based fluids of light-to-medium viscosity
- Ship weight 14 lbs.

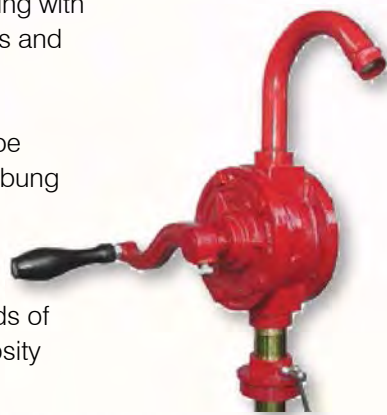

CHEMICAL PUMP - NYLON BODY

MODEL 8064

- Self-priming vertical lift pump
- Nylon pump with stainless steel plunger rod and Teflon seals.
- Complete with 2" polypropylene bung adapter
- Excellent for use with lacquer thinners, acetone, antifreeze, brake klean detergents, glycerine, water, etc.
- Fits 15-55 gallon drums
- Delivers 14 oz. per stroke
- DEF compatible
- Ship weight 3 lbs.



LEVER-ACTION 15-55 GALLON BARREL PUMP FOR GAS/DIESEL

MODEL 8080

- For use with petroleum-based fluids
- Hi-Nitrile rubber seals and packing
- Durable steel piston and foot valve
- Curved metal spout, 34-1/2" telescopic suction tube with 1-1/2" and 2" bung adapters. Use with oil-based fluids, heating oils and motor oils
- Delivers 10 oz. per stroke
- Ship weight 5 lbs.



LEVER-ACTION 15-55 GALLON ANTIFREEZE BARREL PUMP

MODEL 8081

- Same as 8080 except..
- Designed for use with 100% anti-freeze, non-corrosive chemicals, oils and petroleum-based fluids

E-Z FLOW 5-GALLON OIL PUMP

MODEL 8060

- Designed for containers with Rieke or regular openings
- High-density polyethylene pump head with steel suction tube
- Interchangeable bung adapters
- Rigid steel outlet spout and 48" discharge tube
- Use for transfer of oils, diesel fuel and 100% antifreeze
- Delivers 1 quart per 15 strokes
- Ship weight 2 lbs.

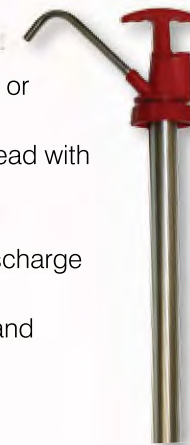

LEVER ACTION BARREL PUMP

MODEL 8055

- For use with: DEF, water-based media, detergents, soaps, antifreeze, etc.
- Designed to pump high-viscosity oils
- Anti-siphon vent cap
- Delivers 1 pint (500ml) per stroke
- Pump includes suction tube for use with 15-55 gallon drums and a 3'x3/4" flexible discharge hose
- Wetted Components: polyacetal, polypropylene, polyethylene, PVC, Viton
- Ship weight 3.4 lbs



BULK GREASE FILLER PUMP

MODEL 8038

- Fill grease guns through a bulk loader valve or with a bearing packer
- Fits 5-gallon (25-50 lb.) pails
- 11 1/8" rubber-lined follower plate
- Ship weight 5 lbs.



BUNG NUT ADAPTER

MODEL 8077

- 2" bung hole adapter converts buttress threaded drum opening to 2" NPT thread permitting easy application of various AFF pumps.
- A Buttress Thread is found on some Plastic drums used with DEF fluid, Antifreeze, Washer solvent and other liquid media.



HIGH-PRESSURE (3500 PSI) GREASE PUMP

MODEL 8039

- Fits 5-gallon (25-50 lb.) pails
- Steel construction with aluminum head and pumping chamber
- Includes 12" drum cover, 11-1/8" rubber-lined follower plate
- 48" high-pressure flexible hose with steel extension and four-jaw coupler
- Use for clean, high-pressure volume greasing of cars, trucks, equipment and machinery
- Ship weight 9 lbs.



Pail Not Included



BUCKET LEVER PUMPS

MODEL 8050

5-Gallon (25 to 50 lbs)

MODEL 8051

16-Gallon (120 lbs)

- Designed for use with differential fluids or heavier oils
- 48" fuel-resistant PVC hose with nozzle
- Delivers 1 pint per stroke
- Ship weight 5 lbs. (Model 8050)
- Ship weight 9 lbs. (Model 8051)



AFF's Full Line of Gravity and Pressurized Waste Oil Drains handle the needs of any size shop, whether servicing passenger cars and light trucks or servicing class 8 and heavy equipment.

18 GALLON WASTE OIL DRAIN WITH METAL TROLLEY

MODEL 8874

- 18-gallon capacity
- Plastic drain container
- Comes with 16.5" funnel
- Extends from 40" to 73"
- Metal trolley comes with 4 casters and pull handle for safe and easier movement around the Shop.
- Oil can be drained either by pour gravity, integrated drain valve or using integrated bung hole rotary barrel pump (not included)
- Ship weight 24 lbs.



8 GALLON WASTE OIL DRAIN WITH METAL TROLLEY

MODEL 8870

- 8-gallon capacity
- Plastic drain container
- Comes with 16.5" funnel
- Extends from 34" to 65"
- Metal trolley comes with 4 casters and pull handle for safe and easier movement around the shop.
- Ship weight 18 lbs.



18 GALLON LOW PROFILE WASTE OIL DRAIN W/PUMP

MODEL 8878

- Ideal for draining oil in trucks where a pit or hoist is not available.
- Large 18 Gallon baffled oil tank reduces "slosh" when transporting around the shop.
- Large metal screen provides greater draining area reducing the chances of spillage
- Convenient rotary hand pump
- Long steel handle for easy draining or evacuation into waste oil tanks.
- Ship weight 47 lbs.



18 GALLON LOW PROFILE ANTIFREEZE DRAIN W/PUMP

MODEL 8879

- Ideal for draining antifreeze where a pit or hoist is not available
- 18 US Gallon tank with integrated baffle captures waste fluid and minimizes spillage during transport
- Convenient rotary hand pump for fast evacuation to large collection tanks
- Aluminum pump body specifically designed to pump corrosive antifreeze
- Large metal screen keeps foreign matter out of recovery tank
- Long steel handle eases moving and positioning of drain
- Ship weight 46 lbs.



Available Early 2014

18 GALLON WASTE OIL DRAIN W/AIR EVACUATION

MODEL 8893

- 18 gallon steel recovery tank with 6' wire reinforced drain hose.
- Tank-mounted oil-level sight gauge
- Standard 14" x 5" deep drain funnel
- Extendable drain tube from 43.5" to 71"
- Pre-set pressure regulator
- Heavy-duty wheels and casters
- Ship weight 66 lbs.



24-GALLON WASTE OIL DRAIN AND EVACUATOR WITH PROBE KIT

MODEL 8895

AFF provides waste fluid recovery through traditional gravity feed and dipstick probes with specialized adapters.

- 18-gallon suction capacity
- 100-PSI shop air connected to vacuum gauge quickly creates suction
- Large 16" collection funnel (4-7/8 gallon capacity)
- Suction extraction at 1/2 gallon per minute
- 78" suction and drain hoses
- Pressurized evacuation of tank makes emptying easy
- 70.8" maximum height
- Six flexible evacuation probes and VW, Mercedes and BMW adapters
- Two air ports: 1 for pressure, 1 for vacuum
- Ship weight 93 lbs.



24-GALLON WASTE OIL DRAIN AND PRESSURIZED EVACUATOR

MODEL 8890

- Large 24 gallon steel recovery tank with 6' drain hose
- Tank-mounted oil-level sight gauge and convenient tool tray
- Standard 15-3/4" drain funnel and wide 24" funnel adapter (shown) with drain tube that extends from 54" to 79"
- Pressure regulator
- Heavy-duty wheels and casters
- Ship weight 82 lbs.



REPLACEMENT STANDARD PLASTIC FUNNEL

MODEL 8890K08

Fits AFF Model 8890 24-Gallon Waste Oil Drain and Pressurized Evacuator.

- 15-3/4" wide
- Ship weight 8 lbs.



1" DRIVE AIR IMPACT WRENCH WITH 6" EXTENDED ANVIL

MODEL 7685

- Produces 1,912 ft/lbs of hard hitting torque
- Rocking dog hammer mechanism for durability
- 6" extended anvil
- D-handle design complete with side handle
- Forward and reverse valve with position throttle settings
- Exhaust outlet directs air away from operator for maximum safety and comfort
- Three piece construction allows quick and easy maintenance
- Air inlet screen for extended motor life
- For maximum performance we recommend 90-120 PSI air pressure
- Ideal for truck and tractor tire work, agricultural and general shop applications



SPECIFICATIONS:

Square Drive: 1" w 6" Anvil
 Max. Torque: 1,912 ft/lbs.
 Working Torque: 1,500-1,650 ft/ lbs
 Free Speed 4,000 RPM
 Avg. Air Consumption: 10 CFM
 Housing: Aluminum
 Weight 28.73 lbs.

1/2" DRIVE AIR IMPACT WRENCH WITH 2" EXTENDED ANVIL

MODEL 7665

- Steel hammer casing offers greater protection
- Conventional forward/reverse switch enables quick directional changes.
- Adjustable throttle settings for maximum control
- Hammer and anvil constructed of tungsten and titanium alloy to provide longer service life.



SPECIFICATIONS:

Square Drive: 1/2"
 Max. Torque (Ft. - Lbs.): Forward 550, Reverse 550
 Working Torque(Ft. - Lbs.):Forward 550, Reverse 550
 Free Speed R.P.M. 7,000
 Standard Bolt Capacity: M16
 Weight 5.5lbs.
 Avg. Air Consumption: 8 CFM

1/2" AIR HOSE REEL

MODEL 761

- Mounting base is slotted and roller arm has 5 positions for multiple mounting configurations.
- Heavy steel construction adds durability and longer life cycles
- Rubber air hose with heavy-duty crimping and spring guard ensure longevity
- Automatic return via heavy-duty sealed spring with 8 locking stops, roller guide and ball stop
- 1/2" x 50'
- 1/2" NPT
- 300 PSI maximum pressure
- Ship weight 53 lbs.



3/8" AIR HOSE REEL

MODEL 760

- Mounting base is slotted and roller arm has 5 positions for multiple mounting configurations.
- Heavy steel construction adds durability and longer life cycles
- Rubber air hose with heavy-duty crimping and spring guard ensure longevity
- Automatic return via heavy-duty sealed spring with 8 locking stops, roller guide and ball stop
- 3/8" x 50'
- 1/4" NPT
- 300 PSI maximum pressure
- Ship weight 40 lbs.



WHEEL BEARING LOCKNUT SOCKETS

Locknut Sockets

- Machine welded 3/4" drive plate
- Precision engineered for an exact fit
- High tensile-strength steel for added durability in high-volume applications
- Powder-coated finish for added rust protection
- Use with a heavy-duty ratchet, breaker bar or torque wrench
- Fits applications requiring hexagonal 6-point, hexagonal rounded 6-point and octagonal 8-point
- Label is double thick laser etched
- Precision-welded drive strap
- Ships in easy stock shelf box

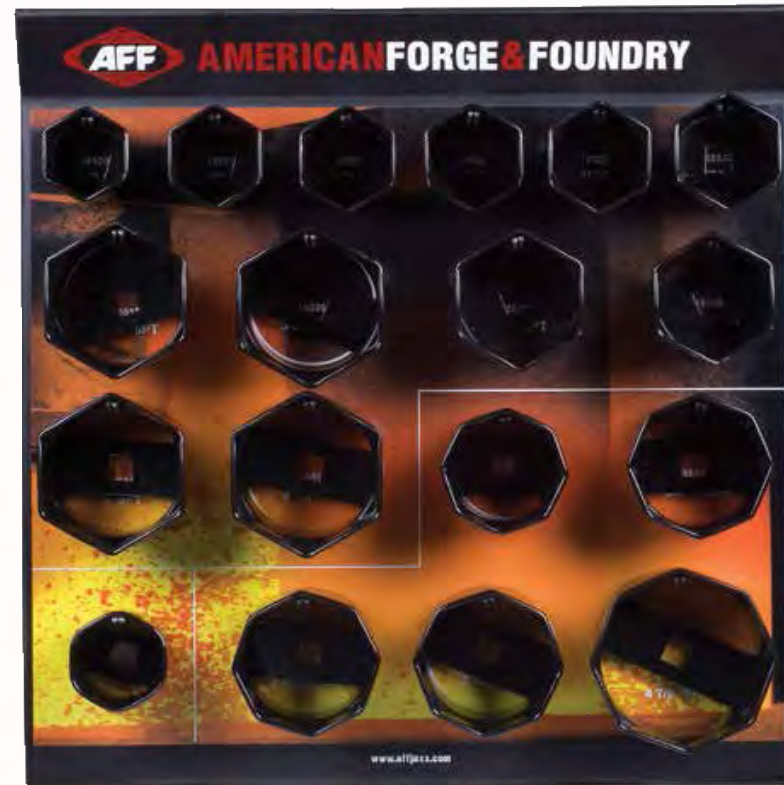

Axle Nut Display Model 18500P



| AFF # | Description | AFF # | Description | AFF # | Description |
|--------|----------------|--------|---------------|--------|------------------------|
| 18501 | 2-3/32"(6pt.) | *18514 | 4" (6pt.) | *18527 | 3-13/16" (8pt.) |
| 18502 | 2-3/8"(6pt.) | *18515 | 4-1/8" (6pt.) | *18528 | 2-9/16"(6pt) |
| 18503 | 2-3/8"(8pt.) | 18516 | 4-3/8"(6pt.) | *18532 | 2-7/8"(6pt.) |
| *18504 | 2-9/16" (6pt.) | 18517 | 4-3/8"(8pt.) | 18533 | 2-7/8"(8pt) |
| 18505 | 2-9/16"(8pt.) | 18518 | 4-7/8"(6pt.) | 18534 | 3-1/8"(6pt.) |
| 18506 | 3" (6pt.) | *18519 | 4-7/8"(8pt.) | 18535 | 3-1/8"(8pt.) |
| 18507 | 3" (8pt.) | *18520 | 2-1/4" (6pt.) | 18536 | 2-3/8"(6R) |
| *18508 | 3-1/4" (6pt.) | *18521 | 2-1/2"(6pt.) | 18537 | 2-3/4"(8pt.) |
| *18509 | 3-1/4" (8pt.) | *18522 | 2-5/8" (6pt.) | 18538 | 4-1/2"(8pt.) |
| *18510 | 3-1/2" (6pt.) | *18523 | 2-3/4" (6pt.) | 18539 | 5-1/4"(6pt.) |
| 18511 | 3-1/2"(8pt.) | 18524 | 3-3/8" (8pt.) | 18540 | 4-1/8"(8pt.) |
| *18512 | 3-7/8"(6pt.) | *18525 | 3-3/4" (8pt.) | 18541 | 4-13/16"(8pt.) |
| *18513 | 3-7/8"(8pt.) | *18526 | 3-3/4" (6pt.) | | * SKU's in the display |



WARRANTY

American Forge & Foundry, Inc. (AFF) warrants, to the final purchaser, all equipment distributed by AFF to be entirely free from operating defects in material and workmanship for a period of one year. If a jack or related equipment is determined to be defective during the period, AFF, at its option, will repair or replace without charge provided that the equipment is shipped, transportation charges prepaid, with proof of purchase, to AFF or to an authorized Field Service Depot designated by AFF.

This warranty does not apply to products damaged by accident, overload, misuse or abuse, nor does it apply to any product, which has been modified, altered or used with special attachments other than those expressly recommended by AFF. There are no other warranties express or implied, and Seller specifically disclaims any warranty of merchantability or of fitness for any particular purpose.

The Seller's sole obligation, which shall represent the Buyer's sole and exclusive remedy, shall be to repair or at the Seller's option to replace any product or part determined to be defective as aforesaid. In no event shall the Seller be liable for any special, direct, indirect, incidental, consequential or other damages of a similar nature, including, without limitation, loss of profits or of production time, or loss of expenses of any nature, incurred by the Buyer or any Third party.

MODEL NUMBER INDEX

| | | | | | |
|-------------------|----|----------------|----|--------------|----|
| 4KR20 | 36 | 761 | 56 | 961 | 41 |
| 4KR21 | 36 | 801 | 36 | 962 | 41 |
| 4KR22 | 36 | 802 | 36 | 963 | 41 |
| 200T | 5 | 804-09 | 36 | 964 | 41 |
| 200TK40 | 7 | 804-10 | 37 | 990 | 42 |
| 200TK42 | 7 | 804-11 | 37 | 992 | 42 |
| 206 | 5 | 810-07B | 37 | 994 | 42 |
| 208 | 5 | 810-41 | 37 | 2145 | 15 |
| 210 | 5 | 810-45 | 37 | 2158 | 14 |
| 350GT | 4 | 812 | 33 | 2195B | 15 |
| 350GTK23 | 7 | 812-41 | 37 | 3120 | 9 |
| 350GTK41 | 7 | 812K20 | 33 | 3125 | 8 |
| 350SS | 4 | 814-40 | 36 | 3130 | 9 |
| 350SSK24 | 7 | 814-41 | 37 | 3135 | 8 |
| 300T | 4 | 814C | 35 | 3140 | 9 |
| 390 | 7 | 815-40 | 36 | 3160 | 16 |
| 535A | 11 | 815-41 | 37 | 3165 | 6 |
| 536 | 11 | 815C | 35 | 3167 | 6 |
| 544 | 10 | 818SD | 34 | 3171 | 17 |
| 544EXT | 10 | 818SD-40 | 34 | 3172 | 17 |
| 545SD | 13 | 818SD-41 | 34 | 3178 | 16 |
| 546SD | 13 | 820A | 33 | 3180 | 16 |
| 547SD | 13 | 820AK7 | 33 | 3181 | 17 |
| 548SD | 12 | 832A | 32 | 3190B | 15 |
| 549SD | 12 | 832AK12 | 33 | 3190SS | 14 |
| 551 | 10 | 834 | 32 | 3192B | 14 |
| 565E | 11 | 837 | 32 | 3198 | 16 |
| 565E-HANDLE | 11 | 850SD | 31 | 3233A | 26 |
| 565E1 | 11 | 852SD | 31 | 3303 | 25 |
| 571B | 24 | 854SD | 31 | 3306 | 25 |
| 573B | 24 | 856SD | 30 | 3305A | 25 |
| 582 | 23 | 859SD | 30 | 3309A | 25 |
| 583 | 23 | 941 | 41 | 3310A | 25 |
| 584 | 23 | 942 | 41 | 3312B | 25 |
| 760 | 56 | 943 | 41 | 3314 | 25 |

MODEL NUMBER INDEX. Cont'd

| | | | | | |
|--------------|----|-------------|----|-----------------------|----|
| 3320A | 26 | 4008 | 40 | 8075 | 52 |
| 3315A | 26 | 4512 | 29 | 8077 | 53 |
| 3318 | 26 | 4513 | 29 | 8079 | 53 |
| 3340SD | 27 | 4522 | 29 | 8080 | 52 |
| 3342SD | 27 | 4523 | 29 | 8081 | 52 |
| 3344SD | 27 | 7665 | 56 | 8090 | 50 |
| 3400A | 20 | 7685 | 56 | 8091 | 51 |
| 3420SD | 27 | 5512B | 29 | 8100 | 50 |
| 3502 | 28 | 5520B | 29 | 8103 | 49 |
| 3504 | 28 | 8000 | 48 | 8104 | 49 |
| 3506 | 28 | 8002 | 48 | 8600A | 47 |
| 3506C | 28 | 8003 | 48 | 8600AP | 47 |
| 3508 | 28 | 8004 | 49 | 8605 | 49 |
| 3512 | 28 | 8005 | 49 | 8612 | 50 |
| 3514 | 28 | 8006 | 48 | 8618 | 50 |
| 3520 | 28 | 8007 | 48 | 8620A | 47 |
| 3522 | 28 | 8008A | 48 | 8620AP | 47 |
| 3530 | 28 | 8010 | 48 | 8621A | 47 |
| 3550 | 28 | 8012 | 50 | 8622A | 47 |
| 3577 | 21 | 8013 | 50 | 8625 | 38 |
| 3582 | 22 | 8014 | 50 | 8654 | 39 |
| 3584 | 22 | 8018 | 50 | 8655 | 38 |
| 3586B | 23 | 8019 | 50 | 8656 | 38 |
| 3590A | 21 | 8021 | 50 | 8686 | 50 |
| 3591 | 21 | 8022 | 50 | 8687 | 50 |
| 3595A | 21 | 8023 | 51 | 8698 | 50 |
| 3596 | 20 | 8024 | 51 | 8870 | 54 |
| 3598 | 20 | 8025 | 51 | 8874 | 54 |
| 3700 | 18 | 8026 | 51 | 8878 | 54 |
| 3749 | 19 | 8027 | 51 | 8879 | 54 |
| 3751 | 19 | 8028 | 51 | 8890 | 55 |
| 3752 | 19 | 8029 | 51 | 8890K08 | 55 |
| 3753 | 19 | 8030 | 51 | 8893 | 55 |
| 3754 | 19 | 8031 | 51 | 8895 | 55 |
| 3757 | 19 | 8032 | 51 | 30200 | 40 |
| 3900A | 39 | 8033 | 51 | 30400 | 40 |
| 3904 | 39 | 8034 | 51 | 31200A | 46 |
| 3905 | 45 | 8035 | 51 | 31350 | 46 |
| 3906 | 45 | 8036 | 51 | 31400 | 46 |
| 3907 | 45 | 8037 | 51 | 31500 | 44 |
| 3908 | 45 | 8038 | 53 | 31501 | 44 |
| 3911A | 21 | 8039 | 53 | 31510 | 44 |
| 3912A | 21 | 8040 | 49 | 31520 | 44 |
| 3917 | 6 | 8041 | 49 | 35014P | 7 |
| 3941 | 43 | 8042 | 49 | LOCKNUT SOCKETS | 57 |
| 3942 | 43 | 8043 | 49 | LRC3B | 37 |
| 3943 | 43 | 8044 | 49 | LRC8B | 37 |
| 3944 | 43 | 8050 | 53 | PWBRUSH | 46 |
| 3947 | 43 | 8051 | 53 | | |
| 3948 | 43 | 8055 | 53 | | |
| 4001 | 40 | 8060 | 53 | | |
| 4002 | 40 | 8064 | 52 | | |
| 4003 | 40 | 8070 | 52 | | |
| 4005 | 40 | 8071 | 52 | | |





American Forge & Foundry
P.O. Box 59
Guilderland Center, NY 12085
Phone: 800-255-0555
Fax: 518-861-0099
www.affjaxx.com
[sales @affjaxx.com](mailto:sales@affjaxx.com)